

HDCVI Standalone DVR User's Manual

V1.5.0

Table of Contents

1	FEATURES AND SPECIFICATIONS	1
1.1	Overview	1
1.2	Features.....	1
1.3	Specifications	2
1.3.1	HCVR General 720P 1U Series	2
1.3.2	HCVR General 2-HDD 720P 1.5U Series.....	6
1.3.3	HCVR General 4-HDD 720P 1.5U Series.....	10
1.3.4	HCVR General 720P 2U Series	14
1.3.5	HCVR Advanced 1080P 1U Series	19
1.3.6	HCVR Advanced 1080P 1.5U Series.....	23
1.3.7	HCVR Advanced 1080P 2U Series	27
2	OVERVIEW AND CONTROLS.....	32
2.1	Front Panel.....	32
2.1.1	1U Series.....	32
2.1.2	1.5U Series	34
2.1.3	2U Series.....	35
2.2	Rear Panel.....	38
2.2.1	4/8-Channel HCVR General 720P 1U Series and 4-Channel HCVR Advanced 1080P 1U Series	38
2.2.2	16-Channel HCVR General 720P 1U Series and 8-Channel HCVR Advanced 1080P 1U Series	39
2.2.3	HCVR General 2-HDD 720P 1.5U Series.....	41
2.2.4	HCVR General 4-HDD 720P 1.5U Series and HCVR Advanced 1080P 1.5U Series	42
2.2.5	HCVR General 4-HDD 720P 2U Series and HCVR Advanced 1080P 2U Series..	44
2.3	Connection Sample.....	46

2.3.1	4/8-Channel HCVR General 720P 1U Series and 4-Channel HCVR Advanced 1080P 1U Series	47
2.3.2	16-Channel HCVR General 720P 1U Series and 8-Channel HCVR Advanced 1080P 1U Series	47
2.3.3	HCVR General 2-HDD 720P 1.5U Series/HCVR General 4-HDD 720P 1.5U Series /HCVR Advanced 1080P 1.5U Series	48
2.3.4	HCVR General 720P 2U Series and HCVR Advanced 1080P 2U Series.....	49
2.4	Remote Control	50
2.5	Mouse Control	52
2.6	Virtual Keyboard & Front Panel.....	54
2.6.1	Virtual Keyboard	54
2.6.2	Front Panel.....	54
3	INSTALLATION AND CONNECTIONS	55
3.1	Check Unpacked DVR.....	55
3.2	About Front Panel and Real Panel	55
3.2.1	HDD Installation.....	55
3.2.2	1U Series.....	55
3.2.3	1.5U series	56
3.2.4	2U series	57
3.2.5	Rack Installation	58
3.3	Connecting Power Supply	58
3.4	Connecting Video Input and Output Devices	58
3.4.1	Connecting Video Input.....	58
3.4.2	Connecting Video Output.....	59
3.5	Connecting Audio Input & Output, Bidirectional Audio.....	59
3.5.1	Audio Input.....	59
3.5.2	Audio Output	59

3.6	Alarm Input and Output Connection	60
3.6.1	Alarm Input and Output Details	60
3.6.2	Alarm Input Port.....	62
3.6.3	Alarm Output Port.....	63
3.7	RS485	64
3.8	Other Interfaces.....	65
4	OVERVIEW OF NAVIGATION AND CONTROLS	66
4.1	Boot up and Shutdown	66
4.1.1	Boot up	66
4.1.2	Shutdown	66
4.1.3	Auto Resume after Power Failure	66
4.1.4	Replace Button Battery	66
4.2	Startup Wizard.....	67
4.3	Manual Record	69
4.3.1	Live Viewing.....	69
4.4	Right-Click Menu.....	71
4.4.1	Window Switch.....	72
4.4.2	PTZ Control.....	72
4.4.3	Color	77
4.4.4	Search	79
4.4.5	Manual Record.....	79
4.4.6	Alarm Output.....	79
4.4.7	Video Matrix	79
4.5	Navigation Bar	79
4.5.1	Main Menu.....	80
4.5.2	Output Screen.....	80
4.5.3	Favorites.....	80
4.5.4	Tour	80
4.5.5	PTZ.....	80

4.5.6	Color	80
4.5.7	Search	80
4.5.8	Alarm Status.....	80
4.5.9	Channel Info.....	81
4.5.10	Network.....	81
4.5.11	HDD Manager.....	81
4.5.12	USB Manager.....	81
4.6	USB Device Auto Pop-up	81
4.7	Main Menu	82
4.8	Operation	82
4.8.1	Search	82
4.8.2	Backup.....	90
4.8.3	Shut Down.....	92
4.9	Information.....	92
4.9.1	System Info	92
4.9.2	Event.....	96
4.9.3	Network	96
4.9.4	Log.....	99
4.10	Setting.....	101
4.10.1	Camera	101
4.10.2	Network.....	105
4.10.3	Event.....	123
4.10.4	Storage	137
4.10.5	System.....	147
5	WEB OPERATION	167
5.1	Network Connection.....	167
5.2	Login.....	167
5.3	LAN Mode.....	168

5.4	Real-time Monitor.....	170
5.5	PTZ.....	171
5.6	Image/Relay-out.....	172
5.6.1	Image.....	172
5.6.2	Relay output.....	172
5.7	WAN Login.....	173
5.8	Setup.....	174
5.8.1	Camera.....	174
5.8.2	Network	179
5.8.3	Event.....	195
5.8.4	Storage	203
5.8.5	Setting	208
5.9	Information.....	221
5.9.1	Version	221
5.9.2	Log.....	221
5.9.3	Connection Log.....	222
5.9.4	Online User	223
5.10	Playback	223
5.11	Alarm.....	227
5.12	Log out.....	228
5.13	Un-install Web Control.....	228
6	PROFESSIONAL SURVEILLANCE SYSTEM.....	229
7	FAQ	230

APPENDIX A	HDD CAPACITY CALCULATION	236
APPENDIX B	COMPATIBLE BACKUP DEVICES	238
Appendix B-1	Compatible USB list	238
Appendix B-2	Compatible SD Card list.....	239
Appendix B-3	Compatible Portable HDD list.....	239
Appendix B-4	Compatible USB DVD List	239
Appendix B-5	Compatible SATA DVD List.....	239
Appendix B-6	Compatible SATA HDD List.....	240
APPENDIX C	COMPATIBLE CD/DVD BURNER LIST.....	244
APPENDIX D	COMPATIBLE DISPLAYER LIST	245
APPENDIX E	COMPATIBLE SWITCHER	246
APPENDIX F	COMPATIBLE WIRELESS MOUSE LIST.....	247
APPENDIX G	EARTHING	248
APPENDIX H	TOXIC OR HAZARDOUS MATERIALS OR ELEMENTS.....	254

Welcome

Thank you for purchasing our DVR!

This user's manual is designed to be a reference tool for the installation and operation of your system.

Here you can find information about this series standalone DVR features and functions.

Before installation and operation please read the following safeguards and warnings carefully!

Important Safeguards and Warnings

1 . Electrical safety

All installation and operation here should conform to your local electrical safety codes.

The product must be grounded to reduce the risk of electric shock.

We assume no liability or responsibility for all the fires or electric shock caused by improper handling or installation.

2 . Transportation security

Heavy stress, violent vibration or water splash are not allowed during transportation, storage and installation.

3 . Installation

Keep upwards. Handle with care.

Do not apply power to the DVR before completing installation.

Do not place objects on the DVR.

4 . Qualified engineers needed

All the examination and repair work should be done by the qualified service engineers.

We are not liable for any problems caused by unauthorized modifications or attempted repair.

5 . Environment

The DVR should be installed in a cool, dry place away from direct sunlight, inflammable, explosive substances and etc.

6. Accessories

Be sure to use all the accessories recommended by manufacturer.

Before installation, please open the package and check all the components are included.

Contact your local retailer ASAP if something is broken in your package.

7. Lithium battery

Improper battery use may result in fire, explosion, or personal injury!

When replace the battery, please make sure you are using the same model!

1 FEATURES AND SPECIFICATIONS

1.1 Overview

The standalone series DVR is an excellent digital monitor product designed for security field.

It adopts embedded Linux OS to maintain reliable operation. Popular H.264 compression algorithm and G.711 audio compression technology realize high quality, low bit stream. Unique frame by frame play function is suitable for detailed analysis. It has various functions such as record, playback, monitor at the same time and can guarantee audio video synchronization. This series product has advanced technology and strong network data transmission function.

This series device adopts embedded design to achieve high security and reliability. It can work in the local end, and at the same time, when connecting it to the professional surveillance software (PSS), it can connect to the security network to realize strong network and remote monitor function.

This series product can be widely used in various areas such as banking, telecommunication, electric power, interrogation, transportation, intelligent resident zone, factory, warehouse, resources, and water conservancy.

1.2 Features

This series product has the following features:

- **Real-time surveillance**

Support VGA port and HDMI port. Realize the surveillance through displayer. Support HDMI, VGA, and TV output at the same time.

- **Storage function**

Special data format to guarantee data security and can remove the risk of the vicious data modification. Support digital watermark.

- **Compression format**

Support multiple-channel audio and video. An independent hardware decodes the audio and video signal from each channel to maintain video and audio synchronization.

- **Backup function**

Support backup operation via USB port (such as U disk, portable HDD, burner)
Client-end user can download the file to local HDD to backup via network.

- **Record & playback function**

Support each channel real-time record independently, and at the same time it can support search, forward play, network monitor, record search, download and etc.

Support various playback modes: slow play, fast play, backward play and frame by frame play.

Support time title overlay so that you can view event accurate occurred time

Support customized zoom function during the preview.

- **Network operation**

Support network remote real-time monitor, remote record search and remote PTZ control.

- **Alarm activation function**

Several relay alarm outputs to realize alarm activation and on-site light control.

The alarm input port and output has the protection circuit to guarantee device safety.

- **Communication port**

RS485 port can realize alarm input and PTZ control.

RS232 port can connect to keyboard to realize central control, and can also connect to PC COM to upgrade system and realize maintenance, and matrix control.

Standard Ethernet port can realize network access function.

The dual-network port has the multiple-access, fault-tolerance, load-balance setup mode.

- **PTZ control**

Support PTZ decoder via RS485.

- **Intelligent operation**

Mouse operation function

In the menu, support copy and paste setup function

- **UPNP (Universal Plug and Play)**

Establish mapping connection between LAN and WAN via UPNP protocol.

Slight function differences may be found due to different series.

1.3 Specifications

1.3.1 HCVR General 720P 1U Series

	Parameter	4-ch	8-ch	16-ch
System	Main Processor	High-performance industrial embedded micro controller		
	OS	Embedded LINUX		
	System Resources	Multiplex operations: Multiple-channel record, multiple-channel playback and network operation simultaneously		
	Interface	User-friendly graphical user interface		
	Input Devices	USB mouse		

	Input Method	Arabic number, English character, donation and extension Chinese (optional)		
	Shortcut Function	Copy/paste operation, USB mouse right-key shortcut menu, double click USB mouse to switch screen.		
Compression Standard	Video Compression	H.264		
	Audio Compression	G711A, G711U, PCM		
Video monitor	Video Input	4-CH composite video input: (NTSC/PAL) BNC (1.0VBP- P, B75Ω)	8-CH composite video input: (NTSC/PAL) BNC (1.0VBP- P, B75Ω)	16-CH composite video input: (NTSC/PAL) BNC (1.0VBP- P, B75Ω)
	Video Output	1-ch PAL/NTSC, BNC (1.0VP- P, 75Ω) composite video signal output. 1-ch VGA output. 1-ch HDMI output. Support TV/VGA/HDMI video output at the same time.		
	Video Standard	720P/25, 720P/30, 720P/50, 720P/60		
	Record Speed	Real-time Mode: PAL 1f/s to 25f/s per channel and NTSC 1f/s to 30f/s per channel		
	Video Partition	1/4windows(Optional)	1/4/8/9 windows	1/4/8/9/16 windows
	Monitor Touring	Support monitor tour functions such as alarm, motion detection, and schedule auto control.		
	Resolution (PAL/NTSC)	Real-time monitor: 720P 1280*720		
		Playback: 1/16-ch: 720P 1280x720, D1 704x576/704x480, HD1 352x576/352x480, 2CIF 704x288/704x240, CIF 352x288/ 352x240, QCIF 176x144/176x120		
		Support dual streams: extra stream resolution D1 704x576/704x480 CIF 352x288/ 352x240, QCIF 176x144/176x120		
	Image Quality	6-level image quality (Adjustable)		
	Privacy mask	Support one privacy mask of user-defined size in full screen. Support max 4 zones.		
Image Information	Channel information, time information and privacy mask zone.			
TV Adjust	Adjust TV output zone suitable to anamorphic video.			

	Channel Lock	Cover secret channel with blue screen though system is encoding normally. Screen-lock function to prevent unauthorized user seeing secret video.		
	Channel Information	Channel name, recording status, screen lock status, video loss status and motion detection status are shown on the bottom left of display screen.		
	Color Configuration	Hue, brightness, contrast, saturation and gain setup for each channel.		
Audio	Audio Input	4-ch 200-2000mv 10KΩ(BNC)		
	Audio Output	1-ch audio output 200-3000mv 5KΩ(BNC)		
	Bidirectional Audio	Reuse the AUDIO IN of the first channel and AUDIO OUT.		
Hard disk	Hard Disk	2 built-in SATA ports. Support 2 HDDs.		
	One HDD Capacity	Max 4T		
	Hard Disk Occupation	Audio: PCM 28.8MByte/h Video: 56-900MByte/h		
Record and playback	Recording Mode	Manual recording, motion detection recording, schedule recording and alarm recording Priority: Manual recording> alarm recording>motion detection recording>schedule recording.		
	Storage Mode	Support channel record quota setup		
	Recording Length	1 to 120 minutes single record duration (Default setup is 60 minutes)		
	Playback Repeat Way	When hard disk is full, system can overwrite previous video file.		
	Record Search	Various search engines such as time, type and channel.		
	Playback Mode	Various fast play, slow play speeds, manual frame by frame playback and reverse play mode.		
	Various File Switch Ways	Can switch to previous or next file or any file in current play list. Can switch to file on other channel of the same time. (If there is a file) Support file continuous play, when file is end system auto plays the next file in the current channel		
	Playback Way	Support mark playback		
	Multi-channel Playback	Support 1/4-channel modes	Support 1/4/8-channel modes	Support 1/4/8-channel modes
	Window Zoom	Switch between self-adaptive screen/full screen when playback		

	Partial Enlargement	When in one-window full-screen playback mode, you can select any zone to activate partial enlargement function.		
Backup function	Backup Mode	HDD backup		
		Support peripheral USB backup device. (Flash disk, portable disk, USB burner and etc.)		
		Does not support external eSATA device backup		
		Support network download and backup		
Network Function	Network control	View monitor channel remotely.		
		DVR configuration through client-end and web browser		
		Upgrade via client or browser to realize remote maintenance.		
		View alarm information such as external alarm, motion detection and video loss via client.		
		Support network PTZ lens control		
		File download backup and playback		
		Multiple devices share information via corresponding software such as professional surveillance software (PSS)		
		Duplex transparent COM		
		Network alarm input and output		
		Zero-channel encoding		
		Bidirectional audio.		
Motion Detection and Alarm	Motion Detection	Zone setup: support 396((PAL 22×18, NTSC 22×15)) detection zones. Various sensitivity levels. Alarm can activate record or external alarm or screen message prompt.		
	Video Loss	Alarm can activate external alarm or screen message prompt.		
	External Alarm	Support record activation function or activate external alarm or screen message in specified period.		
	Manual Alarm Control	Enable or disable alarm input channel Simulate alarm signal to specific alarm output channel.		
	Alarm Input	4-ch alarm input (NO/NC)	8-ch alarm input(NO/NC)	16-ch alarm input (NO/NC)
	Alarm Output	3-channel relay output.		
	Alarm Relay	30VDC 2A, 125VAC 1A (activation alarm)		
Interface	USB Interface	2 USB 2.0 ports.		
	Network connection	1 RJ45 10M/100M/1000M self-adaptable Ethernet port		
	RS485	1 RS485 port. PTZ control port Support various PTZ control protocols.		
	RS232	Ordinary COM (Debug),keyboard connection and transparent serial port(COM input and output via network)		
	RS422	RS422 port		

System Information	Hard Disk Information	Display HDD current status
	Data Stream Statistics	Data stream statistics for each channel (in wave mode)
	Log statistics	Backup to 1024 log files. Support various search engines such as time and type.
	Version	Display version information: channel amount, alarm input and output amount, system version and release date.
	On-line user	Display current on-line user
User Management	User Management	Multi-lever user management; various management modes Integrated management for local user, serial port user and network user. Configurable user power.
		Support user /group and its corresponding rights modification. No limit to the user or group amount.
	Password Authentication	Password modification Administrator can modify other user's password.
		Account lock strategy Five times login failure in thirty minutes may result in account lock.
Upgrade		Web browser, client-end and update tool.
Login, Logout and Shutdown		Password login protection to guarantee safety
		User-friendly interface when login. Provide the following options: Logout /shutdown/ restart.
		Right authentication when shut down to make sure only those proper people can turn off DVR
General Parameter	Power	DC 12V
	Power Consumption	≤25W (With adapter, exclude HDD)
	Working Temperature	-10℃ — +55℃
	Working Humidity	10%—90%
	Air Pressure	86kpa—106kpa
	Dimension	1U standard industrial case. 375(W) x280(D) x50(H)mm
	Weight	1.5—2.5KG (Exclude HDD)
	Installation Mode	Desktop installation

1.3.2 HCVR General 2-HDD 720P 1.5U Series

	Parameter	4-ch	8-ch	16-ch
	Main Processor	High-performance industrial embedded micro controller		

System	OS	Embedded LINUX		
	System Resources	Multiplex operations: Multiple-channel record, multiple-channel playback and network operation simultaneously		
	Interface	User-friendly graphical user interface		
	Input Devices	USB mouse		
	Input Method	Arabic number, English character, donation and extension Chinese (optional)		
	Shortcut Function	Copy/paste operation, USB mouse right-key shortcut menu, double click USB mouse to switch screen.		
Compression Standard	Video Compression	H.264		
	Audio Compression	G711A, G711U, PCM		
Video monitor	Video Input	4-CH composite video input: (NTSC/PAL) BNC (1.0VBP- P, B75Ω)	8-CH composite video input: (NTSC/PAL) BNC (1.0VBP- P, B75Ω)	16-CH composite video input: (NTSC/PAL) BNC (1.0VBP- P, B75Ω)
	Video Output	1-ch PAL/NTSC, BNC (1.0VP- P, 75Ω) composite video signal output. 1-ch VGA output. 1-ch HDMI output. Support TV/VGA/HDMI video output at the same time.		
	Video Standard	720P/25, 720P/30, 720P/50, 720P/60		
	Record Speed	Real-time Mode: PAL 1f/s to 25f/s per channel and NTSC 1f/s to 30f/s per channel		
	Video Partition	1/4windows(Option al)	1/4/8/9 windows	1/4/8/9/16 windows
	Monitor Touring	Support monitor tour functions such as alarm, motion detection, and schedule auto control.		
	Resolution (PAL/NTSC)	Real-time monitor: 720P 1280*720		
		Playback: 1/16-ch: 720P 1280x720, D1 704x576/704x480, HD1 352x576/352x480, 2CIF 704x288/704x240, CIF 352x288/ 352x240, QCIF 176x144/176x120		
		Support dual streams: extra stream resolution D1 704x576/704x480 CIF 352x288/ 352x240, QCIF 176x144/176x120		
Image Quality	6-level image quality (Adjustable)			
Privacy mask	Support one privacy mask of user-defined size in full screen. Support max 4 zones.			

	Image Information	Channel information, time information and privacy mask zone.
	TV Adjust	Adjust TV output zone suitable to anamorphic video.
	Channel Lock	Cover secret channel with blue screen though system is encoding normally. Screen-lock function to prevent unauthorized user seeing secret video.
	Channel Information	Channel name, recording status, screen lock status, video loss status and motion detection status are shown on the bottom left of display screen.
	Color Configuration	Hue, brightness, contrast, saturation and gain setup for each channel.
Audio	Audio Input	4-ch 200-2000mv 10KΩ(BNC)
	Audio Output	1-ch audio output 200-3000mv 5KΩ(BNC)
	Bidirectional Audio	Reuse the AUDIO IN of the first channel and AUDIO OUT.
Hard disk	Hard Disk	2 built-in SATA ports. Support 2 HDDs.
	One HDD Capacity	Max 4T
	Hard Disk Occupation	Audio: PCM 28.8MByte/h Video: 56-900MByte/h
Record and playback	Recording Mode	Manual recording, motion detection recording, schedule recording and alarm recording Priority: Manual recording> alarm recording>motion detection recording>schedule recording.
	Storage Mode	Support channel record quota setup
	Recording Length	1 to 120 minutes single record duration (Default setup is 60 minutes)
	Playback Repeat Way	When hard disk is full, system can overwrite previous video file.
	Record Search	Various search engines such as time, type and channel.
	Playback Mode	Various fast play, slow play speeds, manual frame by frame playback and reverse play mode.
	Various File Switch Ways	Can switch to previous or next file or any file in current play list. Can switch to file on other channel of the same time. (If there is a file) Support file continuous play, when file is end system auto plays the next file in the current channel
Playback Way	Support mark playback	

	Multi-channel Playback	Support 1/4-channel modes	Support 1/4/8-channel modes	Support 1/4/8/16-channel modes
	Window Zoom	Switch between self-adaptive screen/full screen when playback		
	Partial Enlargement	When in one-window full-screen playback mode, you can select any zone to activate partial enlargement function.		
Backup function	Backup Mode	HDD backup		
		Support peripheral USB backup device. (Flash disk, portable disk, USB burner and etc.)		
		Does not support external eSATA device backup		
		Support network download and backup		
Network Function	Network control	View monitor channel remotely.		
		DVR configuration through client-end and web browser		
		Upgrade via client or browser to realize remote maintenance.		
		View alarm information such as external alarm, motion detection and video loss via client.		
		Support network PTZ lens control		
		File download backup and playback		
		Multiple devices share information via corresponding software such as professional surveillance software (PSS)		
		Duplex transparent COM		
		Network alarm input and output		
		Zero-channel encoding		
		Bidirectional audio.		
Motion Detection and Alarm	Motion Detection	Zone setup: support 396((PAL 22x18, NTSC 22x15)) detection zones. Various sensitivity levels. Alarm can activate record or external alarm or screen message prompt.		
	Video Loss	Alarm can activate external alarm or screen message prompt.		
	External Alarm	Support record activation function or activate external alarm or screen message in specified period.		
	Manual Alarm Control	Enable or disable alarm input channel Simulate alarm signal to specific alarm output channel.		
	Alarm Input	4-ch alarm input (NO/NC)	8-ch alarm input(NO/NC)	16-ch alarm input (NO/NC)
	Alarm Output	3-channel relay output.		
	Alarm Relay	30VDC 2A, 125VAC 1A (activation alarm)		
Interface	USB Interface	2 USB 2.0 ports.		
	Network connection	1 RJ45 10M/100M/1000M self-adaptable Ethernet port		
	RS485	1 RS485 port. PTZ control port Support various PTZ control protocols.		

	RS232	Ordinary COM (Debug),keyboard connection and transparent serial port(COM input and output via network)
	RS422	RS422 port
System Information	Hard Disk Information	Display HDD current status
	Data Stream Statistics	Data stream statistics for each channel (in wave mode)
	Log statistics	Backup to 1024 log files. Support various search engines such as time and type.
	Version	Display version information: channel amount, alarm input and output amount, system version and release date.
	On-line user	Display current on-line user
User Management	User Management	Multi-lever user management; various management modes Integrated management for local user, serial port user and network user. Configurable user power.
		Support user /group and its corresponding rights modification. No limit to the user or group amount.
	Password Authentication	Password modification Administrator can modify other user's password.
		Account lock strategy Five times login failure in thirty minutes may result in account lock.
Upgrade		Web browser, client-end and update tool.
Login, Logout and Shutdown		Password login protection to guarantee safety
		User-friendly interface when login. Provide the following options: Logout /shutdown/ restart.
		Right authentication when shut down to make sure only those proper people can turn off DVR
General Parameter	Power	DC 12V
	Power Consumption	≤25W (With adapter, exclude HDD)
	Working Temperature	-10℃ – +55℃
	Working Humidity	10%—90%
	Air Pressure	86kpa—106kpa
	Dimension	1.5U standard industrial case. 440(W) x410(D) x70(H)mm
	Weight	1.5—2.5KG (Exclude HDD)
	Installation Mode	Desktop installation

1.3.3 HCVR General 4-HDD 720P 1.5U Series

	Parameter	4-ch	8-ch	16-ch
System	Main Processor	High-performance industrial embedded micro controller		
	OS	Embedded LINUX		
	System Resources	Multiplex operations: Multiple-channel record, multiple-channel playback and network operation simultaneously		
	Interface	User-friendly graphical user interface		
	Input Devices	USB mouse		
	Input Method	Arabic number, English character, donation and extension Chinese (optional)		
	Shortcut Function	Copy/paste operation, USB mouse right-key shortcut menu, double click USB mouse to switch screen.		
Compression Standard	Video Compression	H.264		
	Audio Compression	G711A, G711U, PCM		
Video monitor	Video Input	4-CH composite video input: (NTSC/PAL) BNC (1.0VBP- P, B75Ω)	8-CH composite video input: (NTSC/PAL) BNC (1.0VBP- P, B75Ω)	16-CH composite video input: (NTSC/PAL) BNC (1.0VBP- P, B75Ω)
	Video Output	1-ch PAL/NTSC, BNC (1.0VP- P, 75Ω) composite video signal output. 1-ch VGA output. 1-ch HDMI output. Support TV/VGA/HDMI video output at the same time.		
	Video Standard	720P/25, 720P/30, 720P/50, 720P/60		
	Record Speed	Real-time Mode: PAL 1f/s to 25f/s per channel and NTSC 1f/s to 30f/s per channel		
	Video Partition	1/4 windows(Optional)	1/4/8/9 windows	1/4/8/9/16 windows
	Monitor Touring	Support monitor tour functions such as alarm, motion detection, and schedule auto control.		
	Resolution (PAL/NTSC)	Real-time monitor: 720P 1280*720		
		Playback: 1/16-ch: 720P 1280x720, D1 704x576/704x480, HD1 352x576/352x480, 2CIF 704x288/704x240, CIF 352x288/ 352x240, QCIF 176x144/176x120		
		Support dual streams: extra stream resolution D1 704x576/704x480 CIF 352x288/ 352x240, QCIF 176x144/176x120		
Image Quality	6-level image quality (Adjustable)			

	Privacy mask	Support one privacy mask of user-defined size in full screen. Support max 4 zones.
	Image Information	Channel information, time information and privacy mask zone.
	TV Adjust	Adjust TV output zone suitable to anamorphic video.
	Channel Lock	Cover secret channel with blue screen though system is encoding normally. Screen-lock function to prevent unauthorized user seeing secret video.
	Channel Information	Channel name, recording status, screen lock status, video loss status and motion detection status are shown on the bottom left of display screen.
	Color Configuration	Hue, brightness, contrast, saturation and gain setup for each channel.
Audio	Audio Input	4-ch 200-2000mv 10KΩ(BNC)
	Audio Output	1-ch audio output 200-3000mv 5KΩ(BNC)
	Bidirectional Audio	Reuse the AUDIO IN of the first channel and AUDIO OUT.
Hard disk	Hard Disk	4 built-in SATA port. Support 4 HDDs.
	One HDD Capacity	Max 4T
	Hard Disk Occupation	Audio: PCM 28.8MByte/h Video: 56-900MByte/h
Record and playback	Recording Mode	Manual recording, motion detection recording, schedule recording and alarm recording Priority: Manual recording> alarm recording>motion detection recording>schedule recording.
	Storage Mode	Support channel record quota setup
	Recording Length	1 to 120 minutes single record duration (Default setup is 60 minutes)
	Playback Repeat Way	When hard disk is full, system can overwrite previous video file.
	Record Search	Various search engines such as time, type and channel.
	Playback Mode	Various fast play, slow play speeds, manual frame by frame playback and reverse play mode.
	Various File Switch Ways	Can switch to previous or next file or any file in current play list. Can switch to file on other channel of the same time. (If there is a file) Support file continuous play, when file is end system auto plays the next file in the current channel

	Playback Way	Support mark playback		
	Multi-channel Playback	Support 1/4-channel modes	Support 1/4/8-channel modes	Support 1/4/8-channel modes
	Window Zoom	Switch between self-adaptive screen/full screen when playback		
	Partial Enlargement	When in one-window full-screen playback mode, you can select any zone to activate partial enlargement function.		
Backup function	Backup Mode	HDD backup		
		Support peripheral USB backup device. (Flash disk, portable disk, USB burner and etc.)		
		Support external eSATA device backup		
		Support network download and backup		
Network Function	Network control	View monitor channel remotely.		
		DVR configuration through client-end and web browser		
		Upgrade via client or browser to realize remote maintenance.		
		View alarm information such as external alarm, motion detection and video loss via client.		
		Support network PTZ lens control		
		File download backup and playback		
		Multiple devices share information via corresponding software such as professional surveillance software (PSS)		
		Duplex transparent COM		
		Network alarm input and output		
		Zero-channel encoding		
Bidirectional audio.				
Motion Detection and Alarm	Motion Detection	Zone setup: support 396((PAL 22×18, NTSC 22×15)) detection zones. Various sensitivity levels. Alarm can activate record or external alarm or screen message prompt.		
	Video Loss	Alarm can activate external alarm or screen message prompt.		
	External Alarm	Support record activation function or activate external alarm or screen message in specified period.		
	Manual Alarm Control	Enable or disable alarm input channel Simulate alarm signal to specific alarm output channel.		
	Alarm Input	4-ch alarm input (NO/NC)	8-ch alarm input(NO/NC)	16-ch alarm input (NO/NC)
	Alarm Output	6-channel relay output. (Including one controllable DC 12V output)		
	Alarm Relay	30VDC 2A, 125VAC 1A (activation alarm)		
Interface	USB Interface	3 USB 2.0 ports.		
	Network connection	1 RJ45 10M/100M/1000M self-adaptable Ethernet port		
	RS485	1 RS485 port. PTZ control port Support various PTZ control protocols.		

	RS232	1 RS232 port. Ordinary COM (Debug), keyboard connection and transparent serial port (COM input and output via network)
	RS422	1 RS422 port
System Information	Hard Disk Information	Display HDD current status
	Data Stream Statistics	Data stream statistics for each channel (in wave mode)
	Log statistics	Backup to 1024 log files. Support various search engines such as time and type.
	Version	Display version information: channel amount, alarm input and output amount, system version and release date.
	On-line user	Display current on-line user
User Management	User Management	Multi-level user management; various management modes Integrated management for local user, serial port user and network user. Configurable user power.
		Support user /group and its corresponding rights modification. No limit to the user or group amount.
	Password Authentication	Password modification Administrator can modify other user's password.
		Account lock strategy Five times login failure in thirty minutes may result in account lock.
Upgrade		Web browser, client-end and update tool.
Login, Logout and Shutdown		Password login protection to guarantee safety
		User-friendly interface when login. Provide the following options: Logout /shutdown/ restart.
		Right authentication when shut down to make sure only those proper people can turn off DVR
General Parameter	Power	AC90~264V 50+2% Hz (Max 75W power)
	Power Consumption	≤40W (With adapter, exclude HDD)
	Working Temperature	-10°C – +55°C
	Working Humidity	10% – 90%
	Air Pressure	86kpa – 106kpa
	Dimension	1.5U standard industrial case. 440(W) x410(D) x70(H)mm
	Weight	4.5 – 5.5KG (Exclude HDD)
	Installation Mode	Desktop/Rack installation

1.3.4 HCVR General 720P 2U Series

	Parameter	4-ch	8-ch	16-ch
System	Main Processor	High-performance industrial embedded micro controller		
	OS	Embedded LINUX		
	System Resources	Multiplex operations: Multiple-channel record, multiple-channel playback and network operation simultaneously		
	Interface	User-friendly graphical user interface		
	Input Devices	USB mouse		
	Input Method	Arabic number, English character, donation and extension Chinese (optional)		
	Shortcut Function	Copy/paste operation, USB mouse right-key shortcut menu, double click USB mouse to switch screen.		
Compression Standard	Video Compression	H.264		
	Audio Compression	G711A, G711U, PCM		
Video monitor	Video Input	4-CH composite video input: (NTSC/PAL) BNC (1.0VBP- P, B75Ω)	8-CH composite video input: (NTSC/PAL) BNC (1.0VBP- P, B75Ω)	16-CH composite video input: (NTSC/PAL) BNC (1.0VBP- P, B75Ω)
	Video Output	1-ch PAL/NTSC, BNC (1.0VP- P, 75Ω) composite video signal output. 1-ch VGA output. 1-ch HDMI output. Support TV/VGA/HDMI video output at the same time.		
	Video Standard	720P/25, 720P/30, 720P/50, 720P/60		
	Record Speed	Real-time Mode: PAL 1f/s to 25f/s per channel and NTSC 1f/s to 30f/s per channel		
	Video Partition	1/4 windows(Optional)	1/4 windows	1/4/8/9/16windows
	Monitor Touring	Support monitor tour functions such as alarm, motion detection, and schedule auto control.		
	Resolution (PAL/NTSC)	Real-time monitor: 720P 1280*720		
		Playback: 1/16-ch: 720P 1280x720, D1 704x576/704x480, HD1 352x576/352x480, 2CIF 704x288/704x240, CIF 352x288/ 352x240, QCIF 176x144/176x120		
		Support dual streams: extra stream resolution D1 704x576/704x480 CIF 352x288/ 352x240, QCIF 176x144/176x120		
Image Quality	6-level image quality (Adjustable)			

	Privacy mask	Support one privacy mask of user-defined size in full screen. Support max 4 zones.		
	Image Information	Channel information, time information and privacy mask zone.		
	TV Adjust	Adjust TV output zone suitable to anamorphic video.		
	Channel Lock	Cover secret channel with blue screen though system is encoding normally. Screen-lock function to prevent unauthorized user seeing secret video.		
	Channel Information	Channel name, recording status, screen lock status, video loss status and motion detection status are shown on the bottom left of display screen.		
	Color Configuration	Hue, brightness, contrast, saturation and gain setup for each channel.		
Audio	Audio Input	4-ch 200-2000mv 10KΩ(BNC)	8-ch 200-2000mv 10KΩ(BNC)	16-ch 200-2000mv 10KΩ(BNC)
	Audio Output	1-ch audio output 200-3000mv 5KΩ(BNC)		
	Bidirectional Audio	Reuse the AUDIO IN of the first channel and AUDIO OUT.		
Hard disk	Hard Disk	8 built-in SATA port. Support 8 HDDs.		
	One HDD Capacity	Max 4T		
	Hard Disk Occupation	Audio: PCM 28.8MByte/h Video: 56-900MByte/h		
Record and playback	Recording Mode	Manual recording, motion detection recording, schedule recording and alarm recording Priority: Manual recording> alarm recording>motion detection recording>schedule recording.		
	Storage Mode	Support channel record quota setup		
	Recording Length	1 to 120 minutes single record duration (Default setup is 60 minutes)		
	Playback Repeat Way	When hard disk is full, system can overwrite previous video file.		
	Record Search	Various search engines such as time, type and channel.		
	Playback Mode	Various fast play, slow play speeds, manual frame by frame playback and reverse play mode.		

	Various File Switch Ways	Can switch to previous or next file or any file in current play list. Can switch to file on other channel of the same time. (If there is a file) Support file continuous play, when file is end system auto plays the next file in the current channel		
	Playback Way	Support mark playback		
	Multi-channel Playback	Support 1/4-channel modes	Support 1/4/8-channel modes	Support 1/4/8-channel modes
	Window Zoom	Switch between self-adaptive screen/full screen when playback		
	Partial Enlargement	When in one-window full-screen playback mode, you can select any zone to activate partial enlargement function.		
Backup function	Backup Mode	HDD backup		
		Support peripheral USB backup device. (Flash disk, portable disk, USB burner and etc.)		
		Support external eSATA device backup		
		Support network download and backup		
Network Function	Network control	View monitor channel remotely.		
		DVR configuration through client-end and web browser		
		Upgrade via client or browser to realize remote maintenance.		
		View alarm information such as external alarm, motion detection and video loss via client.		
		Support network PTZ lens control		
		File download backup and playback		
		Multiple devices share information via corresponding software such as professional surveillance software (PSS)		
		Duplex transparent COM		
		Network alarm input and output		
		Zero-channel encoding		
Bidirectional audio.				
Motion Detection and Alarm	Motion Detection	Zone setup: support 396((PAL 22x18, NTSC 22x15)) detection zones. Various sensitivity levels. Alarm can activate record or external alarm or screen message prompt.		
	Video Loss	Alarm can activate external alarm or screen message prompt.		
	External Alarm	Support record activation function or activate external alarm or screen message in specified period.		
	Manual Alarm Control	Enable or disable alarm input channel Simulate alarm signal to specific alarm output channel.		
	Alarm Input	4-ch alarm input (NO/NC)	8-ch alarm input(NO/NC)	16-ch alarm input (NO/NC)
	Alarm Output	6-channel relay output. (Including one controllable DC 12V output)		
	Alarm Relay	30VDC 2A, 125VAC 1A (activation alarm)		

Interface	USB Interface	4 USB 2.0 ports.
	Network connection	Two RJ45 10M/100M/1000M self-adaptable Ethernet ports
	RS485	1 RS485 port. PTZ control port Support various PTZ control protocols.
	RS232	1 RS232 port. Ordinary COM (Debug), keyboard connection and transparent serial port(COM input and output via network)
	RS422	RS422
System Information	Hard Disk Information	Display HDD current status
	Data Stream Statistics	Data stream statistics for each channel (in wave mode)
	Log statistics	Backup to 1024 log files. Support various search engines such as time and type.
	Version	Display version information: channel amount, alarm input and output amount, system version and release date.
	On-line user	Display current on-line user
User Management	User Management	Multi-lever user management; various management modes Integrated management for local user, serial port user and network user. Configurable user power.
		Support user /group and its corresponding rights modification. No limit to the user or group amount.
	Password Authentication	Password modification Administrator can modify other user's password.
		Account lock strategy Five times login failure in thirty minutes may result in account lock.
Upgrade		Web browser, client-end and update tool.
Login, Logout and Shutdown		Password login protection to guarantee safety
		User-friendly interface when login. Provide the following options: Logout /shutdown/ restart.
		Right authentication when shut down to make sure only those proper people can turn off DVR
General Parameter	Power	AC90~264V 50+2% Hz (Max 75W power)
	Power Consumption	≤60W (With adapter, exclude HDD)
	Working Temperature	-10℃ — +55℃
	Working Humidity	10%—90%
	Air Pressure	86kpa—106kpa
	Dimension	2U standard industrial case. 440(W) x460(D) x89(H)mm

	Weight	7.0—8.0KG (Exclude HDD)
	Installation Mode	Desktop/Rack installation

1.3.5 HCVR Advanced 1080P 1U Series

	Parameter	4-ch	8-ch
System	Main Processor	High-performance industrial embedded micro controller	
	OS	Embedded LINUX	
	System Resources	Multiplex operations: Multiple-channel record, multiple-channel playback and network operation simultaneously	
	Interface	User-friendly graphical user interface	
	Input Devices	USB mouse	
	Input Method	Arabic number, English character, donation and extension Chinese (optional)	
	Shortcut Function	Copy/paste operation, USB mouse right-key shortcut menu, double click USB mouse to switch screen.	
Compression Standard	Video Compression	H.264	
	Audio Compression	G711A, G711U, PCM	
Video monitor	Video Input	4-CH composite video input: (NTSC/PAL) BNC (1.0VBP- P, B75Ω)	8-CH composite video input: (NTSC/PAL) BNC (1.0VBP- P, B75Ω)
	Video Output	1-ch PAL/NTSC, BNC (1.0VP- P, 75Ω) composite video signal output. 1-ch VGA output. 1-ch HDMI output. Support TV/VGA/HDMI video output at the same time.	
	Video Standard	1080P25, 1080P30, 720P/25, 720P/30, 720P/50, 720P/60	
	Record Speed	Real-time Mode: PAL 1f/s to 25f/s per channel and NTSC 1f/s to 30f/s per channel	
	Video Partition	1/4 windows(Optional)	1/4/8/9 windows
	Monitor Touring	Support monitor tour functions such as alarm, motion detection, and schedule auto control.	
	Resolution (PAL/NTSC)	Real-time monitor: 1080P 1920*1080 Playback: 1/16-ch: 1080P 1920*1080, 720P 1280x720, D1 704x576/704x480, HD1 352x576/352x480, 2CIF 704x288/704x240, CIF 352x288/ 352x240, QCIF 176x144/176x120	

		Support dual streams: extra stream resolution D1 704x576/704x480 CIF 352x288/ 352x240, QCIF 176x144/176x120
	Image Quality	6-level image quality (Adjustable)
	Privacy mask	Support one privacy mask of user-defined size in full screen. Support max 4 zones.
	Image Information	Channel information, time information and privacy mask zone.
	TV Adjust	Adjust TV output zone suitable to anamorphic video.
	Channel Lock	Cover secret channel with blue screen though system is encoding normally. Screen-lock function to prevent unauthorized user seeing secret video.
	Channel Information	Channel name, recording status, screen lock status, video loss status and motion detection status are shown on the bottom left of display screen.
	Color Configuration	Hue, brightness, contrast, saturation and gain setup for each channel.
Audio	Audio Input	4-ch 200-2000mv 10KΩ(BNC)
	Audio Output	1-ch audio output 200-3000mv 5KΩ(BNC)
	Bidirectional Audio	Reuse the AUDIO IN of the first channel and AUDIO OUT.
Hard disk	Hard Disk	2 built-in SATA port. Support 2 HDDs.
	One HDD Capacity	Max 4T
	Hard Disk Occupation	Audio: PCM 28.8MByte/h Video: 56-900MByte/h
Record and playback	Recording Mode	Manual recording, motion detection recording, schedule recording and alarm recording Priority: Manual recording> alarm recording>motion detection recording>schedule recording.
	Storage Mode	Support channel record quota setup
	Recording Length	1 to 120 minutes single record duration (Default setup is 60 minutes)
	Playback Repeat Way	When hard disk is full, system can overwrite previous video file.
	Record Search	Various search engines such as time, type and channel.
	Playback Mode	Various fast play, slow play speeds, manual frame by frame playback and reverse play mode.

	Various File Switch Ways	Can switch to previous or next file or any file in current play list. Can switch to file on other channel of the same time. (If there is a file) Support file continuous play, when file is end system auto plays the next file in the current channel	
	Playback Way	Support mark playback	
	Multi-channel Playback	Support 1/4-channel modes	Support 1/4/8-channel modes
	Window Zoom	Switch between self-adaptive screen/full screen when playback	
	Partial Enlargement	When in one-window full-screen playback mode, you can select any zone to activate partial enlargement function.	
Backup function	Backup Mode	HDD backup	
		Support peripheral USB backup device. (Flash disk, portable disk, USB burner and etc.)	
		Does not support external eSATA device backup	
		Support network download and backup	
Network Function	Network control	View monitor channel remotely.	
		DVR configuration through client-end and web browser	
		Upgrade via client or browser to realize remote maintenance.	
		View alarm information such as external alarm, motion detection and video loss via client.	
		Support network PTZ lens control	
		File download backup and playback	
		Multiple devices share information via corresponding software such as professional surveillance software (PSS)	
		Duplex transparent COM	
		Network alarm input and output	
		Zero-channel encoding	
Bidirectional audio.			
Motion Detection and Alarm	Motion Detection	Zone setup: support 396((PAL 22x18, NTSC 22x15)) detection zones. Various sensitivity levels. Alarm can activate record or external alarm or screen message prompt.	
	Video Loss	Alarm can activate external alarm or screen message prompt.	
	External Alarm	Support record activation function or activate external alarm or screen message in specified period.	
	Manual Alarm Control	Enable or disable alarm input channel Support analog alarm signal to specific alarm output channel.	
	Alarm Input	4-ch alarm input (NO/NC)	8-ch alarm input (NO/NC)
	Alarm Output	3-channel relay output.	
	Alarm Relay	30VDC 2A, 125VAC 1A (activation alarm)	
	USB Interface	2 USB 2.0 ports.	

Interface	Network connection	1 RJ45 10M/100M/1000M self-adaptable Ethernet port
	RS485	1 RS485 port. PTZ control port Support various PTZ control protocols.
	RS232	RS232 port. Ordinary COM (Debug), keyboard connection and transparent serial port(COM input and output via network)
System Information	Hard Disk Information	Display HDD current status
	Data Stream Statistics	Data stream statistics for each channel (in wave mode)
	Log statistics	Backup to 1024 log files. Support various search engines such as time and type.
	Version	Display version information: channel amount, alarm input and output amount, system version and release date.
	On-line user	Display current on-line user
User Management	User Management	Multi-lever user management; various management modes Integrated management for local user, serial port user and network user. Configurable user power.
		Support user /group and its corresponding rights modification. No limit to the user or group amount.
	Password Authentication	Password modification Administrator can modify other user's password.
		Account lock strategy Five times login failure in thirty minutes may result in account lock.
Upgrade		Web browser, client-end and update tool.
Login, Logout and Shutdown		Password login protection to guarantee safety
		User-friendly interface when login. Provide the following options: Logout /shutdown/ restart.
		Right authentication when shut down to make sure only those proper people can turn off DVR
General Parameter	Power	DC 12V
	Power Consumption	≤25W (With adapter, exclude HDD)
	Working Temperature	-10°C – +55°C
	Working Humidity	10% – 90%
	Air Pressure	86kpa – 106kpa
	Dimension	1U standard industrial case. 375(W) x280(D) x50(H)mm
	Weight	1.5 – 2.5KG (Exclude HDD)

	Installation Mode	Desktop installation
--	-------------------	----------------------

1.3.6 HCVR Advanced 1080P 1.5U Series

	Parameter	4-ch	8-ch	
System	Main Processor	High-performance industrial embedded micro controller		
	OS	Embedded LINUX		
	System Resources	Multiplex operations: Multiple-channel record, multiple-channel playback and network operation simultaneously		
	Interface	User-friendly graphical user interface		
	Input Devices	USB mouse		
	Input Method	Arabic number, English character, donation and extension Chinese (optional)		
	Shortcut Function	Copy/paste operation, USB mouse right-key shortcut menu, double click USB mouse to switch screen.		
Compression Standard	Video Compression	H.264		
	Audio Compression	G711A, G711U, PCM		
Video monitor	Video Input	4-ch composite video input: (NTSC/PAL) BNC (1.0VBP- P, B75Ω)	8-ch composite video input: (NTSC/PAL) BNC (1.0VBP- P, B75Ω)	
	Video Output	1-ch PAL/NTSC, BNC (1.0VP- P, 75Ω) composite video signal output. 1-ch VGA output. 1-ch HDMI output. Support TV/VGA/HDMI video output at the same time.		
	Video Standard	1080P25, 1080P30, 720P/25, 720P/30, 720P/50, 720P/60		
	Record Speed	Real-time Mode: PAL 1f/s to 25f/s per channel and NTSC 1f/s to 30f/s per channel		
	Video Partition	1/4 windows(Optional)	1/4/8/9 windows	
	Monitor Touring	Support monitor tour functions such as alarm, motion detection, and schedule auto control.		
	Resolution (PAL/NTSC)	Real-time monitor: 1080P 1920*1080 Playback: 1/16-ch: 1080P 1920*1080, 720P 1280x720, D1 704x576/704x480, HD1 352x576/352x480, 2CIF 704x288/704x240, CIF 352x288/ 352x240, QCIF 176x144/176x120		

		Support dual streams: extra stream resolution D1 704x576/704x480 CIF 352x288/ 352x240, QCIF 176x144/176x120
	Image Quality	6-level image quality (Adjustable)
	Privacy mask	Support one privacy mask of user-defined size in full screen. Support max 4 zones.
	Image Information	Channel information, time information and privacy mask zone.
	TV Adjust	Adjust TV output zone suitable to anamorphic video.
	Channel Lock	Cover secret channel with blue screen though system is encoding normally. Screen-lock function to prevent unauthorized user seeing secret video.
	Channel Information	Channel name, recording status, screen lock status, video loss status and motion detection status are shown on the bottom left of display screen.
	Color Configuration	Hue, brightness, contrast, saturation and gain setup for each channel.
Audio	Audio Input	4-ch 200-2000mv 10KΩ(BNC)
	Audio Output	1-ch audio output 200-3000mv 5KΩ(BNC)
	Bidirectional Audio	Reuse the AUDIO IN of the first channel and AUDIO OUT.
Hard disk	Hard Disk	4 built-in SATA port. Support 4 HDDs.
	One HDD Capacity	Max 4T
	Hard Disk Occupation	Audio: PCM 28.8MByte/h Video: 56-900MByte/h
Record and playback	Recording Mode	Manual recording, motion detection recording, schedule recording and alarm recording Priority: Manual recording> alarm recording>motion detection recording>schedule recording.
	Storage Mode	Support channel record quota setup
	Recording Length	1 to 120 minutes single record duration (Default setup is 60 minutes)
	Playback Repeat Way	When hard disk is full, system can overwrite previous video file.
	Record Search	Various search engines such as time, type and channel.
	Playback Mode	Various fast play, slow play speeds, manual frame by frame playback and reverse play mode.

	Various File Switch Ways	Can switch to previous or next file or any file in current play list. Can switch to file on other channel of the same time. (If there is a file) Support file continuous play, when file is end system auto plays the next file in the current channel	
	Playback Way	Support mark playback	
	Multi-channel Playback	Support 1/4-channel modes	Support 1/4/8-channel modes
	Window Zoom	Switch between self-adaptive screen/full screen when playback	
	Partial Enlargement	When in one-window full-screen playback mode, you can select any zone to activate partial enlargement function.	
Backup function	Backup Mode	HDD backup	
		Support peripheral USB backup device. (Flash disk, portable disk, USB burner and etc.)	
		Support external eSATA device backup	
		Support network download and backup	
Network Function	Network control	View monitor channel remotely.	
		DVR configuration through client-end and web browser	
		Upgrade via client or browser to realize remote maintenance.	
		View alarm information such as external alarm, motion detection and video loss via client.	
		Support network PTZ lens control	
		File download backup and playback	
		Multiple devices share information via corresponding software such as professional surveillance software (PSS)	
		Duplex transparent COM	
		Network alarm input and output	
		Zero-channel encoding	
Bidirectional audio.			
Motion Detection and Alarm	Motion Detection	Zone setup: support 396((PAL 22x18, NTSC 22x15)) detection zones. Various sensitivity levels. Alarm can activate record or external alarm or screen message prompt.	
	Video Loss	Alarm can activate external alarm or screen message prompt.	
	External Alarm	Support record activation function or activate external alarm or screen message in specified period.	
	Manual Alarm Control	Enable or disable alarm input channel Simulate alarm signal to specific alarm output channel.	
	Alarm Input	4-ch alarm input (NO/NC)	8-ch alarm input (NO/NC)
	Alarm Output	6-channel relay output. (Including one controllable DC 12V output)	
	Alarm Relay	30VDC 2A, 125VAC 1A (activation alarm)	
	USB Interface	3 USB 2.0 ports.	

Interface	Network connection	1 RJ45 10M/100M/1000M self-adaptable Ethernet port
	RS485	1 RS485 port. PTZ control port Support various PTZ control protocols.
	RS232	1 RS232 port. Ordinary COM (Debug), keyboard connection and transparent serial port(COM input and output via network)
	RS422	1 RS422 port.
System Information	Hard Disk Information	Display HDD current status
	Data Stream Statistics	Data stream statistics for each channel (in wave mode)
	Log statistics	Backup to 1024 log files. Support various search engines such as time and type.
	Version	Display version information: channel amount, alarm input and output amount, system version and release date.
	On-line user	Display current on-line user
User Management	User Management	Multi-lever user management; various management modes Integrated management for local user, serial port user and network user. Configurable user power.
		Support user /group and its corresponding rights modification. No limit to the user or group amount.
	Password Authentication	Password modification Administrator can modify other user's password.
		Account lock strategy Five times login failure in thirty minutes may result in account lock.
Upgrade		Web browser, client-end and update tool.
Login, Logout and Shutdown		Password login protection to guarantee safety
		User-friendly interface when login. Provide the following options: Logout /shutdown/ restart.
		Right authentication when shut down to make sure only those proper people can turn off DVR
General Parameter	Power	AC90~264V 50+2% Hz (Max 75W power)
	Power Consumption	≤40W (With adapter, exclude HDD)
	Working Temperature	-10℃— +55℃
	Working Humidity	10%—90%
	Air Pressure	86kpa— 106kpa
	Dimension	1.5U standard industrial case. 440(W) x410(D) x70(H)mm
	Weight	4.5—5.5KG (Exclude HDD)

	Installation Mode	Desktop/Rack installation
--	-------------------	---------------------------

1.3.7 HCVR Advanced 1080P 2U Series

	Parameter	4-ch	8-ch	
System	Main Processor	High-performance industrial embedded micro controller		
	OS	Embedded LINUX		
	System Resources	Multiplex operations: Multiple-channel record, multiple-channel playback and network operation simultaneously		
	Interface	User-friendly graphical user interface		
	Input Devices	USB mouse		
	Input Method	Arabic number, English character, donation and extension Chinese (optional)		
	Shortcut Function	Copy/paste operation, USB mouse right-key shortcut menu, double click USB mouse to switch screen.		
Compression Standard	Video Compression	H.264		
	Audio Compression	G711A, G711U, PCM		
Video monitor	Video Input	4-ch composite video input: (NTSC/PAL) BNC (1.0VBP- P, B75Ω)	8-ch composite video input: (NTSC/PAL) BNC (1.0VBP- P, B75Ω)	
	Video Output	1-ch PAL/NTSC, BNC (1.0VP- P, 75Ω) composite video signal output. 1-ch VGA output. 1-ch HDMI output. Support TV/VGA/HDMI video output at the same time.		
	Video Standard	1080P25, 1080P30, 720P/25, 720P/30, 720P/50, 720P/60		
	Record Speed	Real-time Mode: PAL 1f/s to 25f/s per channel and NTSC 1f/s to 30f/s per channel		
	Video Partition	1/4/8/9 windows(Optional)	1/4/8/9 windows	
	Monitor Touring	Support monitor tour functions such as alarm, motion detection, and schedule auto control.		
	Resolution (PAL/NTSC)	Real-time monitor: 1080P 1920*1080 Playback: 1/16-ch: 1080P 1920*1080, 720P 1280x720, D1 704x576/704x480, HD1 352x576/352x480, 2CIF 704x288/704x240, CIF 352x288/ 352x240, QCIF 176x144/176x120		

		Support dual streams: extra stream resolution D1 704x576/704x480 CIF 352x288/ 352x240, QCIF 176x144/176x120
	Image Quality	6-level image quality (Adjustable)
	Privacy mask	Support one privacy mask of user-defined size in full screen. Support max 4 zones.
	Image Information	Channel information, time information and privacy mask zone.
	TV Adjust	Adjust TV output zone suitable to anamorphic video.
	Channel Lock	Cover secret channel with blue screen though system is encoding normally. Screen-lock function to prevent unauthorized user seeing secret video.
	Channel Information	Channel name, recording status, screen lock status, video loss status and motion detection status are shown on the bottom left of display screen.
	Color Configuration	Hue, brightness, contrast, saturation and gain setup for each channel.
Audio	Audio Input	4-ch 200-2000mv 10KΩ(BNC) 8-ch 200-2000mv 10KΩ(BNC)
	Audio Output	1-ch audio output 200-3000mv 5KΩ(BNC)
	Bidirectional Audio	Reuse the AUDIO IN of the first channel and AUDIO OUT.
Hard disk	Hard Disk	8 built-in SATA port. Support 8 HDDs.
	One HDD Capacity	Max 4T
	Hard Disk Occupation	Audio: PCM 28.8MByte/h Video: 56-900MByte/h
Record and playback	Recording Mode	Manual recording, motion detection recording, schedule recording and alarm recording Priority: Manual recording> alarm recording>motion detection recording>schedule recording.
	Storage Mode	Support channel record quota setup
	Recording Length	1 to 120 minutes single record duration (Default setup is 60 minutes)
	Playback Repeat Way	When hard disk is full, system can overwrite previous video file.
	Record Search	Various search engines such as time, type and channel.
	Playback Mode	Various fast play, slow play speeds, manual frame by frame playback and reverse play mode.

	Various File Switch Ways	Can switch to previous or next file or any file in current play list. Can switch to file on other channel of the same time. (If there is a file) Support file continuous play, when file is end system auto plays the next file in the current channel	
	Playback Way	Support mark playback	
	Multi-channel Playback	Support 1/4-channel modes	Support 1/4/8-channel modes
	Window Zoom	Switch between self-adaptive screen/full screen when playback	
	Partial Enlargement	When in one-window full-screen playback mode, you can select any zone to activate partial enlargement function.	
Backup function	Backup Mode	HDD backup	
		Support peripheral USB backup device. (Flash disk, portable disk, USB burner and etc.)	
		Support external eSATA device backup	
		Support network download and backup	
Network Function	Network control	View monitor channel remotely.	
		DVR configuration through client-end and web browser	
		Upgrade via client or browser to realize remote maintenance.	
		View alarm information such as external alarm, motion detection and video loss via client.	
		Support network PTZ lens control	
		File download backup and playback	
		Multiple devices share information via corresponding software such as professional surveillance software (PSS)	
		Duplex transparent COM	
		Network alarm input and output	
		Zero-channel encoding	
Bidirectional audio.			
Motion Detection and Alarm	Motion Detection	Zone setup: support 396((PAL 22×18, NTSC 22×15)) detection zones. Various sensitivity levels. Alarm can activate record or external alarm or screen message prompt.	
	Video Loss	Alarm can activate external alarm or screen message prompt.	
	External Alarm	Support record activation function or activate external alarm or screen message in specified period.	
	Manual Alarm Control	Enable or disable alarm input channel Simulate alarm signal to specific alarm output channel.	
	Alarm Input	4-ch alarm input (NO/NC)	8-ch alarm input (NO/NC)
	Alarm Output	6-channel relay output. (Including one controllable DC 12V output)	
	Alarm Relay	30VDC 2A, 125VAC 1A (activation alarm)	
	USB Interface	4 USB 2.0 ports.	

Interface	Network connection	Two RJ45 10M/100M/1000M self-adaptable Ethernet ports
	RS485	1 RS485 port. PTZ control port Support various PTZ control protocols.
	RS232	1 RS232 port. Ordinary COM (Debug), keyboard connection and transparent serial port(COM input and output via network)
	RS422	1 RS422 Port
System Information	Hard Disk Information	Display HDD current status
	Data Stream Statistics	Data stream statistics for each channel (in wave mode)
	Log statistics	Backup to 1024 log files. Support various search engines such as time and type.
	Version	Display version information: channel amount, alarm input and output amount, system version and release date.
	On-line user	Display current on-line user
User Management	User Management	Multi-lever user management; various management modes Integrated management for local user, serial port user and network user. Configurable user power.
		Support user /group and its corresponding rights modification. No limit to the user or group amount.
	Password Authentication	Password modification Administrator can modify other user's password.
		Account lock strategy Five times login failure in thirty minutes may result in account lock.
Upgrade		Web browser, client-end and update tool.
Login, Logout and Shutdown		Password login protection to guarantee safety
		User-friendly interface when login. Provide the following options: Logout /shutdown/ restart.
		Right authentication when shut down to make sure only those proper people can turn off DVR
General Parameter	Power	AC90~264V 50+2% Hz (Max 220W power)
	Power Consumption	≤60W (With adapter, exclude HDD)
	Working Temperature	-10℃ — +55℃
	Working Humidity	10%—90%
	Air Pressure	86kpa— 106kpa
	Dimension	2U standard industrial case. 440(W) x460(D) x89(H)mm

	Weight	7.0—8.0KG (Exclude HDD)
	Installation Mode	Desktop/Rack installation

2 Overview and Controls

This section provides information about front panel and rear panel. When you install this series DVR for the first time, please refer to this part first.

2.1 Front Panel

2.1.1 1U Series

The front panel is shown as below. See Figure 2-1.

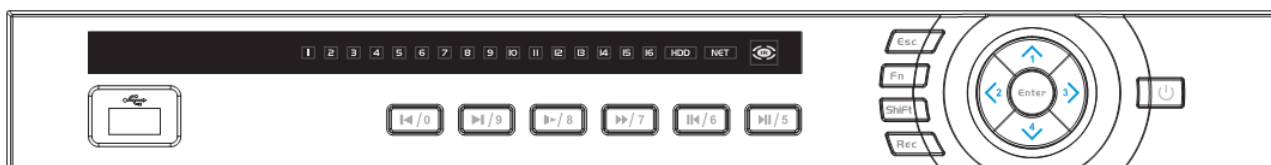









Figure 2-1

Please refer to the following sheet for front panel button information.

Name	Icon	Function
Power button		Power button, press this button for three seconds to boot up or shut down DVR.
Shift	Shift	In textbox, click this button to switch between numeral, English(Small/Capitalized),donation and etc.
Up/1Down/4		Activate current control, modify setup, and then move up and down.
		Increase/decrease numeral.
		Assistant function such as PTZ menu.
Left/2 Right/3		Shift current activated control,
		When playback, click these buttons to control playback bar. In text mode, input number 2(English character A/B/C) /3(English character D/E/F)
ESC	ESC	Go to previous menu, or cancel current operation.
		When playback, click it to restore real-time monitor mode.
Enter	ENTER	Confirm current operation
		Go to default button
		Go to menu
Record	REC	Manually stop/start recording, working with direction keys or numeral keys to select the recording channel.

Slow play/8		Multiple slow play speeds or normal playback. In text mode, input number 8 (English character T/U/V).
Assistant	Fn	One-window monitor mode, click this button to display assistant function: PTZ control and image color.
		Backspace function: in numeral control or text control, press it for 1.5seconds to delete the previous character before the cursor.
		In motion detection setup, working with Fn and direction keys to realize setup.
		In text mode, click it to switch between numeral, English character(small/capitalized) and etc.
		Realize other special functions.
Fast play/7		Various fast speeds and normal playback. In text mode, input number 7 (English character P/Q/R/S).
Play previous/0		In playback mode, playback the previous video In text mode, input number 0.
Reverse/Pause/6		In normal playback or pause mode, click this button to reverse playback In reverse playback, click this button to pause playback.
Play Next/9		In playback mode, playback the next video In menu setup, go to down ward of the dropdown list. In text mode, input number 9 (English character W/X/Y/Z)
Play/Pause /5		In normal playback click this button to pause playback In pause mode, click this button to resume playback. In text mode, input number 5(English character J/K/L).
USB port		To connect USB storage device, USB mouse.
Network abnormal indication light	Net	Network error occurs or there is no network connection, the light becomes red to alert you.
HDD abnormal indication light	HDD	HDD error occurs or HDD capacity is below specified threshold value, the light becomes red to alert you.
Record light	1-16	System is recording or not. It becomes on when system is recording.
IR Receiver	IR	It is to receive the signal from the remote control.

2.1.2 1.5U Series

The front panel is shown as in Figure 2-2.

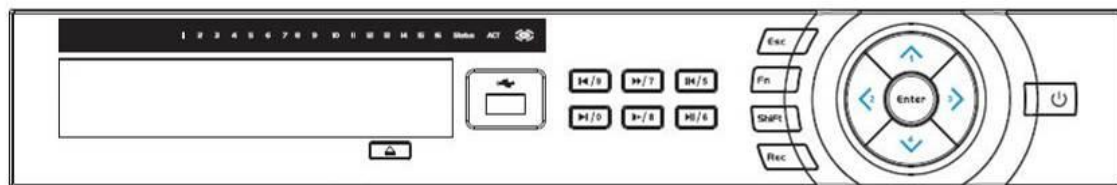



Figure 2-2

Please refer to the following sheet for front panel button information.

Name	Icon	Function
Power button		Power button, press this button for three seconds to boot up or shut down DVR.
Shift	Shift	In textbox, click this button to switch between numeral, English(Small/Capitalized),donation and etc.
Up/1 Down/4		Activate current control, modify setup, and then move up and down.
		Increase/decrease numeral.
		Assistant function such as PTZ menu.
		In text mode, input number 1/4 (English character G/H/I)
Left/2 Right/3		Shift current activated control,
		When playback, click these buttons to control playback bar. In text mode, input number 2(English character A/B/C) 3(English character D/E/F)
ESC	ESC	Go to previous menu, or cancel current operation.
		When playback, click it to restore real-time monitor mode.
Enter	ENTER	Confirm current operation
		Go to default button
		Go to menu
Record	REC	Manually stop/start recording, working with direction keys or numeral keys to select the recording channel.
Slow play/8		Multiple slow play speeds or normal playback. In text mode, input number 8 (English character T/U/V).
Assistant	Fn	One-window monitor mode, click this button to display assistant function: PTZ control and image color.

		<p>Backspace function: in numeral control or text control, press it for 1.5seconds to delete the previous character before the cursor.</p> <p>In motion detection setup, working with Fn and direction keys to realize setup.</p> <p>In text mode, click it to switch between numeral, English character(small/capitalized) and etc.</p> <p>Realize other special functions.</p>
Fast play/7	▶▶	<p>Various fast speeds and normal playback.</p> <p>In text mode, input number 7 (English character P/Q/R/S).</p>
Play previous/0	◀	<p>In playback mode, playback the previous video</p> <p>In text mode, input number 0.</p>
Reverse/Pause/6	◀	<p>In normal playback or pause mode, click this button to reverse playback</p> <p>In reverse playback, click this button to pause playback.</p>
Play Next/9	▶	<p>In playback mode, playback the next video</p> <p>In menu setup, go to down ward of the dropdown list.</p> <p>In text mode, input number 9 (English character W/X/Y/Z)</p>
Play/Pause /5	▶	<p>In normal playback click this button to pause playback</p> <p>In pause mode, click this button to resume playback.</p> <p>In text mode, input number 5(English character J/K/L).</p>
USB port		To connect USB storage device, USB mouse.
Network abnormal indication light	Net	Network error occurs or there is no network connection, the light becomes red to alert you.
HDD abnormal indication light	HDD	HDD error occurs or HDD capacity is below specified threshold value, the light becomes red to alert you.
Record light	1-16	System is recording or not. It becomes on when system is recording.

2.1.3 2U Series

This series products' front panel is shown as below. See Figure 2-3.

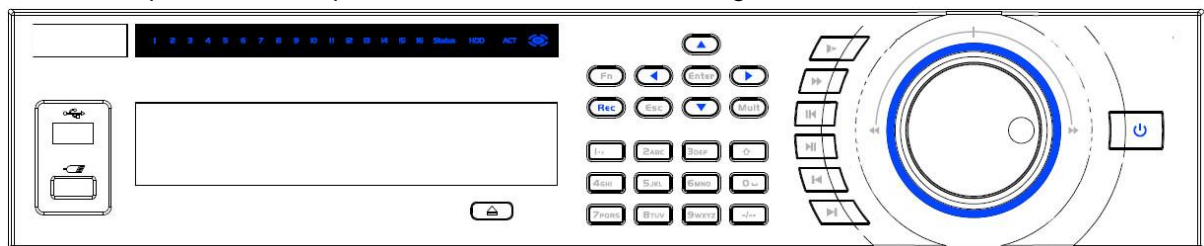













Figure 2-3

Please refer to the following sheet for front panel button information.

Name	Icon	Function
Power button		Power button, press this button for three seconds to boot up or shut down DVR.
Number button	0-9	Input Arabic number Switch channel
Input number more than 10	-/--	If you want to input a number more than 10, please click this button and then input.
Shift		In textbox, click this button to switch between numeral, English(Small/Capitalized),donation and etc.
		Enable or disable tour.
Fast play		Various fast speeds and normal playback.
Slow play		Multiple slow play speeds or normal playback.
Play/Pause		In normal playback click this button to pause playback In pause mode, click this button to resume playback.
Reverse/Pause		In normal playback or pause mode, click this button to reverse playback In reverse playback, click this button to pause playback.
Play previous		In playback mode, playback the previous video
Play Next		In playback mode, playback the next video In menu setup, go to down ward of the dropdown list.
Up/ Down		Activate current control, modify setup, and then move up and down.
		Increase/decrease numeral.
		Assistant function such as PTZ menu.
Left/ Right		Shift current activated control, and then move left and right.
		When playback, click these buttons to control playback bar.
ESC	ESC	Go to previous menu, or cancel current operation.
		When playback, click it to restore real-time monitor mode.
Enter	ENTER	Confirm current operation
		Go to default button
		Go to menu

Assistant	Fn	One-window monitor mode, click this button to display assistant function: PTZ control and image color.
		Backspace function: in numeral control or text control, press it for 1.5 seconds to delete the previous character before the cursor.
		In motion detection setup, working with Fn and direction keys to realize setup.
		In text mode, click it to switch between numeral, English character(small/capitalized) and etc.
		In HDD management interface, you can click it to switch HDD record information and other information (Menu prompt)
		Realize other special functions.
Record	REC	Manually stop/start recording, working with direction keys or numeral keys to select the recording channel.
Window switch	Mult	Click it to switch one-window/multiple-window.
Shuttle(outer ring)		In real-time monitor mode it works as left/right direction key. Playback mode, counter clockwise to forward and clock wise to backward.
Jog(inner dial)		Up/down direction key. Playback mode, turn the inner dial to realized frame by frame playback. (Only applies to some special versions.)
USB port		To connect USB storage device, USB mouse, burner and etc.
Record light	1-32	For 4/8/16 channel device: indication light on means that the channel is in recording.
		For 32 channel device: Indication Light on: 1-16 channel is in recording Indication Light flashes: 17-32 channel is in recording Indication Light normally on: the corresponding channels are in recording
Remote control indication light	ACT	Remote control indication light
Status indication light	Status	The light is on if device operates properly.
Power indication light	PWR	Power indication light
IR Receiver	IR	It is to receive the signal from the remote control.

2.2 Rear Panel

2.2.1 4/8-Channel HCVR General 720P 1U Series and 4-Channel HCVR Advanced 1080P 1U Series

This series products' rear panel is shown as below. See Figure 2-4.

The following figure is based on the 8-channel series product.

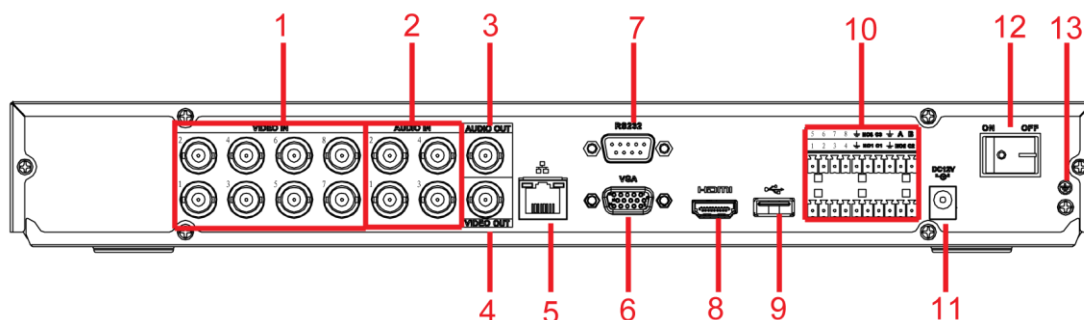







Figure 2-4

Please refer to the following sheet for detailed information.

SN	Icon	Name	Function
1	VIDEO IN	Video input port	Connect to analog camera, video input signal.
2	AUDIO IN	Audio input port	Connect to microphone and etc to input signal.
3	AUDIO OUT	Audio output port	Connect to sound box and etc to output audio signal.
4	VIDEO OUT	Video output port	Connect to output devices such as TV.
5		Network port	100M Ethernet port
6	VGA	VGA video output port	VGA video output port. Output analog video signal. It can connect to the monitor to view analog video.
7	RS-232	RS-232 debug port	It is for general COM debug to configure IP address or transfer transparent COM data.
8	HDMI	High definition media interface	High definition audio and video signal output port. It transmits uncompressed high definition video and multiple-channel data to the HDMI port of the display device.
9		USB2.0 port	Connect to mouse, USB storage media, USB-burner and etc.
10	1-8	Alarm input	● There are two groups. The

		port1~8	<p>first group is from port 1 to port 4, the second group is from port 5 to port 8. They are to receive the signal from the external alarm source. There are two types; NO (normal open)/NC (normal close).</p> <p>When your alarm input device is using external power, please make sure the device and the NVR have the same ground.</p>
	NO1 C1 ~ NO3 C3	Alarm output port 1~3	<ul style="list-style-type: none"> ● 3 groups of alarm output ports. (Group 1: port NO1~C1, Group 2: port NO2 ~C2, Group 3: port NO3 ~C3)).Output alarm signal to the alarm device. Please make sure there is power to the external alarm device. ● NO : Normal open alarm output port. ● C: Alarm output public end.
	A	RS485 (RS-485) communication port	RS485_A port. It is the cable A. You can connect to the control devices such as speed dome PTZ.
	B		RS485_B.It is the cable B. You can connect to the control devices such as speed dome PTZ.
11		Power input port	Input DC 12V
12		Power switch	Power on/off button.
13		GND	Ground port

2.2.2 16-Channel HCVR General 720P 1U Series and 8-Channel HCVR Advanced 1080P 1U Series

This series products' rear panel is shown as below. See Figure 2-5.

The following figure is based on the 16-channel series product.

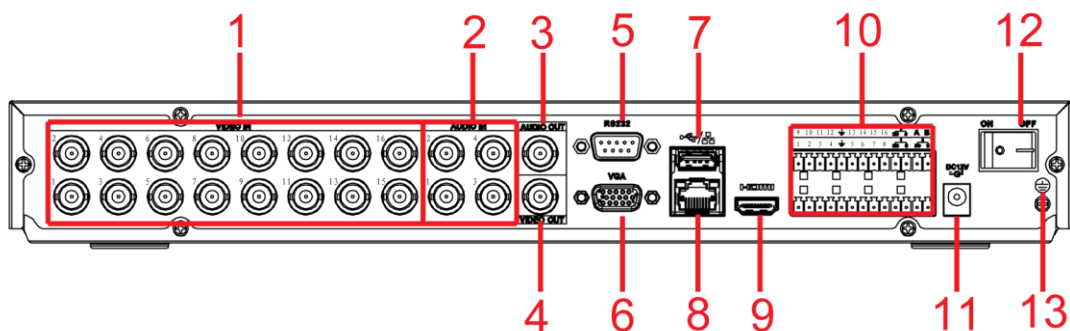







Figure 2-5

Please refer to the following sheet for detailed information.

SN	Icon	Name	Function
1	VIDEO IN	Video input port	Connect to analog camera, video input signal.
2	AUDIO IN	Audio input port	Connect to microphone and etc to input signal.
3	AUDIO OUT	Audio output port	Connect to sound box and etc to output audio signal.
4	VIDEO OUT	Video output port	Connect to output devices such as TV.
5	RS-232	RS-232 debug port	It is for general COM debug to configure IP address or transfer transparent COM data.
6	VGA	VGA video output port	VGA video output port. Output analog video signal. It can connect to the monitor to view analog video.
7		USB2.0 port	Connect to mouse, USB storage media, USB-burner and etc.
8		Network port	100M Ethernet port
9	HDMI	High definition media interface	High definition audio and video signal output port. It transmits uncompressed high definition video and multiple-channel data to the HDMI port of the display device.
10	1~16	Alarm input port1~16	<ul style="list-style-type: none"> There are four groups. The first group is from port 1 to port 4, the second group is from port 5 to port 8, the third group is from port9 to port 12, the fourth group is from port13 to port 16. They

			<p>are to receive the signal from the external alarm source. There are two types; NO (normal open)/NC (normal close).</p> <ul style="list-style-type: none"> ● When your alarm input device is using external power, please make sure the device and the NVR have the same ground.
	NO1 C1 ~ NO3 C3	Alarm output port 1~3	<ul style="list-style-type: none"> ● 3 groups of alarm output ports. (Group 1: port NO1~C1, Group 2: port NO2 ~C2, Group 3: port NO3 ~C3)).Output alarm signal to the alarm device. Please make sure there is power to the external alarm device. ● NO : Normal open alarm output port. ● C: Alarm output public end.
	A	RS485 (RS-485) communication port	RS485_A port. It is the cable A. You can connect to the control devices such as speed dome PTZ.
	B		RS485_B.It is the cable B. You can connect to the control devices such as speed dome PTZ.
11		Power input port	Input DC 12V
12		Power switch	Power on/off button.
13		GND	Ground port

2.2.3 HCVR General 2-HDD 720P 1.5U Series

The 8-channel series products' rear panel is shown as below. See Figure 2-6.

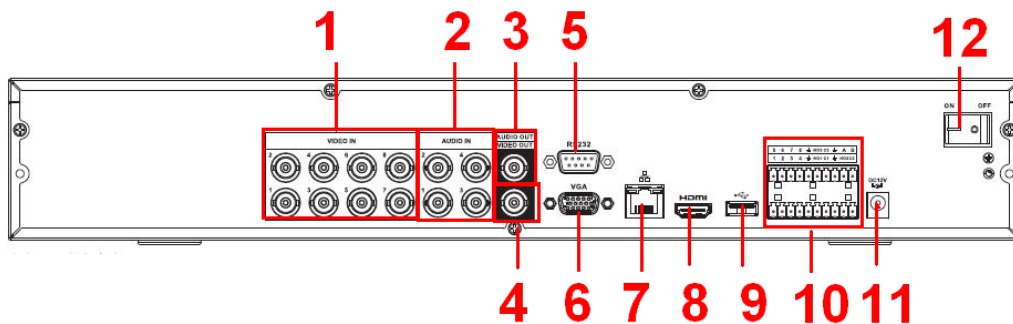

Figure 2-6

The 16-channel series products' rear panel is shown as below. See Figure 2-7.

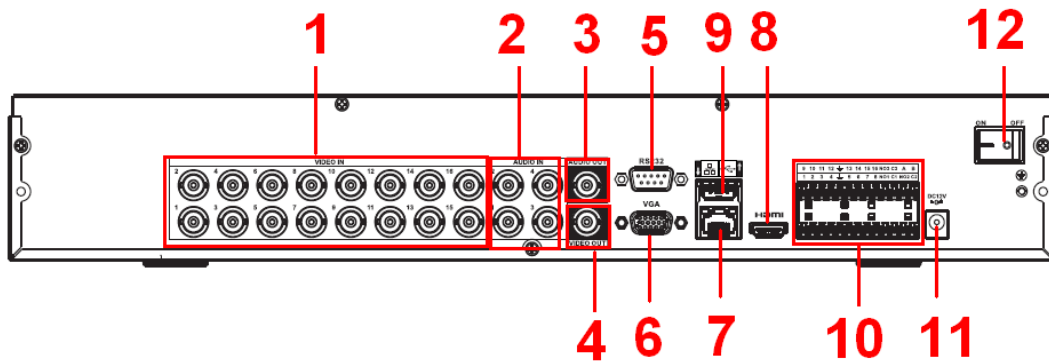

Figure 2-7

Please refer to the following sheet for detailed information.

1	Video input
2	Audio input
3	Audio output
4	Video output
5	RS232 port
6	Video VGA output
7	Network port
8	HDMI output
9	USB port
10	Alarm input/alarm output/RS485 port
11	Power socket
12	Power on-off button

2.2.4 HCVR General 4-HDD 720P 1.5U Series and HCVR Advanced 1080P 1.5U Series

This series products' rear panel is shown as below. See Figure 2-8.

The following figure is based on the 16-channel series product.

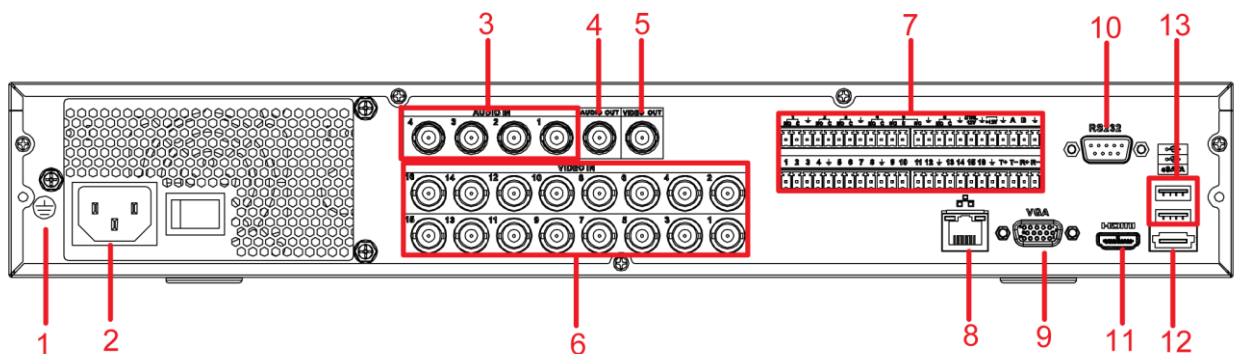





Figure 2-8

Please refer to the following sheet for detailed information.

SN	Icon	Name	Function
1		GND	Ground port
2		Power input port	Power input socket.
3	AUDIO IN	Audio input port	Connect to microphone and etc to input signal.
4	AUDIO OUT	Audio output port	Connect to sound box and etc to output audio signal.
5	VIDEO OUT	Video output port	Connect to output devices such as TV.
6	VIDEO IN	Video input port	Connect to analog camera, video input signal.
7	1~16	Alarm input port 1~16	<ul style="list-style-type: none"> There are four groups. The first group is from port 1 to port 4, the second group is from port 5 to port 8, the third group is from 9 to 12, and the fourth group is from 13 to 16. They are to receive the signal from the external alarm source. There are two types; NO (normal open)/NC (normal close). When your alarm input device is using external power, please make sure the device and the NVR have the same ground.
	NO1~NO6	Alarm output port 1~6	<ul style="list-style-type: none"> 5 groups of alarm output ports. (Group 1: port NO1~C1, Group 2: port NO2~C2, Group 3: port NO3~C3, Group 4: port NO4~C4, Group 5: port NO5, C5, NC5, Group 6: port NO6, C6, NC6). Output alarm signal to the alarm device. Please make sure there is power to the external alarm device. NO: Normal open alarm output port. C: Alarm output public end. NC: Normal close alarm output port.
	C1~C6		
	NC5		
A	RS485 (RS-485) communication port	RS485_A port. It is the cable A. You can connect to the control devices such as speed dome PTZ.	

	B		RS485_B.It is the cable B. You can connect to the control devices such as speed dome PTZ.
	T+,T-, R+, R-	Four-cable full-duplex 485 port	Four-cable 485 port. T+ and T- is the output cable and R- is the receive cable.
	CTRL 12V	Control power output	Turn off power output
8		Network port	100M Ethernet port
9	VGA	VGA video output port	VGA video output port. Output analog video signal. It can connect to the monitor to view analog video.
10	RS-232	RS-232 debug port	It is for general COM debug to configure IP address or transfer transparent COM data.
11	HDMI	High definition media interface	High definition audio and video signal output port. It transmits uncompressed high definition video and multiple-channel data to the HDMI port of the display device.
12	eSATA	eSATA port	External SATA port. It can connect to the device of the SATA port. Please jump the HDD when there is peripheral connected HDD.
13		USB2.0 port	Connect to mouse, USB storage media, USB-burner and etc.

2.2.5 HCVR General 4-HDD 720P 2U Series and HCVR Advanced 1080P 2U Series

The rear panel is shown as in Figure 2-9.

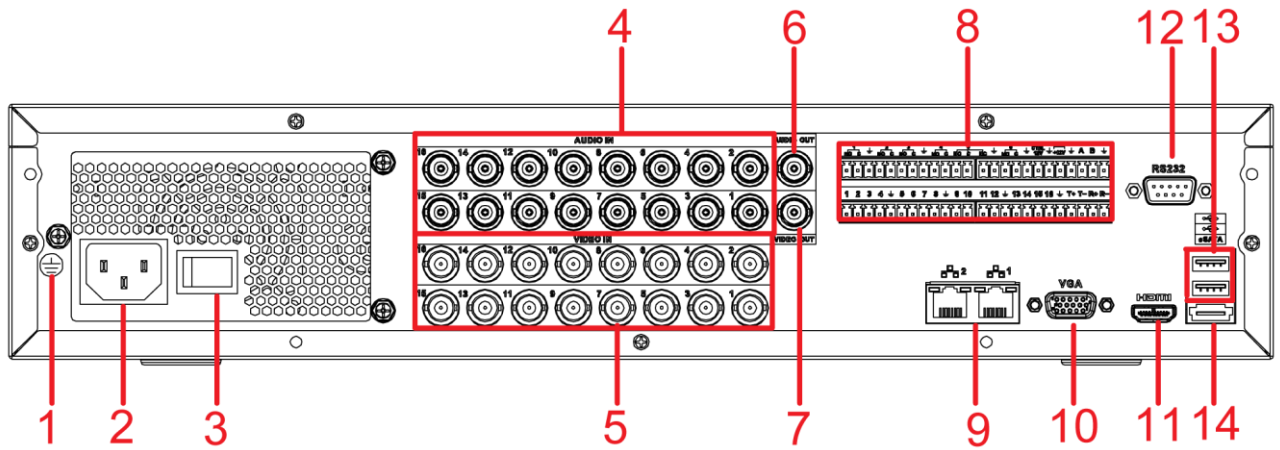



Figure 2-9

Please refer to the following sheet for detailed information.

SN	Icon	Name	Function
1		GND	Ground port
2		Power input port	Power socket.
3		Power switch	Power on/off button.
4	AUDIO IN	Audio input port	Connect to microphone and etc to input signal.
5	VIDEO IN	Video input port	Connect to analog camera, video input signal.
6	AUDIO OUT	Audio output port	Connect to sound box and etc to output audio signal.
7	VIDEO OUT	Video output port	Connect to output devices such as TV.
8	1~16	Alarm input port 1~16	<ul style="list-style-type: none"> There are four groups. The first group is from port 1 to port 4, the second group is from port 5 to port 8, the third group is from 9 to 12, and the fourth group is from 13 to 16. They are to receive the signal from the external alarm source. There are two types; NO (normal open)/NC (normal close). When your alarm input device is using external power, please make sure the device and the NVR have the same ground.
	NO1~NO6	Alarm output port	<ul style="list-style-type: none"> 5 groups of alarm output ports. (Group 1: port NO1~

	C1~C6	1~6	C1,Group 2:port NO2 ~ C2,Group 3:port NO3 ~ C3, Group 4: port NO4~C4, Group 5: port NO5, C5, NC5, Group 6: port NO6, C6, NC6).Output alarm signal to the alarm device. Please make sure there is power to the external alarm device. ● NO: Normal open alarm output port. ● C: Alarm output public end. ● NC: Normal close alarm output port.
	NC5		
	A	RS485 (RS-485) communication port	RS485_A port. It is the cable A. You can connect to the control devices such as speed dome PTZ.
	B		RS485_B.It is the cable B. You can connect to the control devices such as speed dome PTZ.
9		Network port	100M Ethernet port
10	VGA	VGA video output port	VGA video output port. Output analog video signal. It can connect to the monitor to view analog video.
11	HDMI	High definition media interface	High definition audio and video signal output port. It transmits uncompressed high definition video and multiple-channel data to the HDMI port of the display device.
12	RS-232	RS-232 debug port	It is for general COM debug to configure IP address or transfer transparent COM data.
13		USB2.0 port	Connect to mouse, USB storage media, USB-burner and etc.
14	eSATA	eSATA port	External SATA port. It can connect to the device of the SATA port. Please jump the HDD when there is peripheral connected HDD.

When connect the Ethernet port, please use crossover cable to connect the PC and use the straight cable to connect to the switch or router.

2.3 Connection Sample

2.3.1 4/8-Channel HCVR General 720P 1U Series and 4-Channel HCVR Advanced 1080P 1U Series

Please refer to the following figure for detailed information. See Figure 2-10.

The following interface is based on the 8-channel series product.

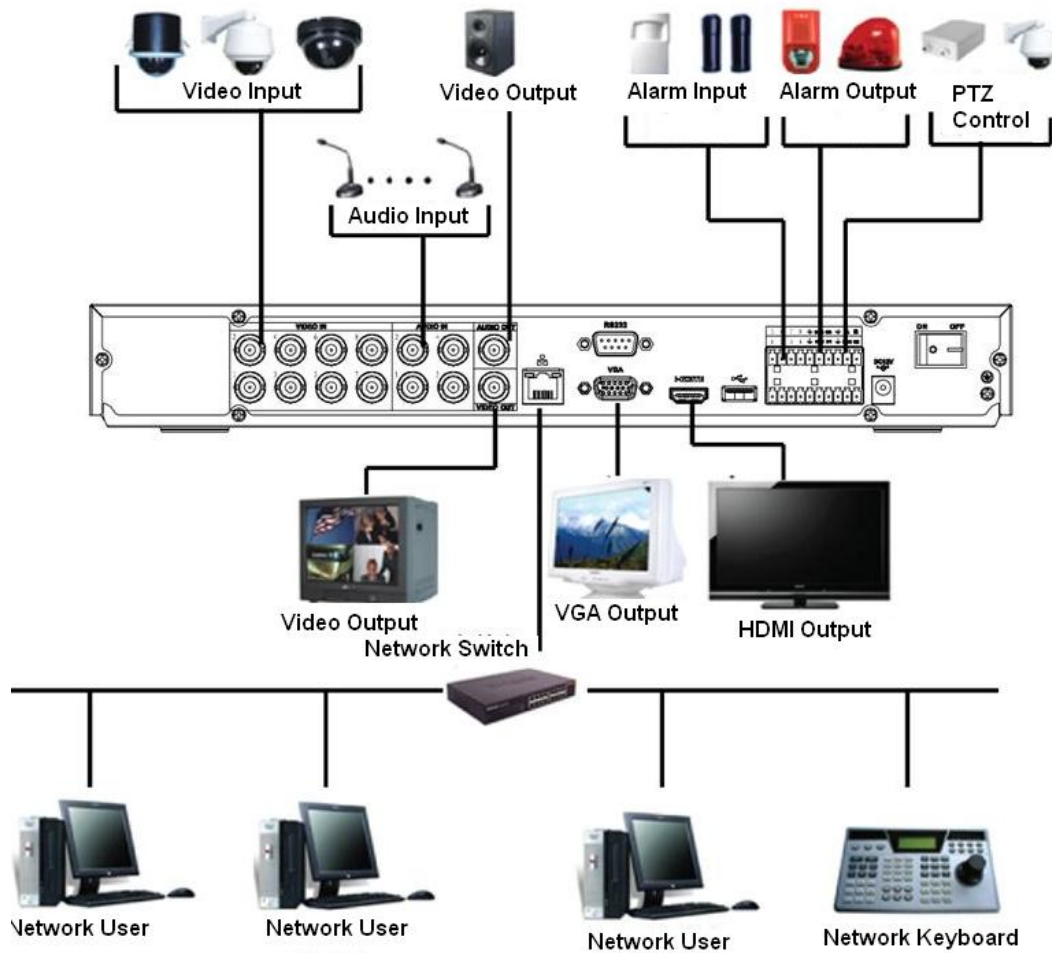

Figure 2-10

2.3.2 16-Channel HCVR General 720P 1U Series and 8-Channel HCVR Advanced 1080P 1U Series

Please refer to the following figure for detailed information. See Figure 2-11.

The following interface is based on the 16-channel general 720P 1U series product.

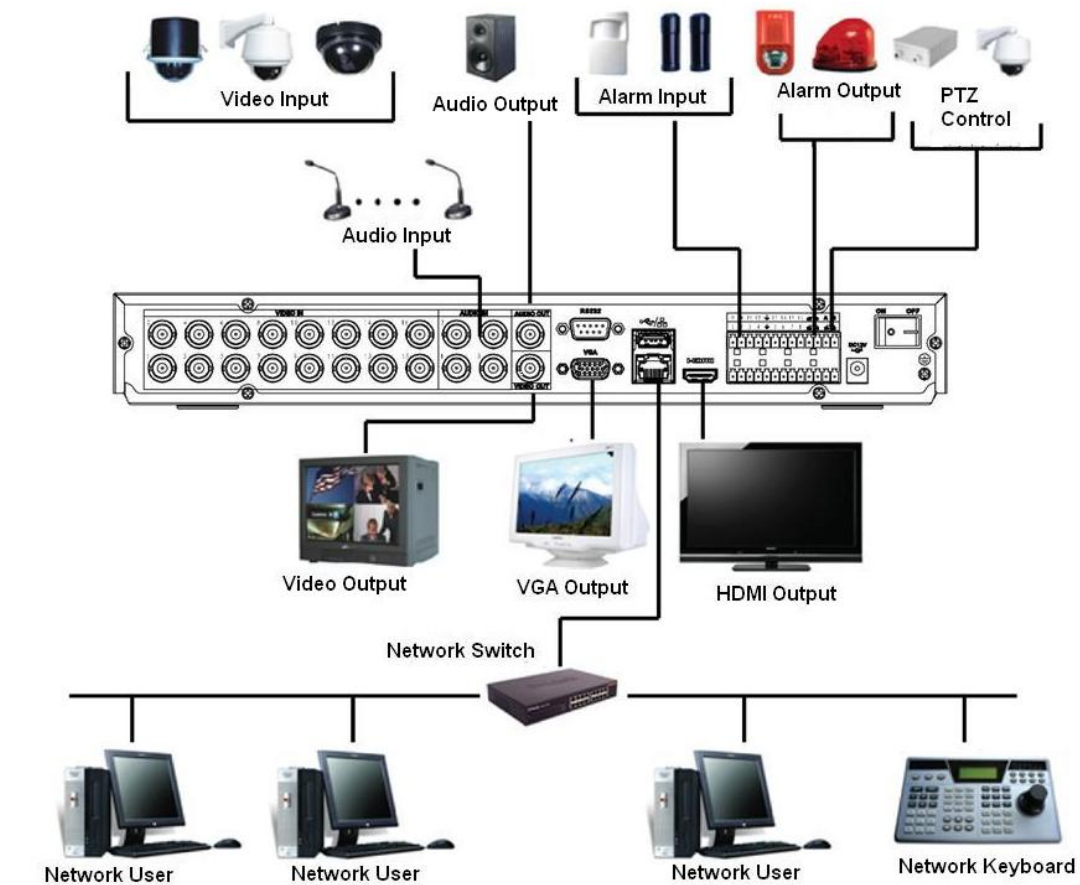

Figure 2-11

2.3.3 HCVR General 2-HDD 720P 1.5U Series/HCVR General 4-HDD 720P 1.5U Series /HCVR Advanced 1080P 1.5U Series

Please refer to the following figure for detailed information. See Figure 2-12.

The following interface is based on the 16-channel HCVR general 720P 1.5U series product.

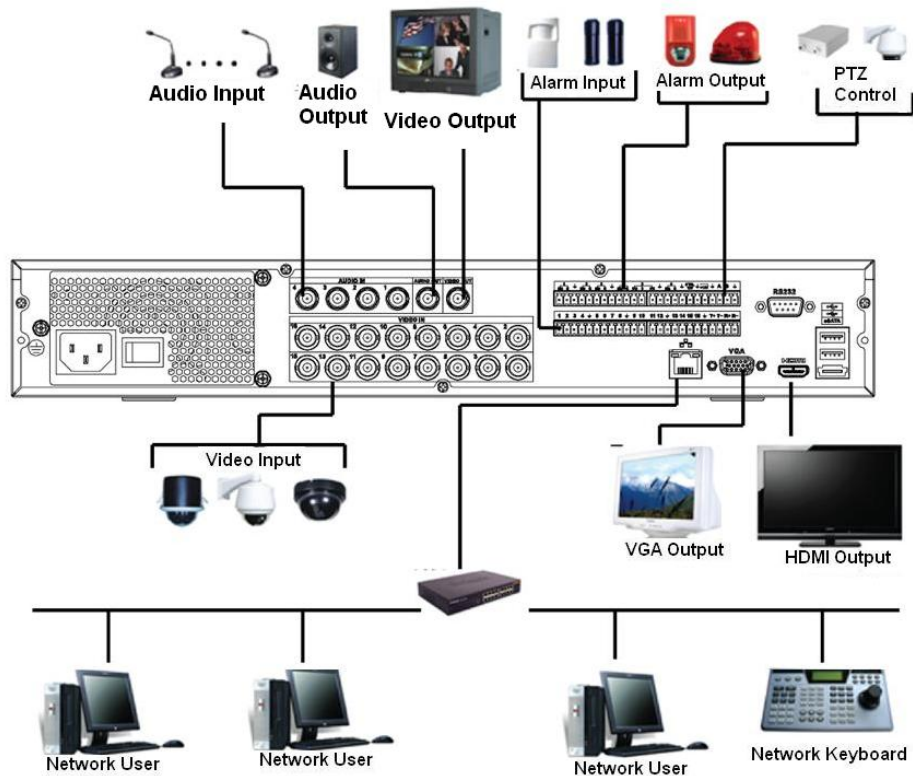

Figure 2-12

2.3.4 HCVR General 720P 2U Series and HCVR Advanced 1080P 2U Series

Please refer to the following figure for detailed information. See Figure 2-13. The following interface is based on the 16-channel 720P 2U series product.

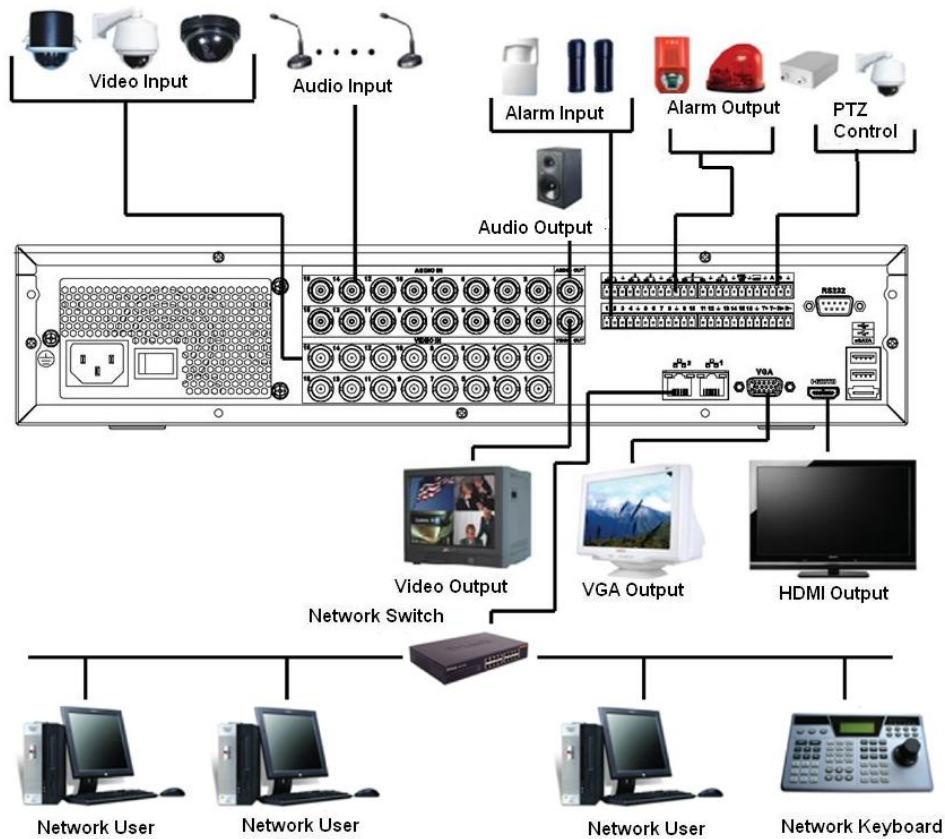

Figure 2-13

2.4 Remote Control

The remote control interface is shown as in Figure 2-14.

Please note remote control is not our standard accessory and it is not included in the accessory bag.

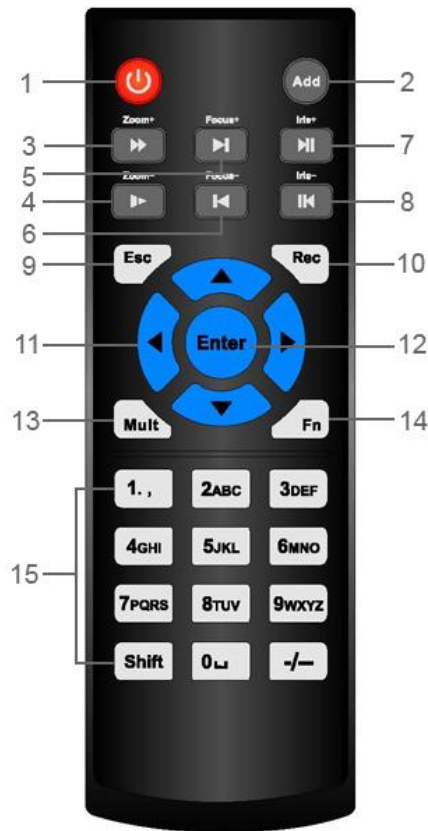



Figure 2-14

Serial Number	Name	Function
1	Power button	Click it to boot up or shut down the device.
2	Address	Click it to input device number, so that you can control it.
3	Forward	Various forward speeds and normal speed playback.
4	Slow play	Multiple slow play speeds or normal playback.
5	Next record	In playback mode, playback the next video.
6	Previous record	In playback mode, playback the previous video.
7	Play/Pause	In pause mode, click this button to realize normal playback. In normal playback click this button to pause playback. In real-time monitor mode, click this button to enter video search menu.
	Reverse/pause	Reverse playback pause mode,

8		click this button to realize normal playback.
		In reverse playback click this button to pause playback.
9	Esc.	Go back to previous menu or cancel current operation (close upper interface or control)
10	Record	Start or stop record manually In record interface, working with the direction buttons to select the record channel. Click this button for at least 1.5 seconds, system can go to the Manual Record interface.
11	Direction keys	Switch current activated control, go to left or right. In playback mode, it is to control the playback process bar. Aux function(such as switch the PTZ menu)
12	Enter /menu key	go to default button go to the menu
13	Multiple-window switch	Switch between multiple-window and one-window.
14	Fn	In 1-ch monitor mode: pop up assistant function: PTZ control and Video color.
		Switch the PTZ control menu in PTZ control interface.
		In motion detection interface, working with direction keys to complete setup.
		In text mode, click it to delete character.
15	0-9 number key	Input password, channel or switch channel.
		Shift is the button to switch the input method.

2.5 Mouse Control

Left click mouse	System pops up password input dialogue box if you have not logged in. In real-time monitor mode, you can go to the main menu.
------------------	--

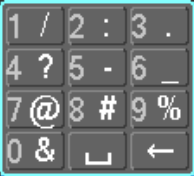
	<p>When you have selected one menu item, left click mouse to view menu content.</p> <p>Implement the control operation.</p> <p>Modify checkbox or motion detection status.</p> <p>Click combo box to pop up drop down list</p> <p>In input box, you can select input methods. Left click the corresponding button on the panel you can input numeral/English character (small/capitalized). Here ← stands for backspace button. _ stands for space button.</p> <p>In English input mode: _stands for input a backspace icon and ← stands for deleting the previous character.</p> <div style="display: flex; justify-content: space-around; align-items: center;">   </div> <p>In numeral input mode: _ stands for clear and ← stands for deleting the previous numeral.</p> <p>When input special sign, you can click corresponding numeral in the front panel to input. For example, click numeral 1 you can input"/" , or you can click the numeral in the on-screen keyboard directly.</p> <div style="text-align: center;">  </div>
<p>Double left click mouse</p>	<p>Implement special control operation such as double click one item in the file list to playback the video.</p> <p>In multiple-window mode, double left click one channel to view in full-window.</p> <p>Double left click current video again to go back to previous multiple-window mode.</p>

Right click mouse	<p>In real-time monitor mode, pops up shortcut menu: one-window, four-window, nine-window and sixteen-window, Pan/Tilt/Zoom, color setting, search, record, alarm input, alarm output, main menu. Among which, Pan/Tilt/Zoom and color setting applies for current selected channel.</p> <p>If you are in multiple-window mode, system automatically switches to the corresponding channel.</p> 
	Exit current menu without saving the modification.
Press middle button	<p>In numeral input box: Increase or decrease numeral value.</p> <p>Switch the items in the check box.</p> <p>Page up or page down</p>
Move mouse	Select current control or move control
Drag mouse	<p>Select motion detection zone</p> <p>Select privacy mask zone.</p>

2.6 Virtual Keyboard & Front Panel

2.6.1 Virtual Keyboard

The system supports two input methods: numeral input and English character (small and capitalized) input.

Move the cursor to the text column, the text is shown as blue, input button pops up on the right. Click that button to switch between numeral input and English input (capitalized and small), Use > or < to shift between small character and capitalized character.

2.6.2 Front Panel

Move the cursor to the text column. Click Fn key and use direction keys to select number you wanted. Please click enter button to input.

3 Installation and Connections

Note: All the installation and operations here should conform to your local electric safety rules.

3.1 Check Unpacked DVR

When you receive the DVR from the forwarding agent, please check whether there is any visible damage. The protective materials used for the package of the DVR can protect most accidental clashes during transportation. Then you can open the box to check the accessories.

Please check the items in accordance with the list. Finally you can remove the protective film of the DVR.

Note

Remote control is not a standard accessory and it is not included in the accessory bag.

3.2 About Front Panel and Rear Panel

The model in the front panel is very important; please check according to your purchase order.

The label in the rear panel is very important too. Usually we need you to represent the serial number when we provide the service after sales.

3.2.1 HDD Installation

This series DVR has 1 to 8 HDDs (no limitation for capacity). Please use HDD of 7200rpm or higher. Usually we do not recommend the HDD for the PC. You can refer to the Appendix for recommended HDD brand.

All figures listed here are for reference only.

Please follow the instructions listed below to install hard disk.

3.2.2 1U Series

The mini 1U series DVR has one SATA HDD and 1U series DVR has two SATA HDDs.



1. Loosen the screws of the upper cover and side panel.	2. Fix four screws in the HDD (Turn just three rounds).	3. Place the HDD in accordance with the four holes in the bottom.
---	---	---



4. Turn the device upside down and then turn the screws in firmly.



5. Fix the HDD firmly.



6. Connect the HDD cable and power cable.



7. Put the cover in accordance with the clip and then place the upper cover back.



8. Secure the screws in the rear panel and the side panel.

3.2.3 1.5U series

This series DVR max has four SATA HDDs. Please use HDD of 7200rpm or higher.



1. Loosen the screws of the upper cover.



2. Line up the HDD to the four holes of the HDD bracket.



3. Use four screws to fix HDD.



4. Unfasten the HDD power cable.



5. Use the special data cable to connect the HDD and the SATA port



6. Insert the HDD power cable. Close the chassis and fix the screws to secure firmly.

3.2.4 2U series

This series DVR max supports 8 SATA HDDs. Please use HDD of 7200rpm or higher.



1. Loosen the screws of the upper cover.

2. Remove the HDD upper bracket

3. Now you can see the bottom bracket



4. Line up the HDD to the four holes of the HDD bracket.



5. Use screws to fix HDD.



6. Install the upper bracket and then Use screws to fix HDD in the bracket.

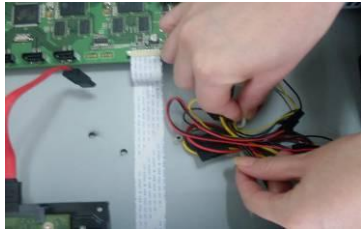

7. Unfasten the HDD power cable.

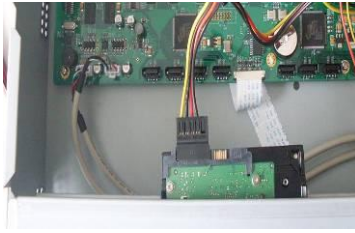

8. Insert the HDD power cable.

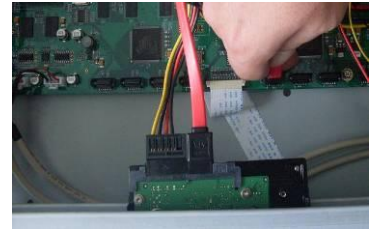

9. Use the special data cable to connect the HDD and the SATA port. Close the chassis and fix the screws to secure firmly.

Important:

If the HDD amount is less than four, you do not need to install the HDD bracket.
When there is a bracket, please make sure the installation direction of HDDs is the same.

3.2.5 Rack Installation

The DVR occupies 1.5U/2U rack units of vertical rack space.

- Use twelve screws to fix the unit
- Please make sure the indoor temperature is below 35°C (95°F).
- Please make sure there is 15cm (6 inches) space around the device to guarantee sound ventilation.
- Please install from the bottom to the top.
- If there are more accessories connected in the rack, please take precaution measures in case the rack power is overload.

3.3 Connecting Power Supply

Please check input voltage and device power button match or not.
We recommend you use UPS to guarantee steady operation, DVR life span, and other peripheral equipments operation such as cameras.

3.4 Connecting Video Input and Output Devices

3.4.1 Connecting Video Input

The video input interface is BNC. The input video format includes: PAL/NTSC BNC (1.0V_{p-p}, 75Ω) .

The HD-SDI series input interface is BNC. The input video format: BNC (0.8VP-P, 75Ω) ,
The video signal should comply with your national standards.

The input video signal shall have high SNR, low distortion; low interference, natural color and suitable lightness.

Guarantee the stability and reliability of the camera signal:

The camera shall be installed in a cool, dry place away from direct sunlight, inflammable, explosive substances and etc.

The camera and the DVR should have the same grounding to ensure the normal operation of the camera.

Guarantee stability and reliability of the transmission line

Please use high quality, sound shielded BNC. Please select suitable BNC model according to the transmission distance.

If the distance is too long, you should use twisted pair cable, and you can add video compensation devices or use optical fiber to ensure video quality.

You should keep the video signal away from the strong electromagnetic interference, especially the high tension current.

Keep connection lugs in well contact

The signal line and shielded wire should be fixed firmly and in well connection. Avoid dry joint, lap welding and oxidation.

3.4.2 Connecting Video Output

Video output includes a BNC(PAL/NTSC, 1.0VP- P, 75Ω) output, a VGA output and a HDMI output.

System supports BNC, VGA and HDMI output at the same time.

When you are using pc-type monitor to replace the monitor, please pay attention to the following points:

- To defer aging, do not allow the pc monitor to run for a long time.
- Regular demagnetization will keep device maintain proper status.
- Keep it away from strong electromagnetic interference devices.

Using TV as video output device is not a reliable substitution method. You also need to reduce the working hour and control the interference from power supply and other devices. The low quality TV may result in device damage.

3.5 Connecting Audio Input & Output, Bidirectional Audio

3.5.1 Audio Input

BNC port is adopted for audio input port.

Due to high impedance of audio input, please use active sound pick-up.

Audio transmission is similar to video transmission. Try to avoid interference, dry joint, loose contact and it shall be away from high tension current.

3.5.2 Audio Output

The audio output signal parameter is usually over 200mv 1K Ω (BNC). It can directly connect to low impedance earphone, active sound box or amplifier-drive audio output device.

If the sound box and the pick-up cannot be separated spatially, it is easy to arouse squeaking. In this case you can adopt the following measures:

- Use better sound pick-up with better directing property.
- Reduce the volume of the sound box.
- Using more sound-absorbing materials in decoration can reduce voice echo and improve acoustics environment.
- Adjust the layout to reduce happening of the squeaking.

3.6 Alarm Input and Output Connection

Please read the followings before connecting.

1. Alarm input

- Please make sure alarm input mode is grounding alarm input.
- Grounding signal is needed for alarm input.
- Alarm input needs the low level voltage signal.
- Alarm input mode can be either NC (normal Open) or NO (Normal Close)
- When you are connecting two DVRs or you are connecting one DVR and one other device, please use a relay to separate them,

2. Alarm output

The alarm output port should not be connected to high power load directly (It shall be less than 1A) to avoid high current which may result in relay damage. Please use the contactor to realize the connection between the alarm output port and the load.

3. How to connect PTZ decoder

- Ensure the decoder has the same grounding with DVR, otherwise you may not control the PTZ. Shielded twisted wire is recommended and the shielded layer is used to connect to the grounding.
- Avoid high voltage. Ensure proper wiring and some thunder protection measures.
- For too long signal wires, 120Ω should be parallel connected between A, B lines on the far end to reduce reflection and guarantee the signal quality.
- “485 A, B” of DVR cannot parallel connect with “485 port” of other device.
- The voltage between of A,B lines of the decoder should be less than 5v.

4. Please make sure the front-end device has soundly earthed.

Improper grounding may result in chip damage.

3.6.1 Alarm Input and Output Details

Important

Please refer to the specifications for the alarm input and output channel amount. Do not merely count the alarm input and out channel amount according to the ports on the rear panel.

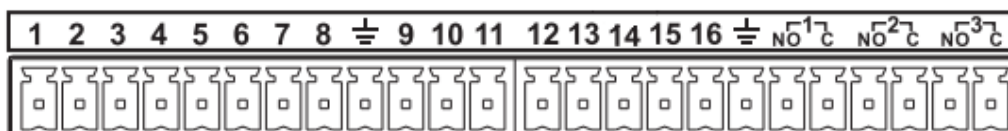

Figure 3-1

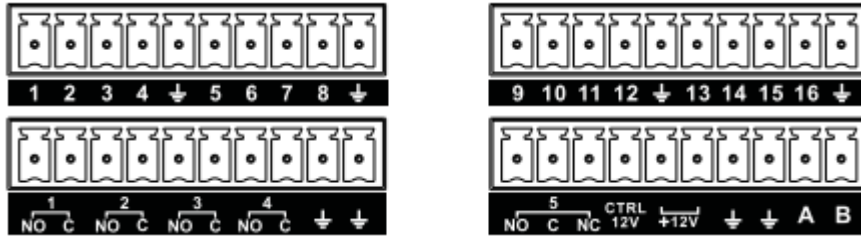

Figure 3-2

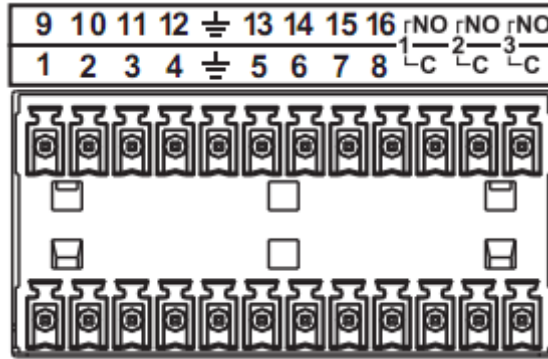

Figure 3-3

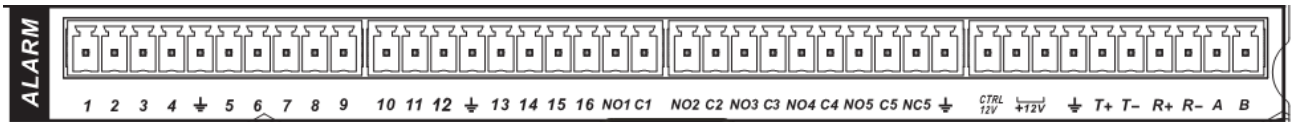

Figure 3-4

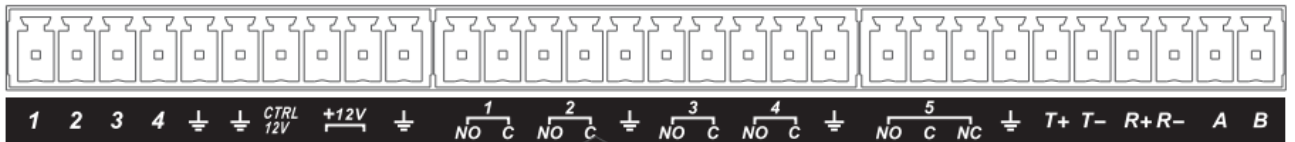

Figure 3-5

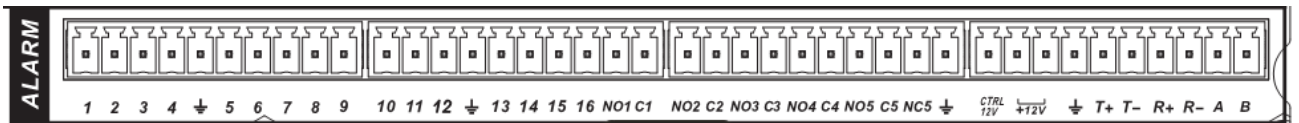

Figure 3-6

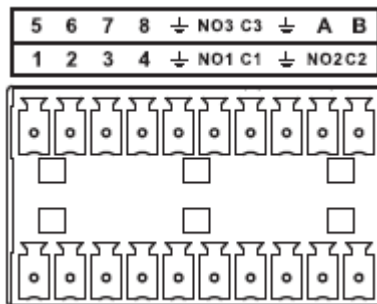

Figure 3-7

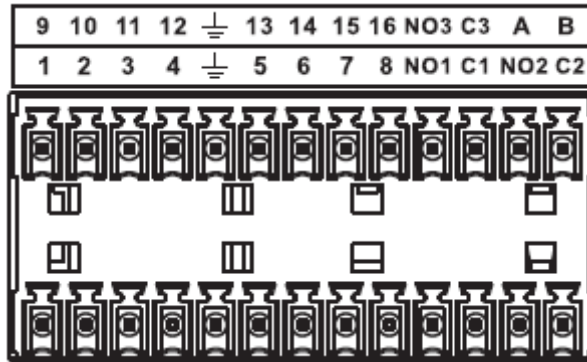



Figure 3-8

In the first line, from the left to the right,: 1, 2, 3, 4, 5, 6, 7, 8, 9, 10, 11, 12, 13, 14, 15, 16	ALARM 1 to ALARM 16. The alarm becomes active in low voltage.
In the second line, from the left to the right: NO1 C1, NO2 C2, NO3 C3, NO4 C4, NO5 C5 NC5	The first four are four groups of normal open activation output (on/off button) NO5 C5 NC5 is a group of NO/NC activation output (on/off button)
CTRL 12V	Control power output. For external alarm, you need to close the device power to cancel the alarm.
+12V	It is external power input. Need the peripheral equipment to provide +12V power (below 1A).
	Earth cable.
485 A/B	485 communication port. They are used to control devices such as decoder.
T+,T-,R+,R-	They are four-wire double duplex RS485 port T+ T-: output wire R+ R-: input wire

3.6.2 Alarm Input Port

Please refer to the following sheet for more information.

- Grounding alarm inputs. Normal open or Normal close type)
- Please parallel connect COM end and GND end of the alarm detector (Provide external power to the alarm detector).

- Please parallel connect the Ground of the DVR and the ground of the alarm detector.
- Please connect the NC port of the alarm sensor to the DVR alarm input(ALARM)
- Use the same ground with that of DVR if you use external power to the alarm device.

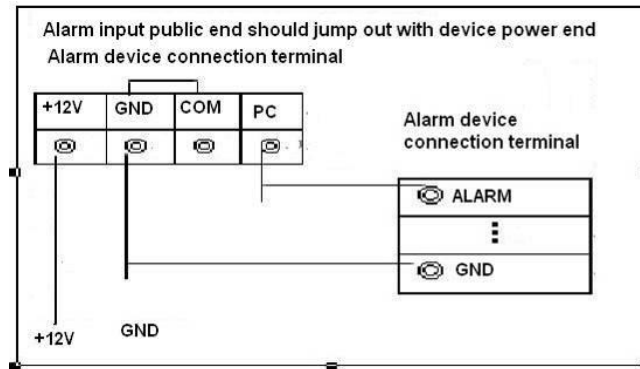

Figure 3-9

3.6.3 Alarm Output Port

- Provide external power to external alarm device.
- To avoid overloading, please read the following relay parameters sheet carefully.
- RS485 A/B cable is for the A/B cable of the PTZ decoder.
- T+,T-,R+,R- are four-wire double duplex RS485 port.
T+ T-: output wire
R+ R-: input wire

Relay Specification

Model:	JRC-27F	
Material of the touch	Silver	
Rating (Resistance Load)	Rated switch capacity	30VDC 2A, 125VAC 1A
	Maximum switch power	125VA 160W
	Maximum switch voltage	250VAC, 220VDC
	Maximum switch current	1A
Insulation	Between touches with same polarity	1000VAC 1minute
	Between touches with different polarity	1000VAC 1minute
	Between touch and winding	1000VAC 1minute
Surge voltage	Between touches with same polarity	1500V (10×160us)
Length of open time	3ms max	
Length of close time	3ms max	
Longevity	Mechanical	50×10 ⁶ times (3Hz)

	Electrical	200×103 times (0.5Hz)
Temperature	-40°C ~+70°C	

3.7 RS485

When the DVR receives a camera control command, it transmits that command up the coaxial cable to the PTZ device. RS485 is a single-direction protocol; the PTZ device can't return any data to the unit. To enable the operation, connect the PTZ device to the RS485 (A,B) input on the DVR.

Since RS485 is disabled by default for each camera, you must enable the PTZ settings first. This series DVRs support multiple protocols such as Pelco-D, Pelco-P.

To connect PTZ devices to the DVR:

1. Connect RS485 A,B on the DVR rear panel.
2. Connect the other end of the cable to the proper pins in the connector on the camera.
3. Please follow the instructions to configure a camera to enable each PTZ device on the DVR.

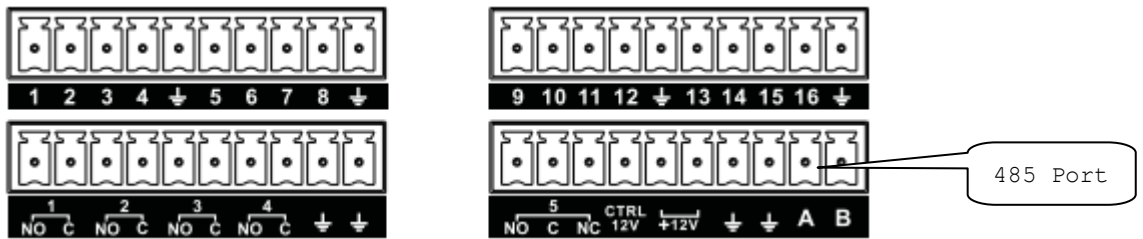

Figure 3-10



Figure 3-11

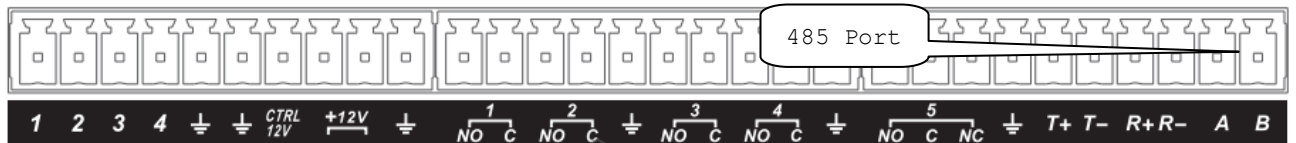

Figure 3-12

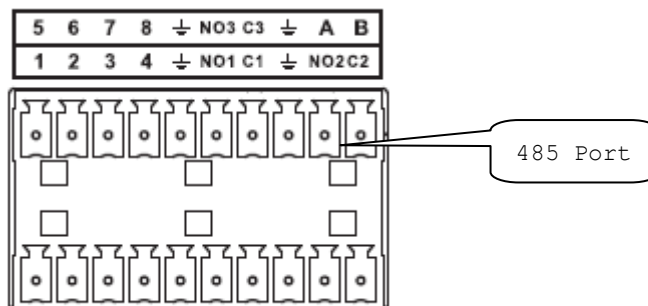

Figure 3-13

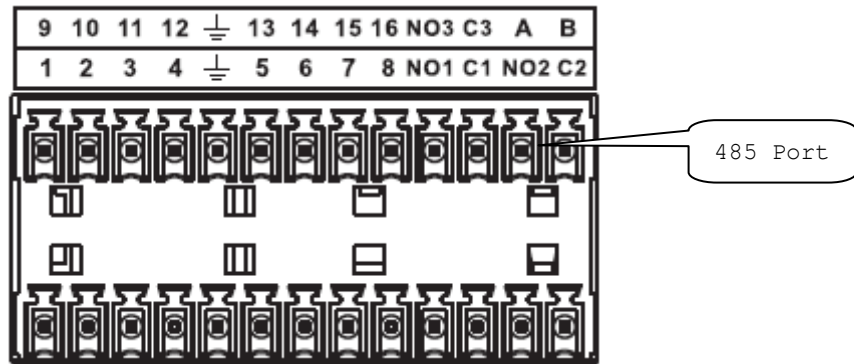

Figure 3-14

3.8 Other Interfaces

There are still other interfaces on the DVR, such as USB ports.

4 Overview of Navigation and Controls

4.1 Boot up and Shutdown

4.1.1 Boot up

Before the boot up, please make sure:

- The rated input voltage matches the device power on-off button. Please make sure the power wire connection is OK. Then click the power on-off button.
- Always use the stable current, if necessary UPS is a best alternative measure.

Please follow the steps listed below to boot up the device.

- Connect the device to the monitor and then connect a mouse.
- Connect power cable.
- Click the power button at the front or rear panel and then boot up the device. After device booted up, the system is in multiple-channel display mode by default.

4.1.2 Shutdown

Note

- When you see corresponding dialogue box "System is shutting down..." Do not click power on-off button directly.
- Do not unplug the power cable or click power on-off button to shutdown device directly when device is running (especially when it is recording.)

There are three ways for you to log out.

- a) Main menu (**RECOMMENDED**)

From Main Menu->Shutdown, select shutdown from dropdown list.

Click OK button, you can see device shuts down.

- b) From power on-off button on the front panel or remote control

Press the power on-off button on the DVR front panel or remote control for more than 3 seconds to shutdown the device.

- c) From power on-off button on the rear panel.

4.1.3 Auto Resume after Power Failure

The system can automatically backup video and resume previous working status after power failure.

4.1.4 Replace Button Battery

Please make sure to use the same battery model if possible.

We recommend replace battery regularly (such as one-year) to guarantee system time accuracy.

Note:

Before replacement, please save the system setup, otherwise, you may lose the data completely!

4.2 Startup Wizard

After device successfully booted up, it goes to startup wizard.

Click Cancel/Next button, you can see system goes to login interface.

Tips

Check the box Startup button here, system goes to startup wizard again when it boots up the next time.

Cancel the Startup button, system goes to the login interface directly when it boots up the next time.



Figure 4-1

Click Cancel button or Next Step button, system goes to login interface. See Figure 4-2.

System consists of four accounts:

- **Username:** admin. **Password:** admin. (administrator, local and network)
- **Username:** 888888. **Password:** 888888. (administrator, local only)
- **Username:** 666666. **Password:** 666666 (Lower authority user who can only monitor, playback, backup and etc.)
- **Username:** default. **Password:** default (hidden user). Hidden user "default" is for system interior use only and can not be deleted. When there is no login user, hidden user "default" automatically login. You can set some rights such as monitor for this user so that you can view some channel view without login.

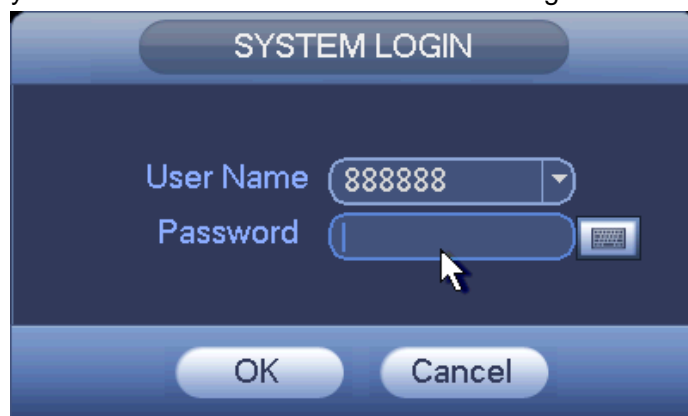

Figure 4-2

Note:

For security reason, please modify password after you first login.

Within 30 minutes, three times login failure will result in system alarm and five times login failure will result in account lock!

Click OK button, you can go to General interface. See Figure 4-3.

For detailed information, please refer to chapter 4.10.5.1.

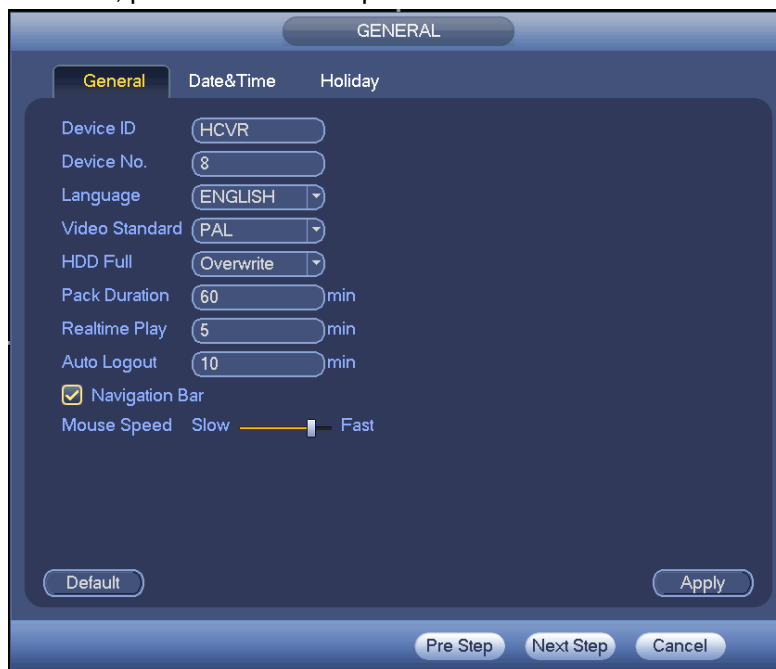

Figure 4-3

Click Next button, you can go to network interface. See Figure 4-4

For detailed information, please refer to chapter 4.9.3.



Figure 4-4

Click Next button, you can go to Schedule interface. See Figure 4-5.
For detailed information, please refer to chapter 4.10.4.1.1.



Figure 4-5

Click Finish button, system pops up a dialogue box. Click the OK button, the startup wizard is complete. See Figure 4-6.

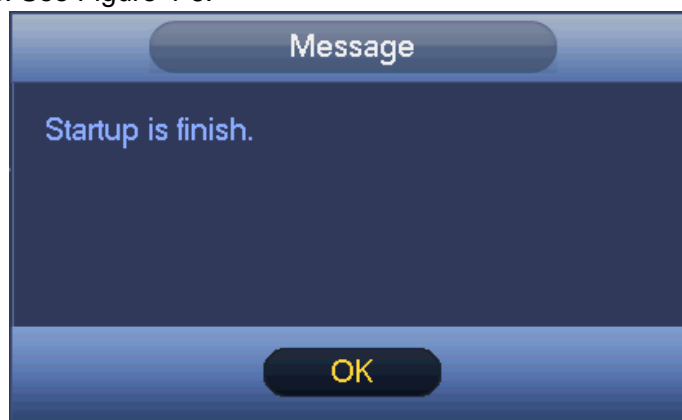

Figure 4-6

4.3 Manual Record

4.3.1 Live Viewing

After you logged in, the system is in live viewing mode. You can see system date, time, channel name and window No. If you want to change system date and time, you can refer to general settings (Main Menu->Setting->System->General). If you want to modify the channel name, please refer to the display settings (Main

Menu->Camera->CAM name)

1		Recording status	3		Video loss
2		Motion detection	4		Camera lock

Tips

- Preview drag: If you want to change position of channel 1 and channel 2 when you are previewing, you can left click mouse in the channel 1 and then drag to channel 2, release mouse you can switch channel 1 and channel 2 positions.
- Use mouse middle button to control window split: You can use mouse middle button to switch window split amount.

Preview Control

The preview control function has the following features.

- Support preview playback.
 - ◇ In the preview desktop, system can playback previous 5-60 minutes record of current channel. Please go to the Main Menu->General to set real-time playback time.
 - ◇ Support drag and play function. You can use your mouse to select any playback start time.
 - ◇ Support playback, pause and exit function.
 - ◇ Right now, system does not support slow playback and backward playback function.
- Support digital zoom function.
- Support real-time backup function.

You can follow the contents listed below for the operation instruction.

Preview control interface

Move you mouse to the top centre of the video of current channel, you can see system pops up the preview control interface. See Figure 4-7. If your mouse stays in this area for more than 6 seconds and has no operation, the control bar automatically hides.



Figure 4-7

1) Realtime playback

It is to playback the previous 5-60 minutes record of current channel.



Please go to the Main menu->Setting->>System->General to set real-time playback time.

System may pop up a dialogue box if there is no such record in current channel.

2) Digital zoom

It is to zoom in specified zone of current channel. It supports zoom in function of

multiple-channel.

Click button , the button is shown as .

There are two ways for you to zoom in.

- Drag the mouse to select a zone, you can view an interface show as Figure 4-8.



Figure 4-8

- Put the middle button at the centre of the zone you want to zoom in, and move the mouse, you can view an interface shown as in Figure 4-9.



Figure 4-9

Right click mouse to cancel zoom and go back to the original interface.

3) Manual record function

It is to backup the video of current channel to the USB device. System can not backup the video of multiple-channel at the same time.

Click button , system begins recording. Click it again, system stops recording. You can find the record file on the flash disk.

4) Manual Snapshot

Click  to snapshot 1-5 times. The snapshot file is saved on the USB device or HDD.

You can go to the Search interface (chapter 4.8.1) to view.

5) Mute

Click to mute. Click again to enable audio function when preview.

Please note this function is for one-window mode only.

4.4 Right-Click Menu

On the preview interface, right click mouse, you can view menu interface shown as in Figure 4-10.

Tips

After you go to the corresponding interface, right click mouse to go back to the

upper-level.

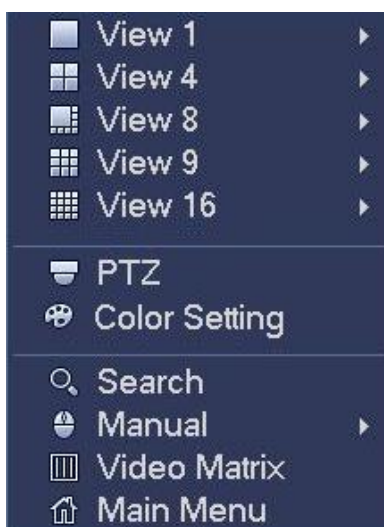

Figure 4-10

4.4.1 Window Switch

System supports 1/4/8/9-window. You can select from the dropdown list. See Figure 4-11.

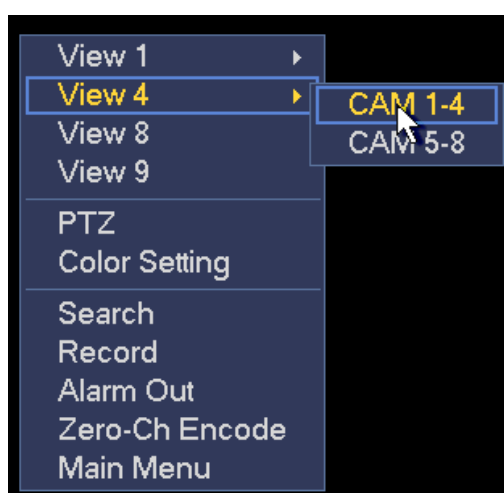

Figure 4-11

4.4.2 PTZ Control



The PTZ setup is shown as in See Figure 4-12.

Please note the commend name is grey once device does not support this function.

The PTZ operation is only valid in one-window mode.

Here you can control PTZ direction, speed, zoom, focus, iris, preset, tour, scan, pattern aux function, light and wiper, rotation and etc.

Speed is to control PTZ movement speed. The value ranges from 1 to 8. The speed 8 is faster than speed 1. You can use the remote control to click the small keyboard to set.

You can click  and  of the zoom, focus and iris to zoom in/out, definition and brightness.

The PTZ rotation supports 8 directions. If you are using direction buttons on the front panel, there are only four directions: up/down/left/right.

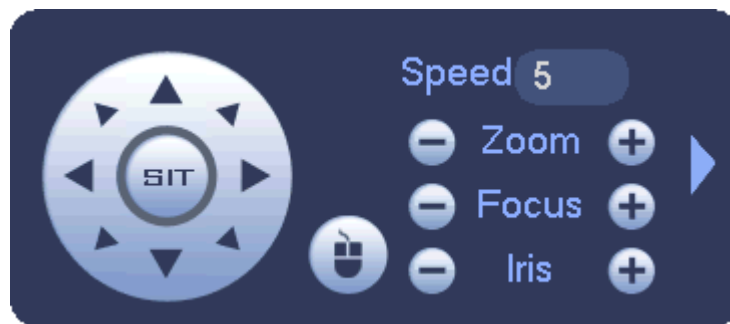

Figure 4-12

In the middle of the eight direction arrows, there is a 3D intelligent positioning key. See Figure 4-13. Please make sure your protocol supports this function and you need to use mouse to control.

Click this key, system goes back to the single screen mode. Drag the mouse in the screen to adjust section size. The dragged zone supports 4X to 16X speeds. It can realize PTZ automatically. The smaller zone you dragged, the higher the speed.



Figure 4-13

Name	Function key	function	Shortcut key	Function key	function	Shortcut key
Zoom		Near			Far	
Focus		Near			Far	
Iris		close			Open	

In Figure 4-12, click to open the menu, you can set preset, tour, pattern, scan and etc. See Figure 4-14.

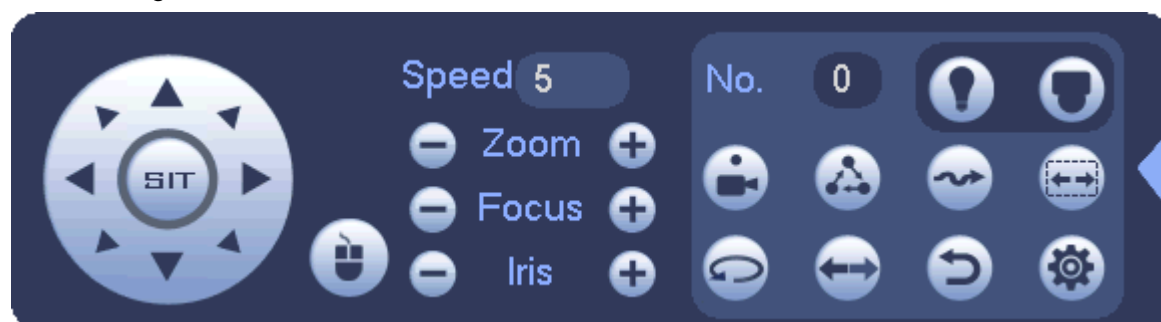











Figure 4-14

Please refer to the following sheet for detailed information.

Please note the above interface may vary due to different protocols. The button is grey and can not be selected once the current function is null.

Right click mouse or click the ESC button at the front panel to go back to the Figure 4-12.

Icon	Function	Icon	Function
	Preset		Flip
	Tour		Reset
	Pattern		Aux
	Scan		Aux on-off button
	Rotate		Go to menu

4.4.2.1 PTZ Function Setup



Click , you can go to the following interface to set preset, tour, pattern, and scan. See Figure 4-15.



Figure 4-15

Preset Setup

In Figure 4-15, click preset button and use eight direction arrows to adjust camera to the proper position. The interface is shown as in Figure 4-16.

Click Set button and then input preset number.

Click Set button to save current preset.



Figure 4-16

Tour Setup

In Figure 4-15, click tour button.

Input tour value and preset No. Click Add preset button to add current preset to the tour.

See Figure 4-17.

Tips

Repeat the above steps to add more presets to the tour. Click Del preset button to remove it from the tour. Please note some protocols do not support delete preset function.



Figure 4-17

Pattern Setup

In Figure 4-15, click Pattern button and input pattern number.

Click Begin button to start direction operation. Or you can go back to Figure 4-12 to operate zoom/focus/iris/direction operation.

In Figure 4-15, click End button.



Figure 4-18

Scan Setup

In Figure 4-15, click Scan button.

Use direction buttons to set camera left limit and then click Left button.



Use direction buttons to set camera right limit and then click Right button. Now the scan setup process is complete.





Figure 4-19

4.4.2.2 Call PTZ Function



Call Preset

In Figure 4-14, input preset value and then click  to call a preset. Click  again to stop call.



Call Pattern

In Figure 4-14, input pattern value and then click  to call a pattern. Click  again to stop call.

Call Tour

In Figure 4-14, input tour value and then click  to call a tour. Click again  to stop call.

Call Scan

In Figure 4-14, input Scan value and then click  to call a tour. Click again  to stop call.

Rotate

In Figure 4-14, click  to enable the camera to rotate.

System supports preset, tour, pattern, scan, rotate, light and etc function.

Note:

- Preset, tour and pattern all need the value to be the control parameters. You can define it as you require.
- You need to refer to your camera user's manual for Aux definition. In some cases, it can be used for special process.

Aux

Click , system goes to the following interface. The options here are defined by the protocol. The aux number is corresponding to the aux on-off button of the decoder. See Figure 4-20.



Figure 4-20

4.4.3 Color

Here you can set hue, brightness, contrast, saturation, gain, white level, color mode and etc. See Figure 4-21.



Figure 4-21

Please refer to the following sheet for detailed information.

Item	Note
Period	There are two periods in one day. You can set different sharpness, brightness, and contrast setup for different periods.
Effective Time	Check the box here to enable this function and then set period time.
Sharpness	The value here is to adjust the edge of the video. The value ranges from 0 to 100. The larger the value is, the clear the edge is and vice versa. Please note there is noise if the value here is too high. The default value is 50 and the recommended value ranges from 40 to 60.
Brightness	It is to adjust monitor window bright. The value ranges from 0 to 100. The default value is 50. The larger the number, the bright the video is. When you input the value here, the bright section and the dark section of the video will be adjusted accordingly. You can use this function when the whole video is too dark or too bright. Please note the video may become hazy if the value is too high. The recommended value ranges from 40 to 60.
Contrast	It is to adjust monitor window contrast. The value ranges from 0 to 100. The default value is 50. The larger the number, the higher the contrast is. You can use this function when the whole video bright is OK but the contrast is not proper. Please note the video may

Item	Note
	become hazy if the value is too low. If this value is too high, the dark section may lack brightness while the bright section may over exposure .The recommended value ranges from 40 to 60.
Saturation	It is to adjust monitor window saturation. The value ranges from 0 to 100. The default value is 50. The larger the number, the strong the color is. This value has no effect on the general brightness of the whole video. The video color may become too strong if the value is too high. For the grey part of the video, the distortion may occur if the white balance is not accurate. Please note the video may not be attractive if the value is too low. The recommended value ranges from 40 to 60.
Gain	The gain adjust is to set the gain value. The default value may vary due to different device models. The smaller the value, the low the noise. But the brightness is also too low in the dark environments. It can enhance the video brightness if the value is high. But the video noise may become too clear.
Color mode	It includes several modes such as standard, color, bright, gentle. Select a color mode, the sharpness, brightness, contrast and etc can automatically switch to corresponding setup.

4.4.4 Search

Please refer to chapter 4.8.1 for detailed information.

4.4.5 Manual Record

Please refer to chapter 4.10.4.3.1 for detailed information.

4.4.6 Alarm Output

Please refer to chapter 4.10.3.4 for detailed information.

4.4.7 Video Matrix

Please refer to chapter 4.10.5.3 for detailed information.

4.5 Navigation Bar

You need to go to the Main menu->Setting->System->General to enable navigation bar function; otherwise you can not see the following interface.

The navigation bar is shown as below. See Figure 4-22.



Figure 4-22

4.5.1 Main Menu

Click button  to go to the main menu interface.

4.5.2 Output Screen

Select corresponding window-split mode and output channels.

4.5.3 Favorites

Click , system pops up the favorites schemes. Click one item, you can view saved favorite channel split mode and channel number. See Figure 4-23.

Please note, right now the favorite scheme name after the window split mode.

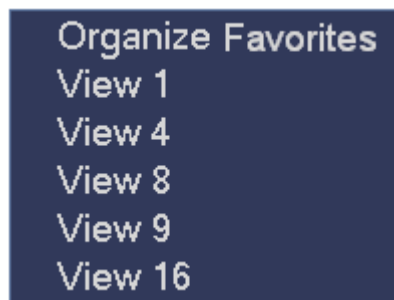





Figure 4-23

4.5.4 Tour

Click button  to enable tour, the icon becomes , you can see the tour is in process.

4.5.5 PTZ

Click , system goes to the PTZ control interface. Please refer to chapter 4.4.2.

4.5.6 Color

Click button , system goes to the color interface. Please refer to chapter 4.4.3.

4.5.7 Search

Click button , system goes to search interface. Please refer to chapter 4.8.1

4.5.8 Alarm Status

Click button , system goes to alarm status interface. It is to view device status and channel status. Please refer to chapter 4.10.3.

4.5.9 Channel Info

Click button , system goes to the channel information setup interface. It is to view information of the corresponding channel. See Figure 4-24.



The screenshot shows a window titled "CHANNEL INFO" with a table of channel settings. The table has columns for Channel, Motion, Video Loss, Tampering Record, Status Record, Mode, Resolution, Frame Rate, and Bit Rate(K). There are 16 rows of data, each representing a channel. The Motion column contains green circles, Video Loss contains red warning icons, Tampering Record contains green circles, Status Record contains green squares, and Mode contains "Manual" for channel 1 and "Regular" for channels 2-16. Resolution is "960*576" for all channels. Frame Rate is "25" for all channels. Bit Rate(K) varies by channel: 95, 23, 96, 69, 23, 70, 68, 70, 70, 120, 69, 71, 71, 70, 70, 71.

Channel	Motion	Video Loss	Tampering Record	Status Record	Mode	Resolution	Frame Rate	Bit Rate(K)
1	●	⚠	●	■	Manual	960*576	25	95
2	●	⚠	●	■	Regular	960*576	25	23
3	●	⚠	●	■	Regular	960*576	25	96
4	●	⚠	●	■	Regular	960*576	25	69
5	●	⚠	●	■	Regular	960*576	25	23
6	●	⚠	●	■	Regular	960*576	25	70
7	●	⚠	●	■	Regular	960*576	25	68
8	●	⚠	●	■	Regular	960*576	25	70
9	●	⚠	●	■	Regular	960*576	25	70
10	●	⚠	●	■	Regular	960*576	25	120
11	●	⚠	●	■	Regular	960*576	25	69
12	●	⚠	●	■	Regular	960*576	25	71
13	●	⚠	●	■	Regular	960*576	25	71
14	●	⚠	●	■	Regular	960*576	25	70
15	●	⚠	●	■	Regular	960*576	25	70
16	●	⚠	●	■	Regular	960*576	25	71

Figure 4-24

4.5.10 Network

Click , system goes to the network interface. It is to set network IP address, default gateway and etc. Please refer to chapter 4.10.2.

4.5.11 HDD Manager

Click , system goes to the HDD manager interface. It is to view and manage HDD information. Please refer to chapter 4.10.4.2.

4.5.12 USB Manager

Click , system goes to the USB Manager interface. It is to view USB information, backup and update. Please refer to chapter 4.8.2, chapter 4.9.4, chapter 4.10.5.9, and chapter 4.10.5.11 for detailed information.

4.6 USB Device Auto Pop-up

After you inserted the USB device, system can auto detect it and pop up the following dialogue box. It allows you to conveniently backup file, log, configuration or update system. See Figure 4-25. Please refer to chapter 4.8.2, chapter 4.9.4, chapter 4.10.5.9, and chapter 4.10.5.11 for detailed information.



Figure 4-25

4.7 Main Menu

The main menu interface is shown as below. See Figure 4-26.

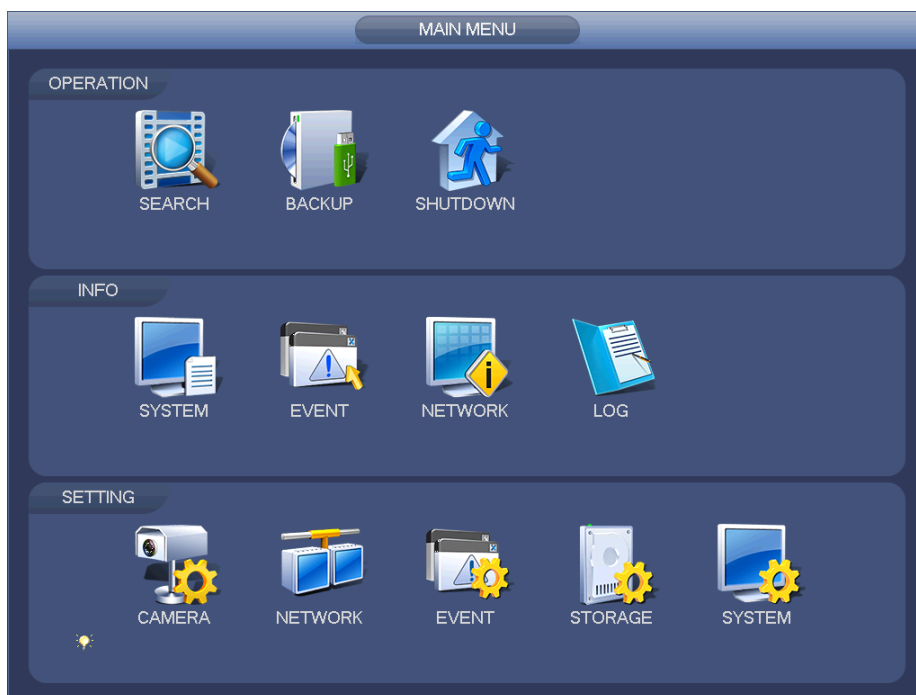

Figure 4-26

4.8 Operation

4.8.1 Search

Click search button in the main menu, search interface is shown as below. See Figure 4-27.

Usually there are three file types:

- R: Regular recording file.
- A: External alarm recording file.
- M: Motion detection recording file

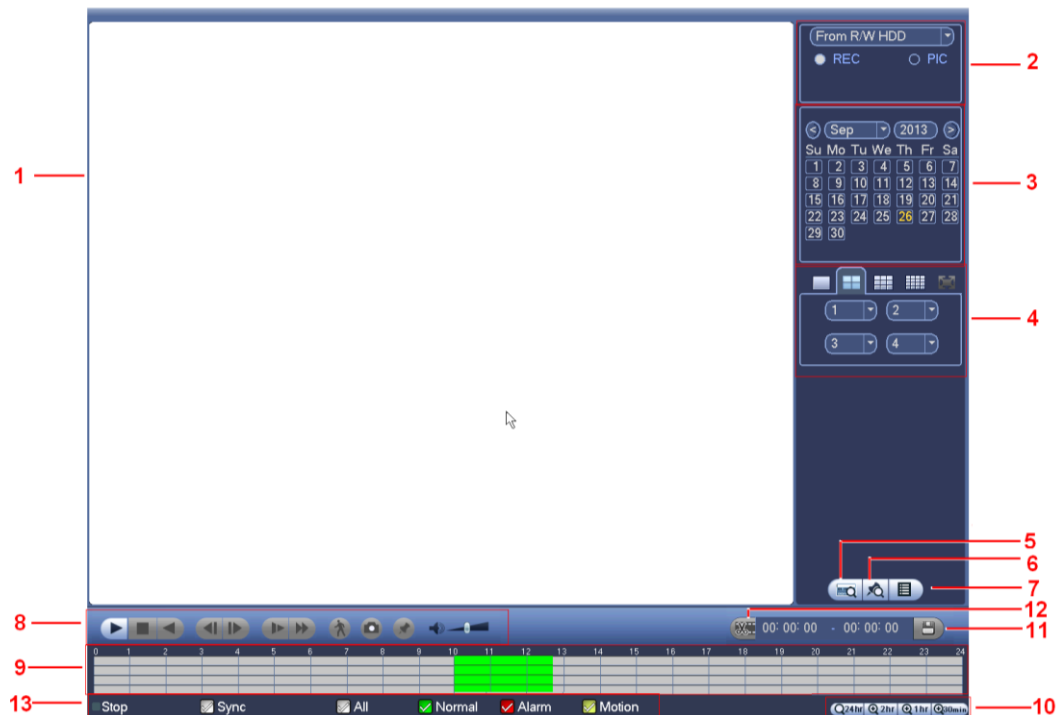









Figure 4-27

Please refer to the following sheet for more information.

SN	Name	Function
1	Display window	<ul style="list-style-type: none"> ● Here is to display the searched picture or file. ● Support 1/4/9/16-window playback. ◇ The 4-channel series product max support 4-channel playback. ◇ The 8-channel series product max support 8-channel playback. ◇ The `6-channel series product max support 16-channel playback.
2	Search type	<ul style="list-style-type: none"> ● Here you can select to search the picture or the recorded file. ● You can select to play from the read-write HDD, from peripheral device or from redundancy HDD. ● Before you select to play from the peripheral device, please connect the corresponding peripheral device. You can view all record files of the root directory of the peripheral device. Click the Browse button; you can select the file you want to play. <p>Important</p> <ul style="list-style-type: none"> ● Redundancy HDD does not support picture backup function, but it supports picture playback function. You can select to play from redundancy

		HDD if there are pictures on the redundancy HDD.	
3	Calendar	<ul style="list-style-type: none"> ● The blue highlighted date means there is picture or file. Otherwise, there is no picture or file. ● In any play mode, click the date you want to see, you can see the corresponding record file trace in the time bar. 	
4	Playback mode and channel selection pane.	<ul style="list-style-type: none"> ● Playback mode: 1/4/9/16. (It may vary due to different series.) ◇ In 1-window playback mode: you can select 1-16 channels. ◇ In 4-window playback mode: you can select 4 channels according to your requirement. ◇ In 9-window playback mode, you can switch between 1-8 and 9-16 channels. ◇ In 16-window playback mode, you can switch between 1-16 and 17-32 channels. ● The time bar will change once you modify the playback mode or the channel option. 	
5	Card number search	<p>The card number search interface is shown as below. Here you can view card number/field setup bar. You can implement advanced search.</p> 	
6	Mark file list button	<p>Click it to go to mark file list interface. You can view all mark information of current channel by time. Please refer to chapter 4.8.1.3 for detailed information. Please note only the product of this icon supports mark function.</p>	
7	File list switch button	<ul style="list-style-type: none"> ● Double click it, you can view the picture/record file list of current day. ● The file list is to display the first channel of the record file. ● The system can display max 128 files in one time. Use the ◀ and ▶ or the mouse to view the file. Select one item, and then double click the mouse or click the ENTER button to playback. ● You can input the period in the following interface to begin accurate search. ● File type: R—regular record; A—external alarm record; M—Motion detect record.  <ul style="list-style-type: none"> ● Lock file. Click the file you want to lock and click the button  to lock. The file you locked will not be overwritten. ● Search locked file: Click the button  to view the locked file. 	
8	Playback control pane.	▶ /	<p>Play/Pause</p> <p>There are three ways for you to begin playback.</p> <ul style="list-style-type: none"> ● The play button ● Double click the valid period of the time bar. ● Double click the item in the file list.

			In slow play mode, click it to switch between play/pause.
		■	Stop
		◀	Backward play In normal play mode, left click the button, the file begins backward play. Click it again to pause current play. In backward play mode, click ▶/ to restore normal play.
		◀/▶	In playback mode, click it to play the next or the previous section. You can click continuously when you are watching the files from the same channel. In normal play mode, when you pause current play, you can click ◀ and ▶ to begin frame by frame playback. In frame by frame playback mode, click ▶/ to restore normal playback.
		▶	Slow play In playback mode, click it to realize various slow play modes such as slow play 1, slow play 2, and etc.
		▶▶	Fast forward In playback mode, click to realize various fast play modes such as fast play 1, fast play 2 and etc.
		Note: The actual play speed has relationship with the software version.	
			Smart search
			The volume of the playback
			Click the snapshot button in the full-screen mode, the system can snapshot 1 picture. System supports custom snap picture saved path. Please connect the peripheral device first, click snap button on the full-screen mode, you can select or create path. Click Start button, the snapshot picture can be saved to the specified path.
			Mark button. Please note this function is for some series product only. Please make sure there is a mark button in the playback control pane. You can refer to chapter 4.8.1.3 for detailed information.
9	Time bar	<ul style="list-style-type: none"> ● It is to display the record type and its period in current search criteria. ● In 4-window playback mode, there are corresponding four time bars. In other playback mode, there is only one time bar. ● Use the mouse to click one point of the color zone in the time bar, system begins playback. ● The time bar is beginning with 0 o'clock when you are setting the configuration. The time bar zooms in the period of the current playback time when you are playing the file. ● The green color stands for the regular record file. The red color stands for the external alarm record file. The yellow stands for the motion detect record file. 	

10	Time bar unit	<ul style="list-style-type: none"> ● The option includes: 24H, 12H, 1H and 30M. The smaller the unit, the larger the zoom rate. You can accurately set the time in the time bar to playback the record. ● The time bar is beginning with 0 o'clock when you are setting the configuration. The time bar zooms in the period of the current playback time when you are playing the file.
11	Backup	<ul style="list-style-type: none"> ● Select the file(s) you want to backup from the file list. You can check from the list. Then click the backup button, now you can see the backup menu. System supports customized path setup. After select or create new folder, click the Start button to begin the backup operation. The record file(s) will be saved in the specified folder. ● Check the file again you can cancel current selection. System max supports to display 32 files from one channel. ● After you clip on record file, click Backup button you can save it. ● For one device, if there is a backup in process, you can not start a new backup operation.
12	Clip	<ul style="list-style-type: none"> ● It is to edit the file. ● Please play the file you want to edit and then click this button when you want to edit. You can see the corresponding slide bars in the time bar of the corresponding channel. You can adjust the slide bar or input the accurate time to set the file end time. ● After you set, you can click Clip button again to edit the second period. You can see the slide bar restore its previous position. ● Click Backup button after clip, you can save current contents in a new file. ● You can clip for one channel or multiple-channel. The multiple-channel click operation is similar with the one-channel operation. <p>Please note:</p> <ul style="list-style-type: none"> ● System max supports 1024 files backup at the same time. ● You can not operate clip operation if there is any file has been checked in the file list.
13	Record type	In any play mode, the time bar will change once you modify the search type.
Other Functions		
14	Smart search	<ul style="list-style-type: none"> ● When system is playing, you can select a zone in the window to begin smart search. Click the motion detect button to begin play. ● Once the motion detect play has begun, click button again will terminate current motion detect file play. ● There is no motion detect zone by default. ● If you select to play other file in the file list, system switches to motion detect play of other file. ● During the motion detect play process, you can not implement operations such as change time bar, begin backward playback or frame by frame playback. ● Please refer to chapter 4.8.1.1 Smart Search for detailed operation.
15	Other	When playing the file, click the number button, system can switch to the same

	channel synchronization switch to play when playback	period of the corresponding channel to play.
16	Digital zoom	When the system is in full-screen playback mode, left click the mouse in the screen. Drag your mouse in the screen to select a section and then left click mouse to realize digital zoom. You can right click mouse to exit.
17	Manually switch channel when playback	During the file playback process, you can switch to other channel via the dropdown list or rolling the mouse. This function is null if there is no record file or system is in smart search process.

4.8.1.1 Smart Search

During the multiple-channel playback mode, double click one channel and then click the



button, system begins smart search. System supports 396(22*18 PAL) and 330(22*15 NTSC) zones. Please left click mouse to select smart search zones. See Figure 4-28.

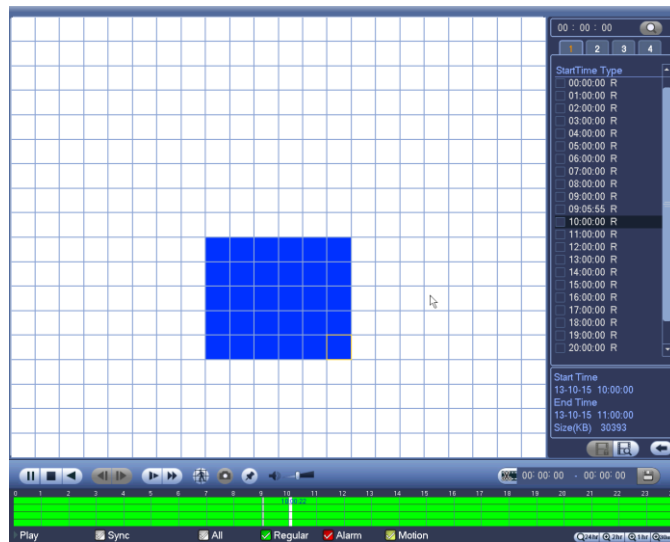

Figure 4-28



Click the button, you can go to the smart search playback. Click it again, system stops smart search playback.

Important

- **System does not support motion detect zone setup during the full-screen mode.**
- **During the multiple-channel playback, system stops playback of rest channels if you implement one-channel smart search.**

4.8.1.2 Accurate playback by time

Select records from one day, click the list, you can go to the file list interface. You can input time at the top right corner to search records by time. See image on the left side of

the Figure 4-29 For example, input time 11:00.00 and then click Search button , you can view all the record files after 11:00.00 (The records includes current time.). See image on the right side of the Figure 4-29 Double click a file name to playback.

Note

- After you searched files, system implement accurate playback once you click Play for the first time.
- System does not support accurate playback for picture.
- System supports synchronization playback and non-synchronous playback. The synchronization playback supports all channels and non-synchronous playback only supports accurately playback of current select channel.

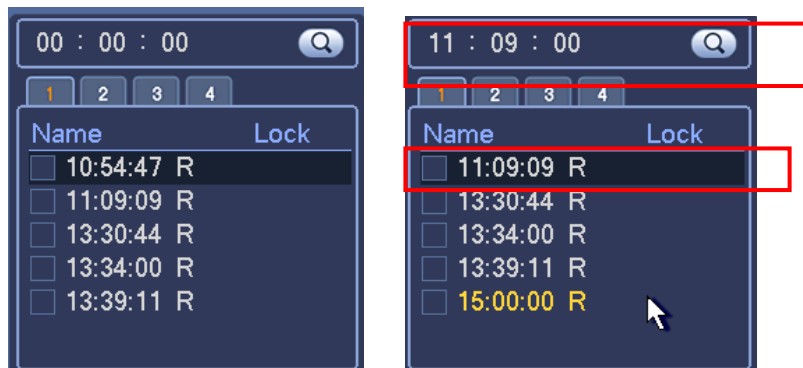

Figure 4-29

4.8.1.3 Mark Playback

Please make sure your purchased device support this function. You can use this function only if you can see the mark playback icon on the Search interface (Figure 4-27).

When you are playback record, you can mark the record when there is important information. After playback, you can use time or the mark key words to search corresponding record and then play. It is very easy for you to get the important video information.

- Add Mark

When system is playback, click Mark button , you can go to the following interface. See Figure 4-30.

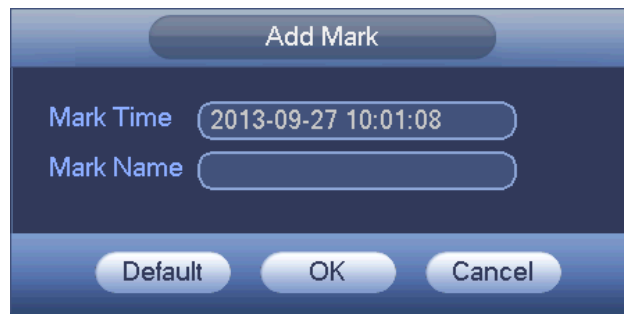



Figure 4-30

- Playback Mark

During 1-window playback mode, click mark file list button  in Figure 4-27, you can go to mark file list interface. Double click one mark file, you can begin playback from the mark time.

- Play before mark time

Here you can set to begin playback from previous N seconds of the mark time.

Note

Usually, system can playbacks previous N seconds record if there is such kind of record file. Otherwise, system playbacks from the previous X seconds when there is such as kind of record.

- Mark Manager

Click the mark manager button  on the Search interface (Figure 4-27); you can go to Mark Manager interface. See Figure 4-31. System can manage all the record mark information of current channel by default. You can view all mark information of current channel by time.

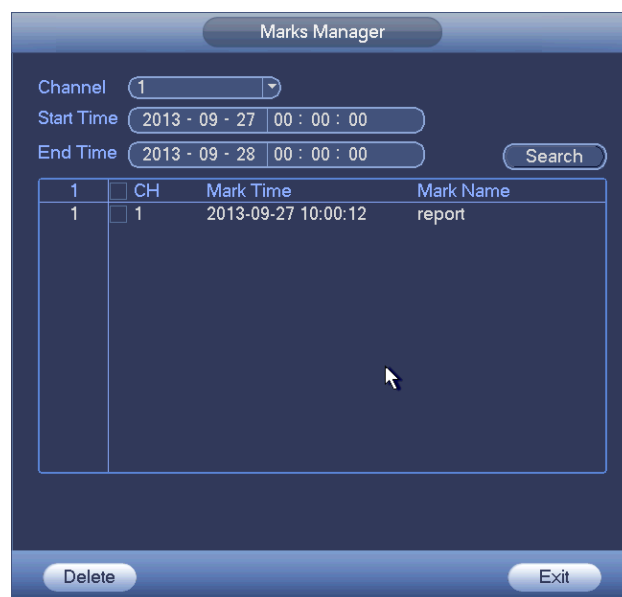

Figure 4-31

- Modify

Double click one mark information item, you can see system pops up a dialogue box for you to change mark information. You can only change mark name here.

- Delete

Here you can check the mark information item you want to delete and then click Delete button, you can remove one mark item. .

Note

- After you go to the mark management interface, system needs to pause current playback. System resume playback after you exit mark management interface.
- If the mark file you want to playback has been removed, system begin playback from the first file in the list.

4.8.2 Backup

DVR support CD-RW, DVD burner, USB device backup, network download and eSATA. Here we introduce USB, eSATA backup. You can refer to Chapter 7 Web Client Operation for network download backup operation.

Click backup button, you can see an interface is shown as in Figure 4-32. Here is for you to view devices information.

You can view backup device name and its total space and free space. The device includes CD-RW, DVD burner, USB device, flash disk, eSATA backup.

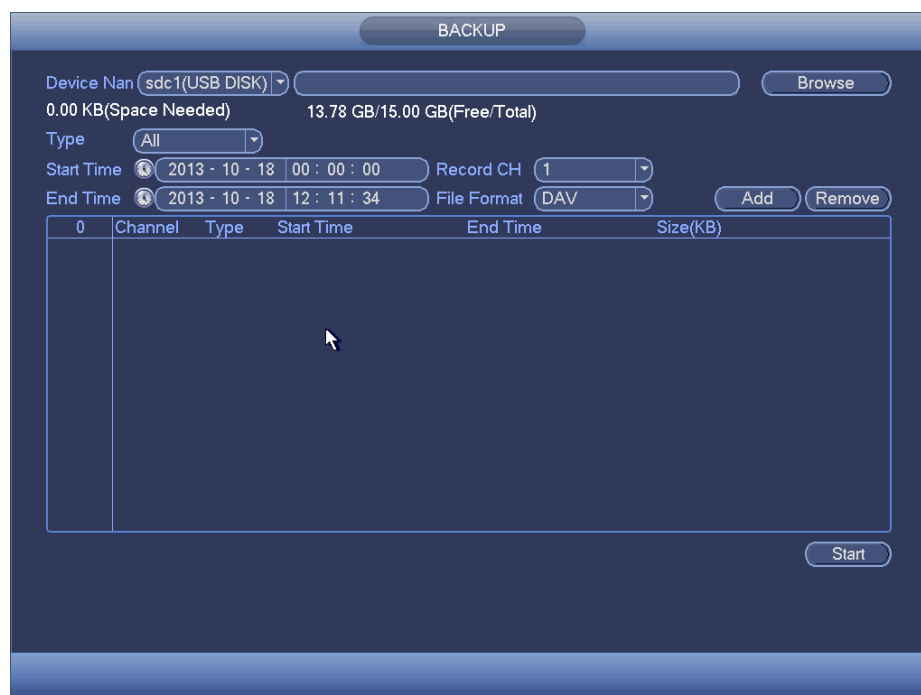

Figure 4-32

Select backup device and then set channel, file start time and end time.

Click add button, system begins search. All matched files are listed below. System automatically calculates the capacity needed and remained. See Figure 4-34.

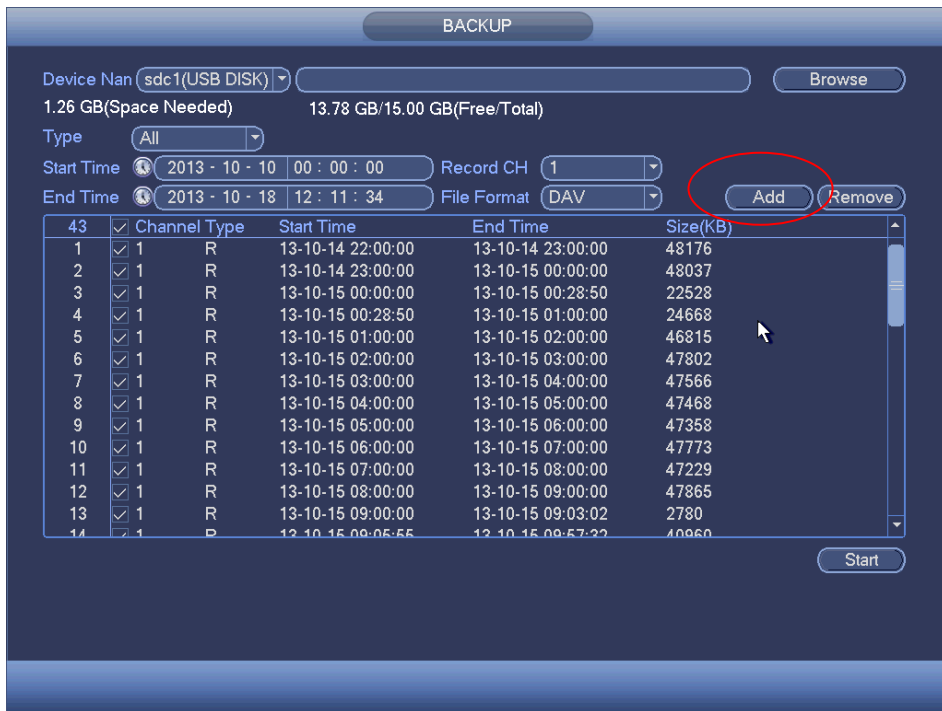

Figure 4-33

System only backup files with a ✓ before channel name. You can use Fn or cancel button to delete ✓ after file serial number.

Click Start button, system begins copy. At the same time, the backup button becomes stop button. You can view the remaining time and process bar at the left bottom. See Figure 4-34.

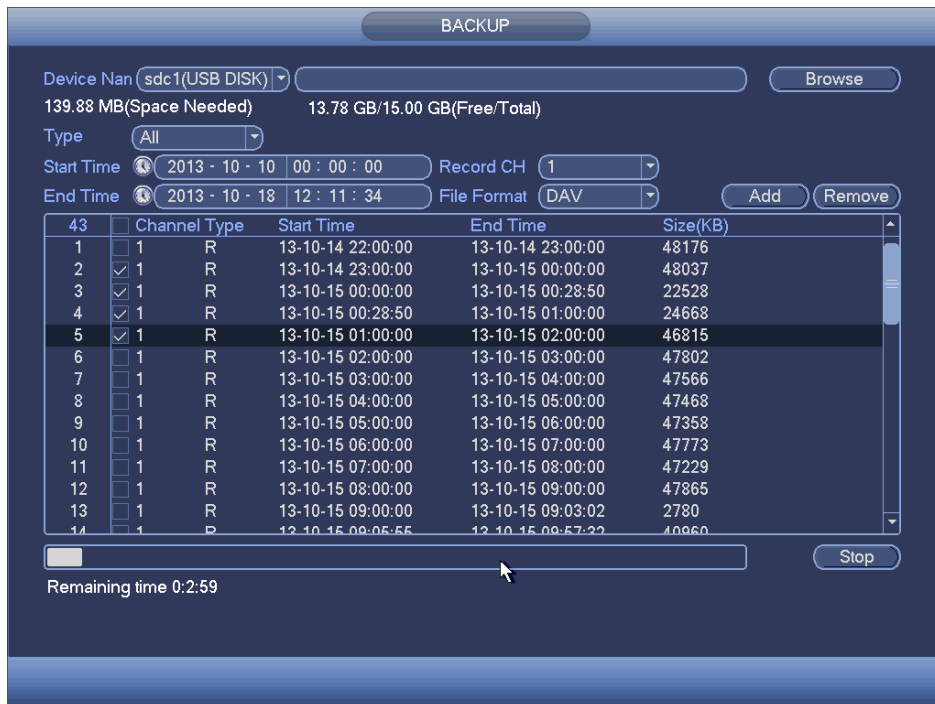

Figure 4-34

When the system completes backup, you can see a dialogue box prompting successful backup.

- File format: Click the file format; you can see there are two options: DAV/ASF. The file name format usually is: Channel number+Record type+Time. In the file name, the YDM format is Y+M+D+H+M+S. File extension name is .dav.

Tips:

During backup process, you can click ESC to exit current interface for other operation. The system will not terminate backup process.

Note:

When you click stop button during the burning process, the stop function becomes activated immediately. For example, if there are ten files, when you click stop system just backup five files, system only save the previous 5 files in the device (But you can view ten file names).

4.8.3 Shut Down

In Figure 4-26, select Shut Down, you can go to the following interface. See Figure 4-35.

There are three options: Shutdown/logout/reboot. See Figure 4-35.

For the user who does not have the shut down right, please input corresponding password to shut down.



Figure 4-35

4.9 Information

4.9.1 System Info

Here is for you to view system information. There are total four items: HDD (hard disk information), record, BPS (data stream statistics), version. See Figure 4-36.



Figure 4-36

4.9.1.1 HDD Information

Here is to list hard disk type, total space, free space, video start time and status. See Figure 4-37.

- SATA: 1-8 here means system max supports 8 HDDS. ○ means current HDD is normal. X means there is error. - means there is no HDD. If disk is damaged, system shows as “?”. Please remove the broken hard disk before you add a new one.
- SN: You can view the HDD amount the device connected to. * means the second HDD is current working HDD.
- Type: The corresponding HDD properties.
- Total space: The HDD total capacity.
- Free space: The HDD free capacity.
- Status: HDD can work properly or not.
- SMART: Display HDD information. See Figure 4-38.



Figure 4-37

Double click one HDD information; you can see the HDD SMART information. See Figure 4-38.

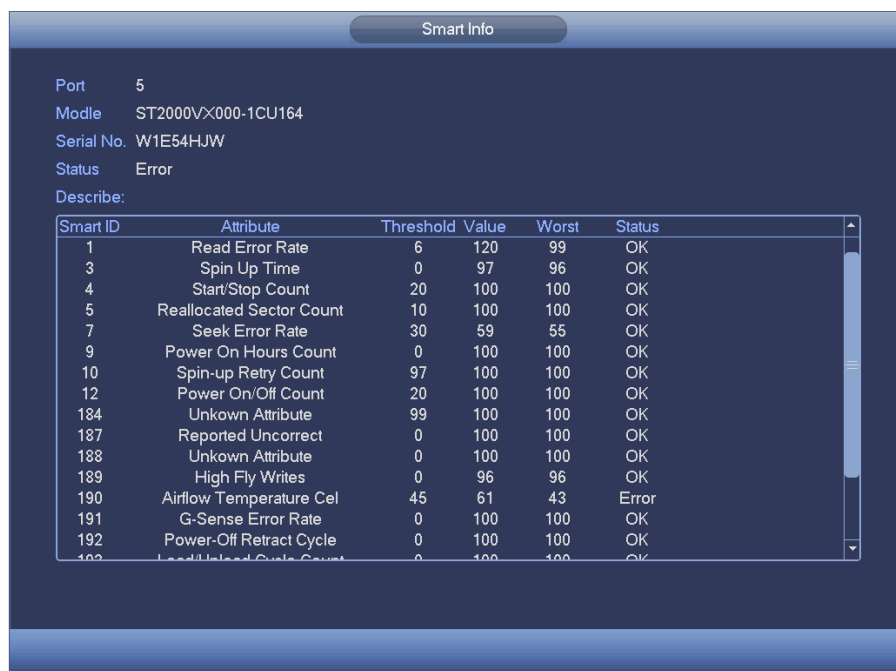

Figure 4-38

4.9.1.2 Record Info

It is to view record start time and end time. See Figure 4-39.

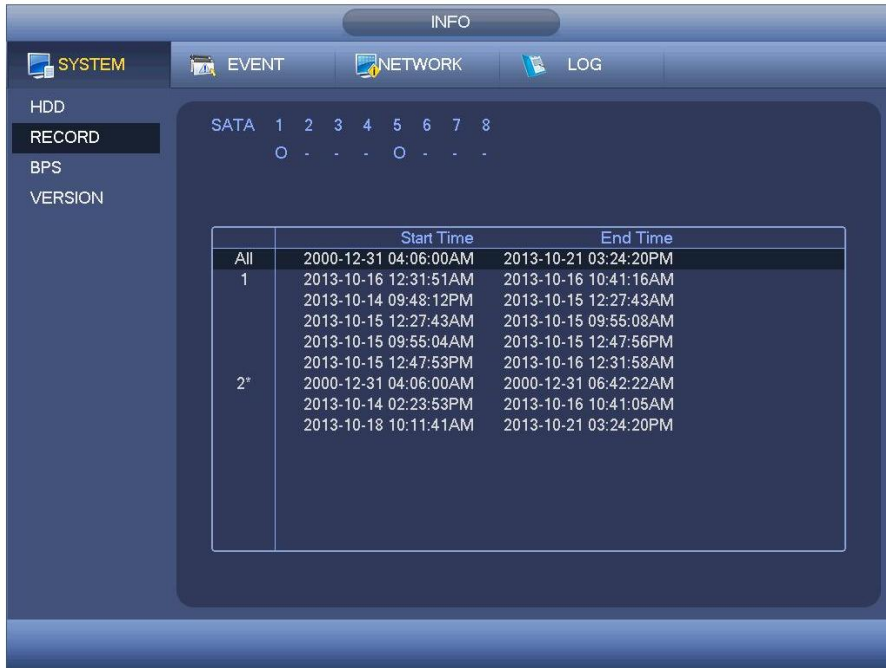

Figure 4-39

4.9.1.3 BPS

Here is for you to view current video data stream (KB/s) and occupied hard disk storage (MB/h). See Figure 4-40.



Figure 4-40

4.9.1.4 Version

Here is for you to view some version information such as version number, built date, serial number and etc. See Figure 4-41.



Figure 4-41

4.9.2 Event

It is to display device status and channel status. See Figure 4-42.



Figure 4-42

4.9.3 Network

4.9.3.1 Online Users

Here is for you to manage online users. See Figure 4-43.
You can disconnect one user or block one user if you have proper system right. Max disconnection setup is 65535 seconds.
System detects there is any newly added or deleted user in each five seconds and refresh the list automatically.

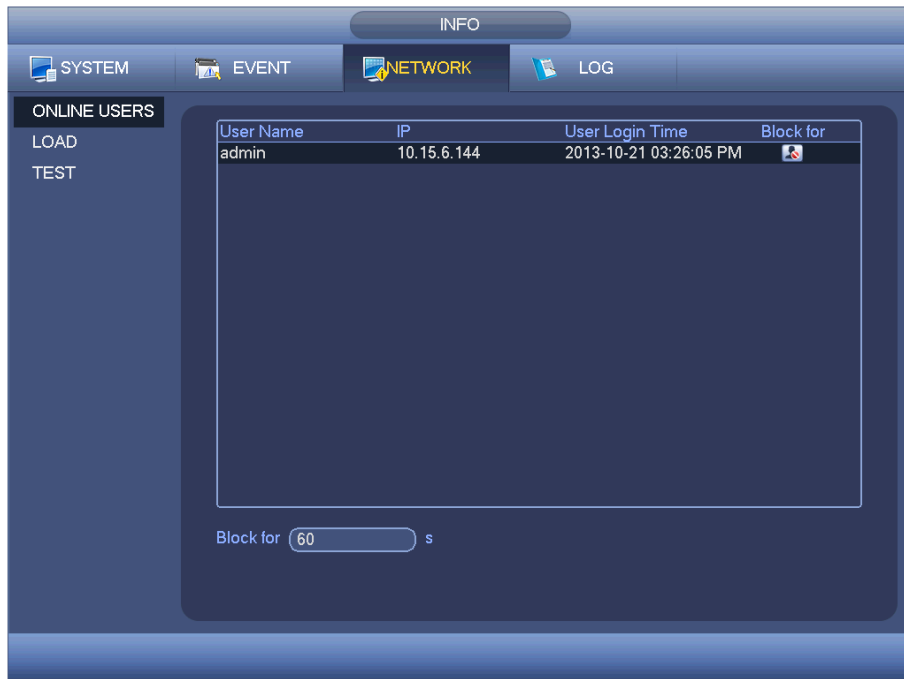

Figure 4-43

4.9.3.2 Network Load

Network load is shown as in Figure 4-44. Here you can view the follow statistics of the device network adapter.

Here you can view information of all connected network adapters. The connection status is shown as offline if connection is disconnected. Click one network adapter, you can view the flow statistics such as send rate and receive rate at the top panel.

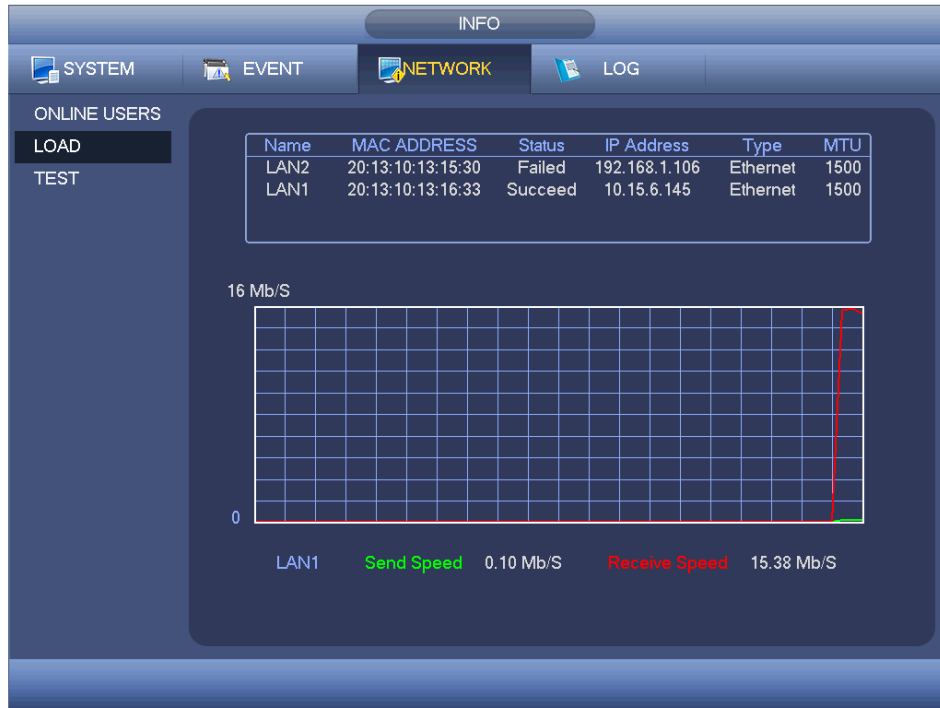



Figure 4-44

4.9.3.3 Network Test

Network test interface is shown as in Figure 4-45.

- Destination IP: Please input valid IPV4 address or domain name.
- Test: Click it to test the connection with the destination IP address. The test results can display average delay and packet loss rate and you can also view the network status as OK, bad, no connection and etc.
- Network Sniffer backup: Please insert USB2.0 device and click the Refresh button, you can view the device on the following column. You can use the dropdown list to select peripheral device. Click Browse button to select the snap path. The steps here are same as preview backup operation.

You can view all connected network adapter names (including Ethernet, PPPoE, WIFI, and 3G), you can click the button  on the right panel to begin Sniffer. Click the grey stop button to stop. Please note system can not Sniffer several network adapters at the same time.

After Sniffer began, you can exit to implement corresponding network operation such as login WEB, monitor. Please go back to Sniffer interface to click  stop Sniffer. System can save the packets to the specified path. The file is named after "Network adapter name+time". You can use software such as Wireshark to open the packets on the PC for the professional engineer to solve complicated problems.

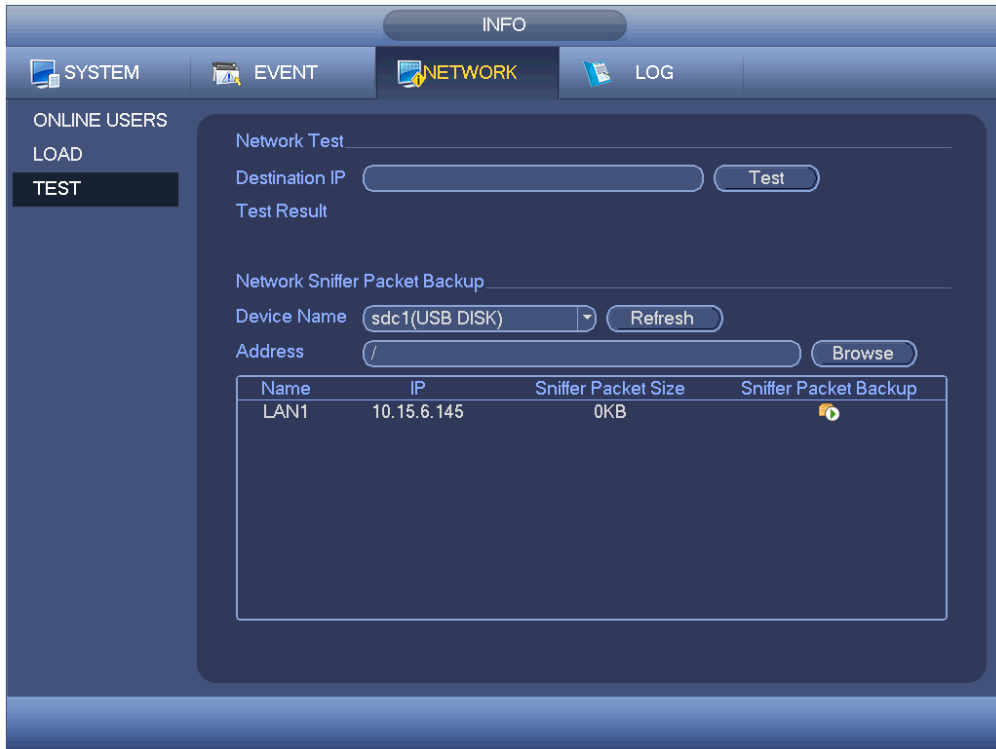

Figure 4-45

4.9.4 Log

4.9.4.1 Local Log

Here is for you to view system log file. System lists the following information. See Figure 4-46.

Log types include system operation, configuration operation, data management, alarm event, record operation, account manager, log clear, file operation and etc. It optimized reboot log. There are only three types: normal reboot, abnormal reboot and protection reboot. 0x02、0x03、0x04 is included in the protection reboot type.

- Start time/end time: Pleased select start time and end time, then click search button. You can view the log files in a list. System max displays 100 logs in one page. It can max save 1024 log files. Please use page up/down button on the interface or the front panel to view more.
- Backup: Please select a folder you want to save; you can click the backup button to save the log files. After the backup, you can see there is a folder named Log_time on the backup path. Double click the folder, you can see the log file
- Details: Click the Details button or double click the log item, you can view the detailed information. See Figure 4-47. Here you can use rolling bar to view information, or you can use Page up/Page down to view other log information.

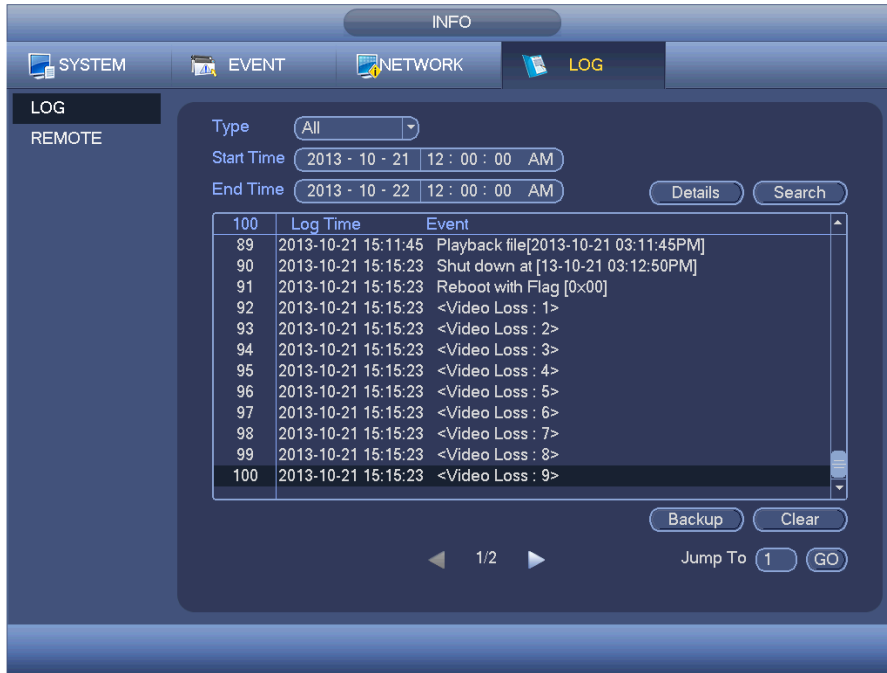

Figure 4-46

Select an item on the list and then click the Details button or double click the log item, you can view the detailed information such as log time, log type, log user, IP address and etc. See Figure 4-47.



Figure 4-47

4.9.4.2 Remote Log

In this interface, you can search the IPC log information of the corresponding channel. It includes IPC online, offline and etc. See Figure 4-48.

You can select a channel from the dropdown list and then set start time and end time.

Click search button, you can view the remote connection log of current channel. You can select another channel (doe not need to click Search button again), you can view remote connection log.



Figure 4-48

4.10 Setting

4.10.1 Camera

4.10.1.1 Camera

The camera interface is shown as below. See Figure 4-49.

- Channel: Select a channel from the dropdown list.
- Saturation: It is to adjust monitor window saturation. The value ranges from 0 to 100. The default value is 50. The larger the number, the strong the color is. This value has no effect on the general brightness of the whole video. The video color may become too strong if the value is too high. For the grey part of the video, the distortion may occur if the white balance is not accurate. Please note the video may not be attractive if the value is too low. The recommended value ranges from 40 to 60.
- Brightness: It is to adjust monitor window bright. The value ranges from 0 to 100. The default value is 50. The larger the number is, the bright the video is. When you input the value here, the bright section and the dark section of the video will be adjusted accordingly. You can use this function when the whole video is too dark or too bright. Please note the video may become hazy if the value is too high. The recommended value ranges from 40 to 60.
- Contrast: It is to adjust monitor window contrast. The value ranges from 0 to 100. The default value is 50. The larger the number is, the higher the contrast is. You can use this function when the whole video bright is OK but the contrast is not proper. Please note the video may become hazy if the value is too low. If this value is too high, the

dark section may lack brightness while the bright section may over exposure .The recommended value ranges from 40 to 60.

- Sharpness: The value here is to adjust the edge of the video. The value ranges from 0 to 100. The larger the value is, the clear the edge is and vice versa. Please note there is noise if the value here is too high. The default value is 50 and the recommended value ranges from 40 to 60.



Figure 4-49

4.10.1.2 Encode

It is to set video bit stream, picture bit stream, video overlay parameter and etc.

4.10.1.2.1 Video

Video setting includes the following items. See Figure 4-50.

- Channel: Select the channel you want.
- Type: Please select from the dropdown list. There are three options: regular/motion detect/alarm. You can set the various encode parameters for different record types.
- Compression: System supports H.264 and MJPEG.
- Resolution: System supports various resolutions, you can select from the dropdown list. Please note the option may vary due to different series.
- Frame rate: It ranges from 1f/s to 25f/s in NTSC mode and 1f/s to 30f/s in PAL mode.
- Bit rate type: System supports two types: CBR and VBR. In VBR mode, you can set video quality.
- Quality: There are six levels ranging from 1 to 6. The sixth level has the highest image quality.
- Video/audio: You can enable or disable the video/audio.
- Audio: Please select from the dropdown list.



Figure 4-50

4.10.1.2.2 Snapshot

Here you can set snapshot mode, picture size, quality and frequency. See Figure 4-51.

- Snapshot mode: There are two modes: regular and trigger. If you set timing mode, you need to set snapshot frequency. If you set trigger snapshot, you need to set snapshot activation operation.
- Image size: Here you can set snapshot picture size.
- Image quality: Here you can set snapshot quality. The value ranges from 1 to 6.
- Interval: It is for you to set timing (schedule) snapshot interval.



Figure 4-51

4.10.1.2.3 Overlay

Overlay interface is shown as in Figure 4-52.

- Cover area: Here is for you to set cover area. You can drag you mouse to set proper section size. In one channel video, system max supports 4 zones in one channel.
- Preview/monitor: privacy mask has two types. Preview and Monitor. Preview means the privacy mask zone can not be viewed by user when system is in preview status. Monitor means the privacy mask zone can not be view by the user when system is in monitor status.
- Time display: You can select system displays time or not when you playback. Please click set button and then drag the title to the corresponding position in the screen.
- Channel display: You can select system displays channel number or not when you playback. Please click set button and then drag the title to the corresponding position in the screen.
- Copy: After you complete the setup, you can click Copy button to copy current setup to other channel(s). You can see an interface is shown as in Figure 4-53. You can see current channel number is grey. Please check the number to select the channel or you can check the box ALL. Please click the OK button in Figure 4-53 and Figure 4-52 respectively to complete the setup.

Please highlight icon  to select the corresponding function.



Figure 4-52

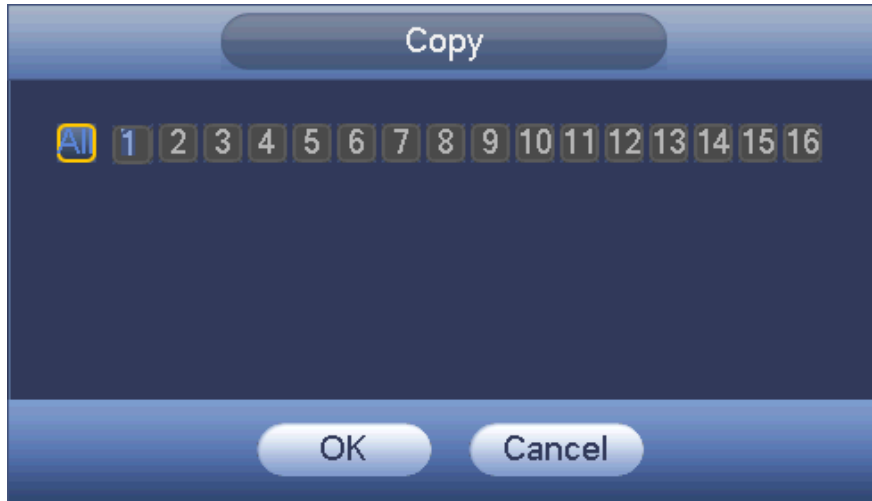

Figure 4-53

4.10.1.2.4 Channel Name

It is to modify channel name. It max supports 31-character. See Figure 4-54.



Figure 4-54

4.10.2 Network

4.10.2.1 TCP/IP

The single network adapter interface is shown as in Figure 4-55 and the dual network adapters interface is shown as in Figure 4-56

- Network Mode : Includes multiple access, fault tolerance, and load balancing
 - ✧ Multiple-address mode: eth0 and eth1 operate separately. You can use the services such as HTTP, RTP service via etho0 or the eth1. Usually you need to

set one default card (default setup is eth0) to request the auto network service from the device-end such as DHCP, email, FTP and etc. In multiple-address mode, system network status is shown as offline once one card is offline.

- ✧ Network fault-tolerance: In this mode, device uses bond0 to communicate with the external devices. You can focus on one host IP address. At the same time, you need to set one master card. Usually there is only one running card (master card). System can enable alternate card when the master card is malfunction. The system is shown as offline once these two cards are both offline. Please note these two cards shall be in the same LAN.
- ✧ Load balance: In this mode, device uses bond0 to communicate with the external device. The eth0 and eth1 are both working now and bearing the network load. Their network load are general the same. The system is shown as offline once these two cards are both offline. Please note these two cards shall be in the same LAN.

- Default Network Card: Please select eth0/eth1/bond0(optional) after enable multiple-access function
- Main Network Card: Please select eth0/eth1 (optional).after enable multiple access function.

Note: Some series support the above three configurations and supports functions as multiple-access, fault-tolerance and load balancing.

- IP Version: There are two options: IPv4 and IPv6. Right now, system supports these two IP address format and you can access via them.
- MAC address: The host in the LAN can get a unique MAC address. It is for you to access in the LAN. It is read-only.
- IP address: Here you can use up/down button (▲▼) or input the corresponding number to input IP address. Then you can set the corresponding subnet mask the default gateway.
- Default gateway: Here you can input the default gateway. Please note system needs to check the validity of all IPv6 addresses. The IP address and the default gateway shall be in the same IP section. That is to say, the specified length of the subnet prefix shall have the same string.
- DHCP: It is to auto search IP. When enable DHCP function, you can not modify IP/Subnet mask /Gateway. These values are from DHCP function. If you have not enabled DHCP function, IP/Subnet mask/Gateway display as zero. You need to disable DHCP function to view current IP information. Besides, when PPPoE is operating, you can not modify IP/Subnet mask /Gateway.
- MTU: It is to set MTU value of the network adapter. The value ranges from 1280-7200 bytes. The default setup is 1500 bytes. Please note MTU modification may result in network adapter reboot and network becomes off. That is to say, MTU modification can affect current network service. System may pop up dialog box for you to confirm setup when you want to change MTU setup. Click OK button to confirm current reboot, or you can click Cancel button to terminate current modification. Before the modification, you can check the MTU of the gateway; the MTU of the DVR shall be the

same as or is lower than the MTU of the gateway. In this way, you can reduce packets and enhance network transmission efficiency.

The following MTU value is for reference only.

- ✧ 1500: Ethernet information packet max value and it is also the default value. It is the typical setup when there is no PPPoE or VPN. It is the default setup of some router, switch or the network adapter.
- ✧ 1492: Recommend value for PPPoE.
- ✧ 1468: Recommend value for DHCP.
- Preferred DNS server: DNS server IP address.
- Alternate DNS server: DNS server alternate address.
- Transfer mode: Here you can select the priority between fluency/video qualities.
- LAN download: System can process the downloaded data first if you enable this function. The download speed is 1.5X or 2.0X of the normal speed.
- LAN download: System can process the downloaded data first if you enable this function. The download speed is 1.5X or 2.0X of the normal speed.

After completing all the setups please click save button, system goes back to the previous menu.



Figure 4-55



Figure 4-56

4.10.2.2 Connection

The connection setup interface is shown as in Figure 4-57.

- Max connection: system support maximal 128 users. 0 means there is no connection limit.
- TCP port: Default value is 37777.
- UDP port: Default value is 37778.
- HTTP port: Default value is 80.
- HTTPS port: Default value is 443.
- RTSP port: Default value is 554.

Important: System needs to reboot after you changed and saved any setup of the above four ports. Please make sure the port values here do not conflict.



Figure 4-57

4.10.2.3 WIFI

The WIFI interface is shown as below. See Figure 4-58.

- Auto connect WIFI: Check the box here, system automatically connects to the previous WIFI hotspot.
- Refresh: You can click it to search the hotspot list again. It can automatically add the information such as the password if you have set it before.
- Disconnect: Here you can click it to turn off the connection.
- Connect: Here you can click it to connect to the hotspot. System needs to turn off current connection and then connect to a new hotspot if there is connection of you selected one.



Figure 4-58

- WIFI working status: Here you can view current connection status.

Please note:

- After successful connection, you can see WIFI connection icon at the top right corner of the preview interface.
- When the hotspot verification type is WEP, system displays as AUTO since the device can not detect its encryption type.
- System does not support verification type WPA and WPA2. The display may become abnormal for the verification type and encryption type.

After device successfully connected to the WIFI, you can view the hotspot name, IP address, subnet mask, default gateway and etc.

4.10.2.4 3G

3G setup interface is shown as below. See Figure 4-59.

Please refer to the following contents for the parameter information.

- Pane 1: Display 3G signal intensity after you enabled 3G function.
- Pane 2: Display 3G module configuration information after you enabled 3G function.
- Pane 3: Display 3G module status information after you enabled 3G function.

It is to display current wireless network signal intensity such as EVDO, CDMA1x, WCDMA, WCDMA, EDGE and etc.

- 3G module: It is to display current wireless network adapter name.
- 3G Enable/Disable: Check the box here to enable 3G module.
- Network type: There are various network types for different 3G network modules. You can select according to your requirements.
- APN: It is the wireless connection server. It is to set you access the wireless network via which method.
- AUTH: It is the authentication mode. It supports PAP/CHAP.
- Dial number: Please input 3G network dialup number you got from your ISP.
- User name: It is the user name for you to login the 3G network.
- Password: It is the password for you to login the 3G network.
- Pulse interval: You can set dialup duration. Once you disable the extra stream, the connection time begins. For example, if you input 5 seconds here, then 3G network connection period is 5 seconds. The device automatically disconnect when time is up. If there is no extra stream, 3G network connection is valid all the time. **If the alive time is 0, then the 3G network connection is valid all the time.**
- Dial: Here you can enable or disable 3G network connection/disconnection manually.
- 3G wireless network: Here is to display wireless network status, SIM card status, dial status. If the 3G connection is OK, then you can see the device IP address the wireless network automatically allocates.

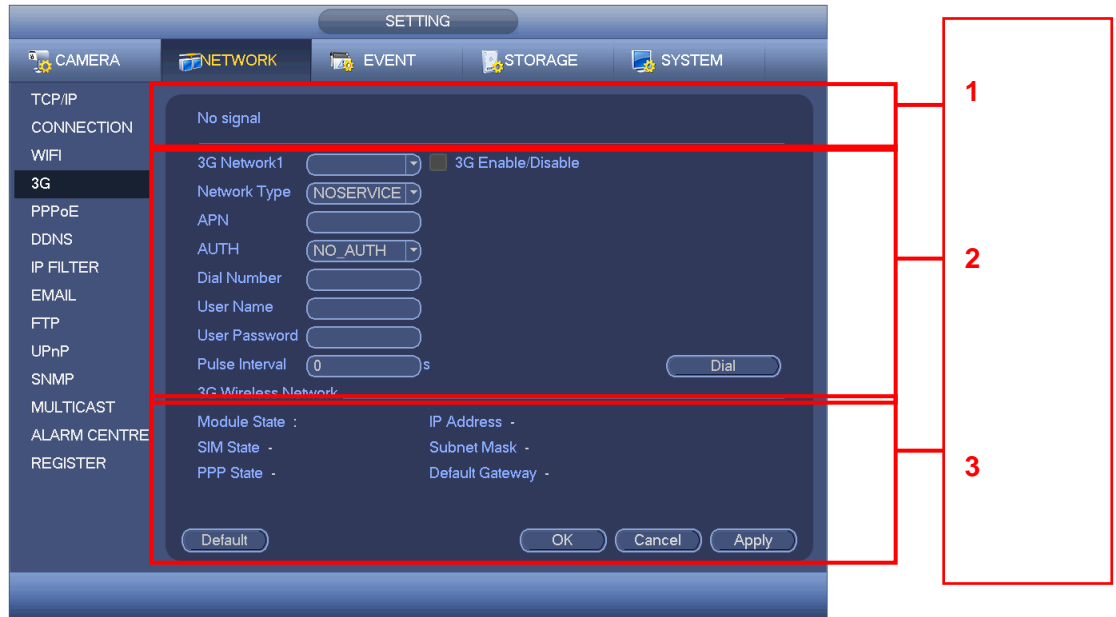

Figure 4-59

4.10.2.5 PPPoE

PPPoE interface is shown as in Figure 4-60.

Input “PPPoE name” and “PPPoE password” you get from your ISP (Internet service provider).

Click save button, you need to restart to activate your configuration.

After rebooting, DVR will connect to internet automatically. The IP in the PPPoE is the DVR dynamic value. You can access this IP to visit the unit.

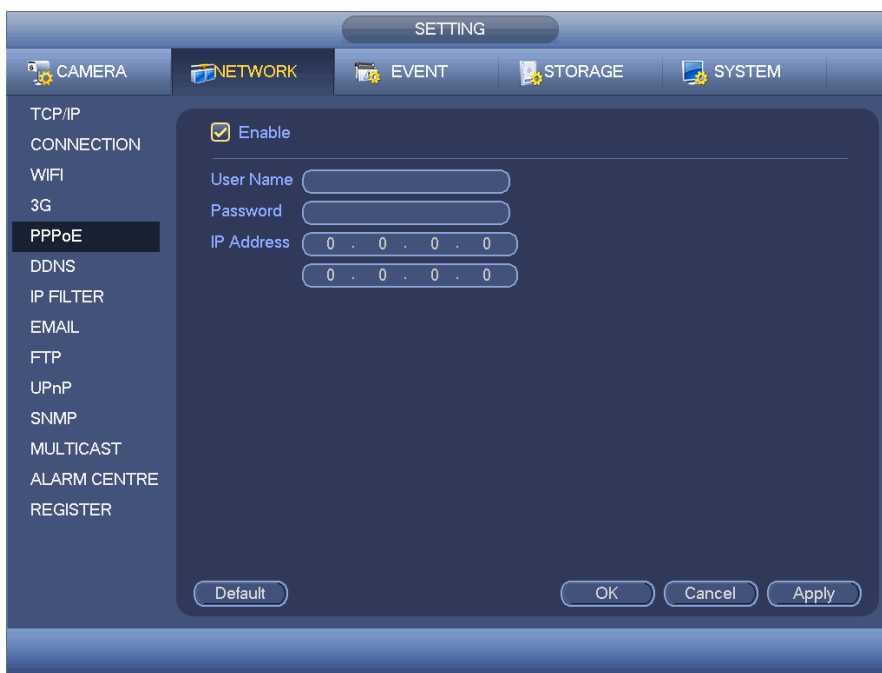

Figure 4-60

4.10.2.6 DDNS Setup

DDNS setup interface is shown as in Figure 4-61.

You need a PC of fixed IP in the internet and there is the DDNS software running in this PC. In other words, this PC is a DNS (domain name server).

In network DDNS, please select DDNS type and highlight enable item. And then please input your PPPoE name you get from you IPS and server IP (PC with DDNS). Click save button and then reboot system.

Click save button, system prompts for rebooting to get all setup activated.

After rebooting, open IE and input as below:

http: //(DDNS server IP)/(virtual directory name)/webtest.htm

e.g.: http: //10.6.2.85/DVR _DDNS/webtest.htm.)

Now you can open DDNSServer web search page.



Figure 4-61

Please note NNDS type includes: CN99 DDNS, NO-IP DDNS, Quick DDNS, Dyndns DDNS and sysdns DDNS. All the DDNS can be valid at the same time, you can select as you requirement.

Private DDNS function shall work with special DDNS server and special Professional Surveillance Software (PSS).

Quick DDNS and Client-end Introduction

1) Background Introduction

Device IP is not fixed if you use ADSL to login the network. The DDNS function allows you to access the DVR via the registered domain name. Besides the general DDNS ,the Quick DDNS works with the device from the manufacturer so that it can add the extension function.

2) Function Introduction

The quick DDNS client has the same function as other DDNS client end. It realizes the bonding of the domain name and the IP address. Right now, current DDNS server is for our own devices only. You need to refresh the bonding relationship of the domain and the IP regularly. There is no user name, password or the ID registration on the server. At the same time, each device has a default domain name (Generated by MAC address) for your option. You can also use customized valid domain name (has not registered.).

3) Operation

Before you use Quick DDNS, you need to enable this service and set proper server address, port value and domain name.

- Server address: www.quickddns.com
- Port number: 80
- Domain name: There are two modes: Default domain name and customized domain name.

Except default domain name registration, you can also use customized domain name (You can input your self-defined domain name.) After successful registration, you can use domain name to login installed of the device IP.

- User name: It is optional. You can input your commonly used email address.

Important

- Do not register frequently. The interval between two registrations shall be more than 60 seconds. Too many registration requests may result in server attack.
- System may take back the domain name that is idle for one year. You can get a notification email before the cancel operation if your email address setup is OK.

4.10.2.7 IP Filter

IP filter interface is shown as in Figure 4-62. You can add IP in the following list. The list supports max 64 IP addresses. System supports valid address of IPv4 and IPv6. **Please note system needs to check the validity of all IPv6 addresses and implement optimization.**

After you enabled trusted sites function, only the IP listed below can access current DVR. If you enable blocked sites function, the following listed IP addresses can not access current DVR.

- Enable: Highlight the box here, you can check the trusted site function and blocked sites function. You can not see these two modes if the Enable button is grey.
- Type: You can select trusted site and blacklist from the dropdown list. You can view the IP address on the following column.
- Start address/end address: Select one type from the dropdown list, you can input IP address in the start address and end address. Now you can click Add IP address or Add IP section to add.
 - a) For the newly added IP address, it is in enable status by default. Remove the before the item, and then current item is not in the list.
 - b) System max supports 64 items.
 - c) Address column supports IPv4 or IPv6 format. If it is IPv6 address, system can optimize it. For example, system can optimize aa:0000: 00: 00aa: 00aa: 00aa:

00aa: 00aa as aa:: aa: aa: aa: aa: aa: aa.

- d) System automatically removes space if there is any space before or after the newly added IP address.
 - e) System only checks start address if you add IP address. System check start address and end address if you add IP section and the end address shall be larger than the start address.
 - f) System may check newly added IP address exists or not. System does not add if input IP address does not exist.
- Delete: Click it to remove specified item.
 - Edit: Click it to edit start address and end address. See Figure 4-63. System can check the IP address validity after the edit operation and implement IPv6 optimization.
 - Default: Click it to restore default setup. In this case, the trusted sites and blocked sites are both null.

Note:

- If you enabled trusted sites, only the IP in the trusted sites list can access the device.
- If you enabled blocked sites, the IP in the blocked sites can not access the device.
- System supports add MAC address.



Figure 4-62

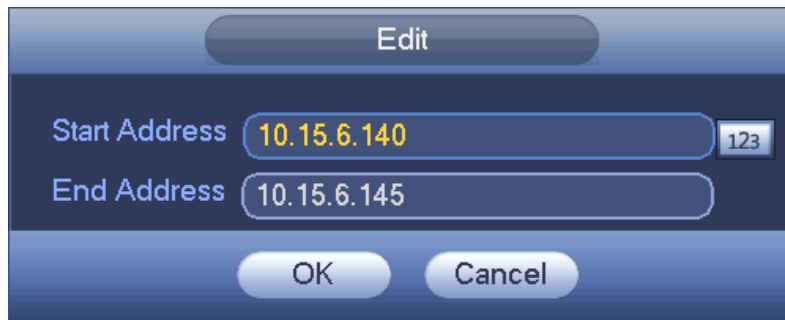

Figure 4-63

4.10.2.8 Email

The email interface is shown as below. See Figure 4-64.

- SMTP server: Please input your email SMTP server IP here.
- Port: Please input corresponding port value here.
- User name: Please input the user name to login the sender email box.
- Password: Please input the corresponding password here.
- Sender: Please input sender email box here.
- Title: Please input email subject here. System support English character and Arabic number. Max 32-digit.
- Receiver: Please input receiver email address here. System max supports 3 email boxes. System automatically filters same addresses if you input one receiver repeatedly.
- SSL enable: System supports SSL encryption box.
- Interval: The send interval ranges from 0 to 3600 seconds. 0 means there is no interval.
- Health email enable: Please check the box here to enable this function. This function allows the system to send out the test email to check the connection is OK or not.
- Interval: Please check the above box to enable this function and then set the corresponding interval. System can send out the email regularly as you set here. Click the Test button, you can see the corresponding dialogue box to see the email connection is OK or not.

Please note system will not send out the email immediately when the alarm occurs. When the alarm, motion detection or the abnormality event activates the email, system sends out the email according to the interval you specified here. This function is very useful when there are too many emails activated by the abnormality events, which may result in heavy load for the email server.



Figure 4-64

4.10.2.9 FTP

You need to download or buy FTP service tool (such as Ser-U FTP SERVER) to establish FTP service.

Please install Ser-U FTP SERVER first. From “start” -> “program” -> Serv-U FTP Server -> Serv-U Administrator. Now you can set user password and FTP folder. Please note you need to grant write right to FTP upload user. See Figure 4-65.

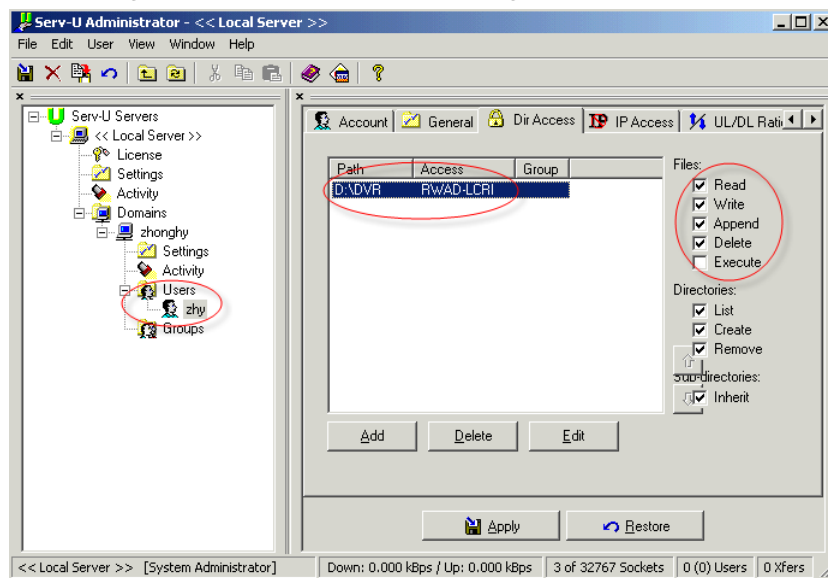

Figure 4-65

You can use a PC or FTP login tool to test setup is right or not.

For example, you can login user ZHY to [FTP://10.10.7.7](ftp://10.10.7.7) and then test it can modify or delete folder or not. See Figure 4-66.

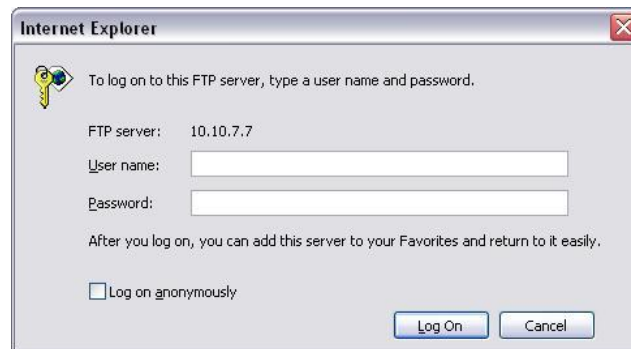

Figure 4-66

System also supports upload multiple DVRs to one FTP server. You can create multiple folders under this FTP.

FTP interface is shown as in Figure 4-67.

Please highlight the icon  in front of Enable to activate FTP function.

Here you can input FTP server address, port and remote directory. When remote directory is null, system automatically create folders according to the IP, time and channel.

User name and password is the account information for you to login the FTP.

File length is upload file length. When setup is larger than the actual file length, system will upload the whole file. When setup here is smaller than the actual file length, system only uploads the set length and auto ignore the left section. When interval value is 0, system uploads all corresponding files.

After completed channel and weekday setup, you can set two periods for one each channel.

Click the Test button, you can see the corresponding dialogue box to see the FTP connection is OK or not.



Figure 4-67

4.10.2.10 UPnP

The UPNP protocol is to establish a mapping relationship between the LAN and the WAN. Please input the router IP address in the LAN in Figure 4-55. See Figure 4-68.

- UPNP on/off : Turn on or off the UPNP function of the device.
- Status: When the UPNP is offline, it shows as “Unknown”. When the UPNP works it shows “Success”
- Router LAN IP: It is the router IP in the LAN.
- WAN IP: It is the router IP in the WAN.
- Port Mapping list: The port mapping list here is the one to one relationship with the router’s port mapping setting.
- List:
 - ✧ Service name: Defined by user.
 - ✧ Protocol: Protocol type
 - ✧ Internal port: Port that has been mapped in the router.
 - ✧ External port: Port that has been mapped locally.
- Default: UPNP default port setting is the HTTP, TCP and UDP of the DVR.
- Add to the list: Click it to add the mapping relationship.
- Delete: Click it to remove one mapping item.

Double click one item; you can change the corresponding mapping information. See Figure 4-69.

Important:

When you are setting the router external port, please use 1024~5000 port. Do not use well-known port 1~255 and the system port 256~1023 to avoid conflict.

For the TCP and UDP, please make sure the internal port and external port are the

same to guarantee the proper data transmission.



Figure 4-68



Figure 4-69

4.10.2.11 SNMP

SNMP is an abbreviation of Simple Network Management Protocol. It provides the basic network management frame of the network management system. The SNMP widely used in many environments. It is used in many network device, software and system. You can set in the following interface. See Figure 4-70.



Figure 4-70

Please enable the SNMP function. Use the corresponding software tool (MIB Builder and MG-SOFT MIB Browser). You still need two MIB file: BASE-SNMP-MIB, DVR-SNMP-MIB) to connect to the device. You can get the device corresponding configuration information after successfully connection.

Please follow the steps listed below to configure.

- In Figure 4-70, check the box to enable the SNMP function. Input the IP address of the PC than is running the software in the Trap address. You can use default setup for the rest items.
- Compile the above mentioned two MIB file via the software MIB Builder.
- Run MG-SOFT MIB Browser to load the file from the previous step to the software.
- Input the device IP you want to manage in the MG-SOFT MIB Browser. Please set the corresponding version for your future reference.
- Open the tree list on the MG-SOFT MIB Browser; you can get the device configuration. Here you can see the device has how many video channels, audio channels, application version and etc.

Note

Port conflict occurs when SNMP port and Trap port are the same.

4.10.2.12 Multicast

Multicast setup interface is shown as in Figure 4-71.

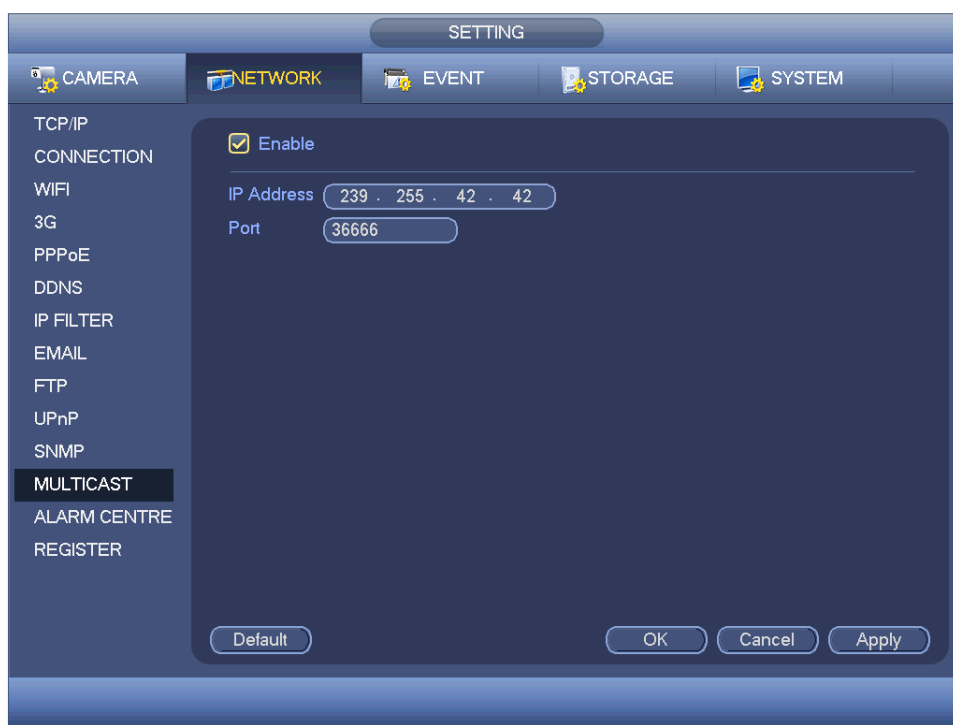

Figure 4-71

Here you can set a multiple cast group. Please refer to the following sheet for detailed information.

- IP multiple cast group address

-224.0.0.0-239.255.255.255

-“D” address space

- The higher four-bit of the first byte=“1110”

- Reserved local multiple cast group address

-224.0.0.0-224.0.0.255

-TTL=1 When sending out telegraph

-For example

224.0.0.1 All systems in the sub-net

224.0.0.2 All routers in the sub-net

224.0.0.4 DVMRP router

224.0.0.5 OSPF router

224.0.0.13 PIMv2 router

- Administrative scoped addressees

-239.0.0.0-239.255.255.255

-Private address space

- Like the single broadcast address of RFC1918
- Can not be used in Internet transmission
- Used for multiple cast broadcast in limited space.

Except the above mentioned addresses of special meaning, you can use other addresses.

For example:

Multiple cast IP: 235.8.8.36

Multiple cast PORT: 3666.

After you logged in the Web, the Web can automatically get multiple cast address and add it to the multiple cast groups. You can enable real-time monitor function to view the view. Please note multiple cast function applies to special series only.

4.10.2.13 Alarm Centre

This interface is reserved for you to develop. See Figure 4-72.



Figure 4-72

4.10.2.14 Auto register

This function allows the device to auto register to the proxy you specified. In this way, you can use the client-end to access the DVR and etc via the proxy. Here the proxy has a switch function. In the network service, device supports the server address of IPv4 or domain.

Please follow the steps listed below to use this function.

Please set proxy server address, port, and sub-device name at the device-end. Please enable the auto register function, the device can auto register to the proxy server.

1) The setup interface is shown as in Figure 4-73.

Important

Do not input network default port such as TCP port number.



Figure 4-73

2) The proxy server software developed from the SDK. Please open the software and input the global setup. Please make sure the auto connection port here is the same as the port you set in the previous step.

3) Now you can add device. Please do not input default port number such as the TCP port in the mapping port number. The device ID here shall be the same with the ID you input in Figure 4-73. Click Add button to complete the setup.

4) Now you can boot up the proxy server. When you see the network status is Y, it means your registration is OK. You can view the proxy server when the device is online.

Important

The server IP address can also be domain. But you need to register a domain name before you run proxy device server.

4.10.3 Event

4.10.3.1 Detect





In the main menu, from Setting->Event->Detect, you can see motion detect interface. See Figure 4-74. There is three detection types: motion detection, video loss, tampering.

- The video loss has no detection region and sensitivity setup and tampering has no detection region setup.
- You can see motion detect icon if current channel has enabled motion detect alarm.
- You can drag you mouse to set motion detect region. Please click OK button to save current region setup. Right click mouse to exit current interface.

4.10.3.1.1 Motion Detect

After analysis video, system can generate a video loss alarm when the detected moving signal reached the sensitivity you set here.

Detection menu is shown as below. See Figure 4-74.

- Event type: From the dropdown list you can select motion detection type.
- Channel: Select a channel from the dropdown list to set motion detect function.
- Enable: Check the box here to enable motion detect function.
- Region: Click select button, the interface is shown as in Figure 4-75. Here you can set motion detection zone. There are four zones for you to set. Please select a zone first and then left drag the mouse to select a zone. The corresponding color zone displays different detection zone. You can click Fn button to switch between the arm mode and disarm mode. In arm mode, you can click the direction buttons to move the green rectangle to set the motion detection zone. After you completed the setup, please click ENTER button to exit current setup. Do remember click save button to save current setup. If you click ESC button to exit the region setup interface system will not save your zone setup.
- Sensitivity: System supports 6 levels. The sixth level has the highest sensitivity.
- Anti-dither: Here you can set anti-dither time. The value ranges from 5 to 600s. The anti-dither time refers to the alarm signal lasts time. It can be seen as the alarm signal activation stays such as the buzzer, tour, PTZ activation, snapshot, channel record. The stay time here does not include the latch time. During the alarm process, the alarm signal can begin an anti-dither time if system detects the local alarm again. The screen prompt, alarm upload, email and etc will not be activated. For example, if you set the anti-dither time as 10 second, you can see the each activation may last 10s if the local alarm is activated. During the process, if system detects another local alarm signal at the fifth second, the buzzer, tour, PTZ activation, snapshot, record channel will begin another 10s while the screen prompt, alarm upload, email will not be activated again. After 10s, if system detects another alarm signal, it can generate an alarm since the anti-dither time is out.
- Period: Click set button, you can see an interface is shown as in Figure 4-77. Here you can set motion detect period. System only enables motion detect operation in the specified periods. It is not for video loss or the tampering. There are two ways for you to set periods. Please note system only supports 6 periods in one day.
 - ◇ In Figure 4-77, Select icon  of several dates, all checked items can be edited together. Now the icon is shown as . Click  to delete a record type from one period.
 - ◇ In Figure 4-77. Click button  after one date or a holiday, you can see an interface shown as in Figure 4-78. There are four record types: regular, motion detection (MD), Alarm, MD & alarm.
- Alarm output: when an alarm occurs, system enables peripheral alarm devices.

- Latch: when motion detection complete, system auto delays detecting for a specified time. The value ranges from 1-300(Unit: second)
- Show message: System can pop up a message to alarm you in the local host screen if you enabled this function.
- Alarm upload: System can upload the alarm signal to the network (including alarm centre) if you enabled current function.
- Send email: System can send out email to alert you when an alarm occurs.
- Record channel: System auto activates motion detection channel(s) to record once an alarm occurs. Please make sure you have set MD record in Schedule interface(Main Menu->Setting->Schedule) and schedule record in manual record interface(Main Menu->Advanced->Manual Record)
- PTZ activation: Here you can set PTZ movement when an alarm occurs. Such as go to preset, tour & pattern when there is an alarm. Click “select” button, you can see an interface is shown as in Figure 4-76.
- Record Delay: System can delay the record for specified time after alarm ended. The value ranges from 10s to 300s.
- Tour: Here you can enable tour function when alarm occurs. System one-window tour.
- Snapshot: You can enable this function to snapshot image when a motion detect alarm occurs.
- Video matrix Check the box here to enable this function. When an alarm occurs, SPOT OUT port displays device video output. It displays video (1-window tour) from alarm activation channel you select at the Record channel item.
- Buzzer: Highlight the icon to enable this function. The buzzer beeps when alarm occurs.
- Test: Click it to test current motion detect setup (do not need to save). Click Select button after Region, you can set motion detect area.

Please highlight icon  to select the corresponding function. After all the setups please click save button, system goes back to the previous menu.

Note:

In motion detection mode, you can not use copy/paste to set channel setup since the video in each channel may not be the same.

In Figure 4-75, you can left click mouse and then drag it to set a region for motion detection. Click Fn to switch between arm/withdraw motion detection. After setting, click enter button to exit.



Figure 4-74

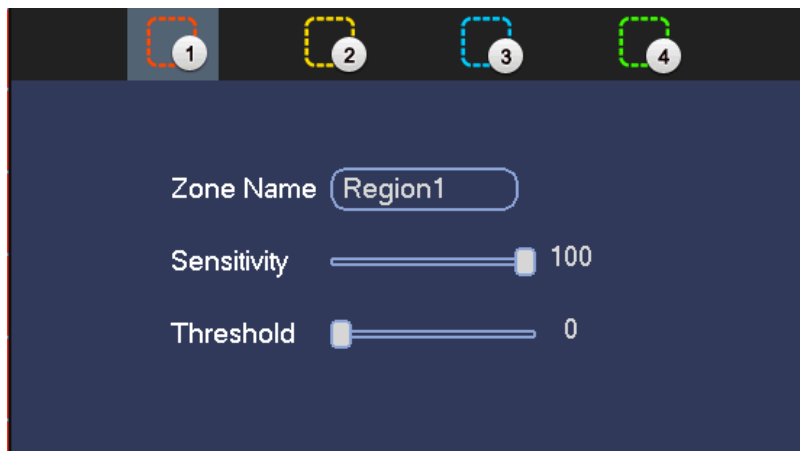

Figure 4-75

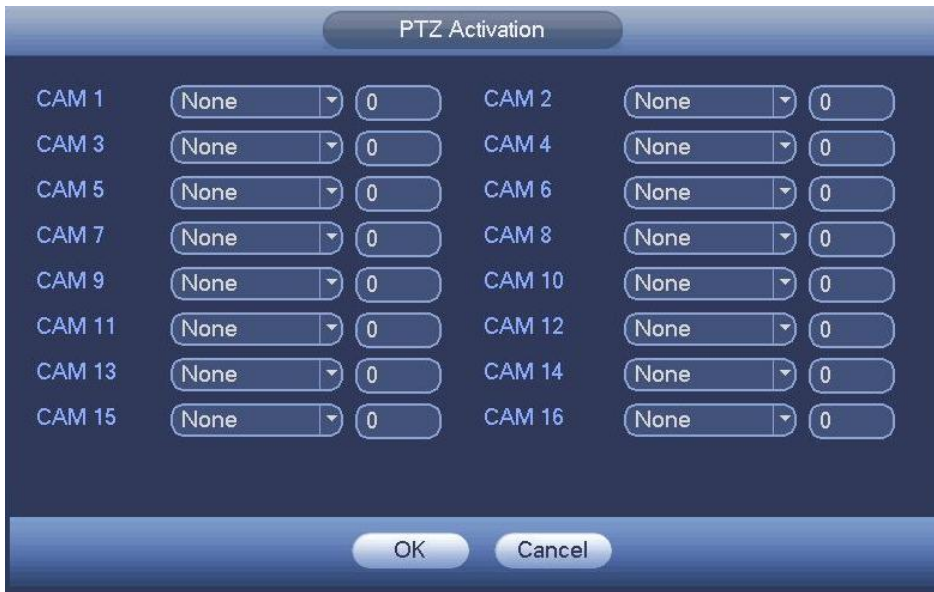

Figure 4-76

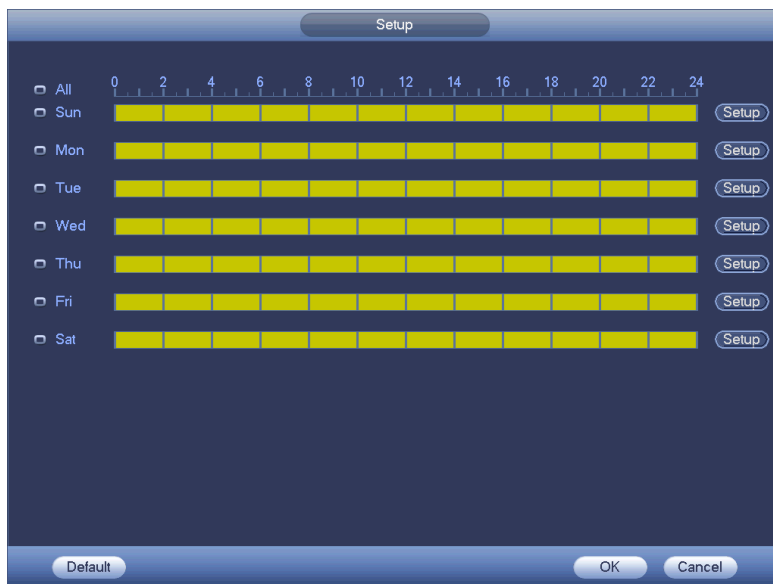

Figure 4-77



Figure 4-78

Motion detect here only has relationship with the sensitivity and region setup. It has no relationship with other setups.

4.10.3.1.2 Video Loss

In Figure 4-74, select video loss from the type list. You can see the interface is shown as in Figure 4-79. This function allows you to be informed when video loss phenomenon occurred. You can enable alarm output channel and then enable show message function.

Tips:

You can enable preset/tour/pattern activation operation when video loss occurs. Please refer to chapter 4.10.3.1.1 motion detection for detailed information.



Figure 4-79

4.10.3.1.3 Tampering

When someone viciously masks the lens, or the output video is in one-color due to the environments light change, the system can alert you to guarantee video continuity. Tampering interface is shown as in Figure 4-80. You can enable “Alarm output “or “Show message” function when tampering alarm occurs.

- Sensitivity: The value ranges from 1 to 6. It mainly concerns the brightness. The level 6 has the higher sensitivity than level 1. The default setup is 3.

Tips:

You can enable preset/tour/pattern activation operation when video loss occurs. Please refer to chapter 4.10.3.1.1 motion detection for detailed information.

Note:

- In Detect interface, copy/paste function is only valid for the same type, which means you can not copy a channel setup in video loss mode to tampering mode.
- About Default function. Since detection channel and detection type may not be the same, system can only restore default setup of current detect type. For example, if you click Default button at the tampering interface, you can only restore default tampering setup. It is null for other detect types.
- System only enables tampering function during the period you set here. It is null for motion detect or video loss type.



Figure 4-80



4.10.3.2 Alarm

Before operation, please make sure you have properly connected alarm devices such as buzzer.

In the main menu, from Setting->Event->Alarm, you can see alarm setup interface. See Figure 4-81.

There are two alarm types. See Figure 4-81 to Figure 4-82.

- Local alarm: The alarm signal system detects from the alarm input port.
- Network alarm: It is the alarm signal from the network.
- Alarm in: Here is for you to select channel number.
- Type: normal open or normal close.
- PTZ activation: Here you can set PTZ movement when alarm occurs. Such as go to preset, tour & pattern when there is an alarm. Click "select" button, you can see an interface is shown as in Figure 4-83.
- Period: Click set button, you can see an interface is shown as in Figure 4-84. There are two ways for you to set periods. There are max 6 periods in one day. There are four record types: regular, motion detection (MD), Alarm, MD & alarm.

✧ In Figure 4-84, Select icon  of several dates, all checked items can be edited together. Now the icon is shown as . Click  to delete a record type from one period.

✧ In Figure 4-84. Click button  after one date or a holiday, you can see an interface shown as in Figure 4-85. There are four record types: regular, motion detection (MD), Alarm, MD & alarm.

- Anti-dither: Here you can set anti-dither time. Here you can set anti-dither time. The value ranges from 5 to 600s. The anti-dither time refers to the alarm signal lasts time. It can be seem as the alarm signal activation stays such as the buzzer, tour, PTZ activation, snapshot, channel record. The stay time here does not include the latch time. During the alarm process, the alarm signal can begin an anti-dither time if system detects the local alarm again. The screen prompt, alarm upload, email and etc will not be activated. For example, if you set the anti-dither time as 10 second, you can see the each activation may last 10s if the local alarm is activated. During the process, if system detects another local alarm signal at the fifth second, the buzzer, tour, PTZ activation, snapshot, record channel will begin another 10s while the screen prompt, alarm upload, email will not be activated again. After 10s, if system detects another alarm signal, it can generate an alarm since the anti-dither time is out.
- Show message: System can pop up a message to alarm you in the local host screen if you enabled this function.
- Alarm upload: System can upload the alarm signal to the network (including alarm centre) if you enabled current function.
- Send email: System can send out email to alert you when alarm occurs.
- Record channel: you can select proper channel to record alarm video (Multiple choices). At the same time you need to set alarm record in schedule interface (Main Menu->Setting->Schedule) and select schedule record in manual record interface (Main Menu->Advance->Manual Record).
- Latch: Here is for you to set proper delay duration. Value ranges from 10 to 300 seconds. System automatically delays specified seconds in turning off alarm and activated output after external alarm cancelled.
- Tour: Here you can enable tour function when alarm occurs. System supports 1/8-window tour. Please note the tour setup here has higher priority than the tour setup you set in the Display interface. Once there two tours are both enabled, system can enable the alarm tour as you set here when an alarm occurred. If there is no alarm, system implements the tour setup in the Display interface.
- Snapshot: System can snapshot corresponding channel when an alarm occurs. Please note the activation snapshot has the higher priority than schedule snapshot. If you have enabled these two types at the same time, system can activate the activation snapshot when alarm occurs, and otherwise system just operates the schedule snapshot.
- Video matrix: Check the box here to enable this function. When an alarm occurs, SPOT OUT port displays device video output. It displays video (1-window tour) from alarm activation channel you select at the Record channel item.
- Buzzer: Highlight the icon to enable this function. The buzzer beeps when alarm occurs.

Please note, network alarm means the alarm signal from the TCP/IP. You can use NET SDK to activate network alarm. Comparing with the local alarm, there is no type, anti-dither, alarm upload function.

Please highlight icon  to select the corresponding function. After setting all the

setups please click save button, system goes back to the previous menu.



Figure 4-81



Figure 4-82

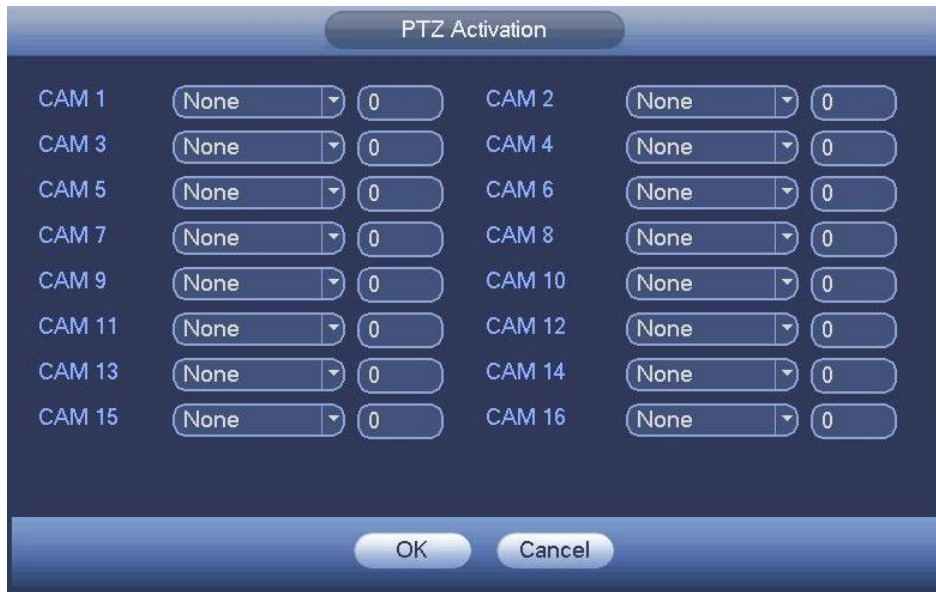

Figure 4-83

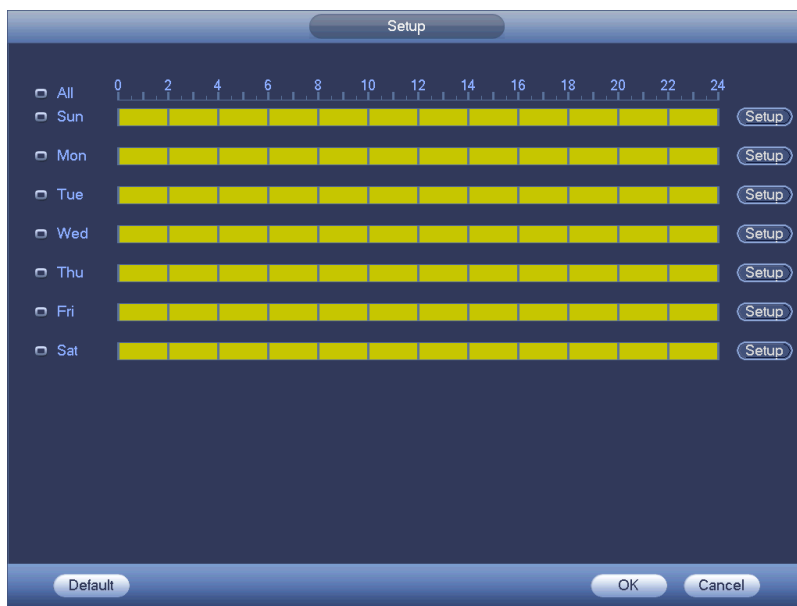

Figure 4-84



Figure 4-85

4.10.3.3 Abnormality

There are two types: HDD/Network.

- ✧ HDD: HDD error, no disk, no space. See Figure 4-86 and Figure 4-87.
- ✧ Network: Disconnection, IP conflict, MAC conflict. See Figure 4-88.
- Alarm output: Please select alarm activation output port (multiple choices).
- Less than: System can alarm you when the HDD space is less than the threshold you set here (For HDD no space type only).
- Latch: Here you can set corresponding delaying time. The value ranges from 1s-300s. System automatically delays specified seconds in turning off alarm and activated output after external alarm cancelled.
- Show message: system can pop up the message in the local screen to alert you when alarm occurs.
- Alarm upload: System can upload the alarm signal to the network (including alarm centre) if you enabled current function. For disconnection event, IP conflict event and MAC conflict event, this function is null.
- Send email: System can send out email to alert you when alarm occurs.
- Buzzer: Highlight the icon to enable this function. The buzzer beeps when alarm occurs.

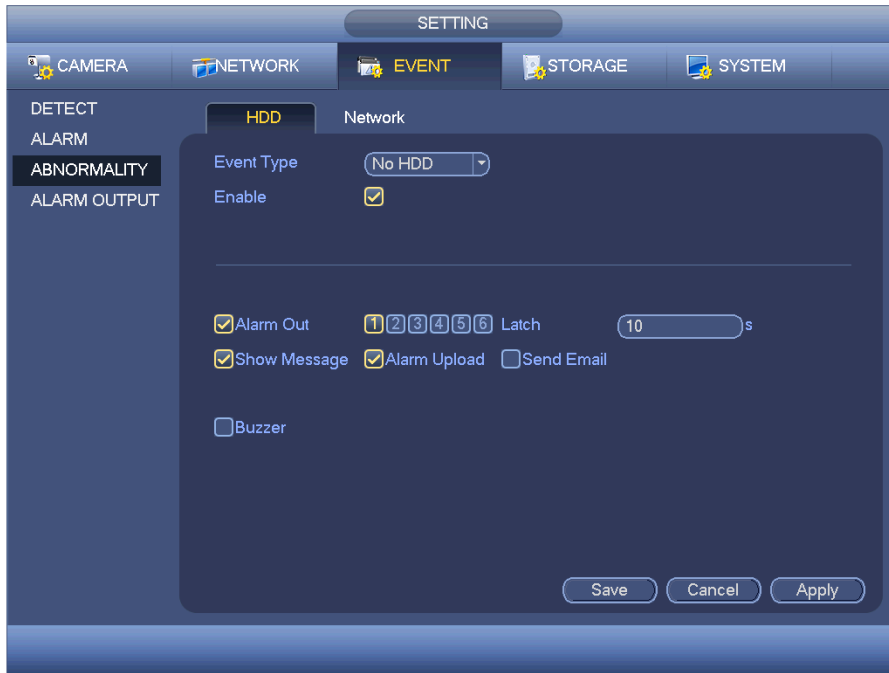

Figure 4-86



Figure 4-87



Figure 4-88

4.10.3.4 Alarm Output

Here is for you to set proper alarm output such as schedule, manual.

Please highlight icon  to select the corresponding alarm output.

After all the setups please click OK button, system goes back to the previous menu. See Figure 4-89.



Figure 4-89

4.10.4 Storage

4.10.4.1 Schedule

4.10.4.1.1 Record

Note:



You need to have proper rights to implement the following operations. Please make sure the HDDs have been properly installed.

After the system booted up, it is in default 24-hour regular mode. You can set record type and time in schedule interface.

In the main menu, from Setting->Storage->Schedule, you can go to schedule menu. See Figure 4-93.

Please note you need to go to main menu->Setting->System->General->Holiday to set holiday date first, otherwise, there is no holiday setup item.

- Channel: Please select the channel number first. You can select “all” if you want to set for the whole channels.

✧ : Sync connection icon. Select icon  of several dates, all checked items can be edited together. Now the icon is shown as .

✧ : Click it to delete a record type from one period.

- Record Type: Please check the box to select corresponding record type. There are four types: Regular/MD (motion detect)/Alarm/MD&Alarm.
- Week day: There are eight options: ranges from Saturday to Sunday and all.
- Holiday: It is to set holiday setup. Please note you need to go to the General interface (Main Menu->System->General) to add holiday first. Otherwise you can not see this item.
- Pre-record: System can pre-record the video before the event occurs into the file. The value ranges from 1 to 30 seconds depending on the bit stream.
- Redundancy: System supports redundancy backup function. You can highlight Redundancy button to activate this function. Please note, before enable this function, please set at least one HDD as redundant. (Main menu->Setting->Storage->HDD Manager). **Please note this function is null if there is only one HDD.**
- Period setup: Click button  after one date or a holiday, you can see an interface shown as in Figure 4-94. There are four record types: regular, motion detection (MD), Alarm, MD & alarm.

Please following the steps listed below to draw the period manually.

- ✧ Select a channel you want to set. See Figure 4-90.



Figure 4-90

- ✧ Set record type. See Figure 4-91.



Figure 4-91

- ✧ Please draw manually to set record period. There are six periods in one day. See Figure 4-92.

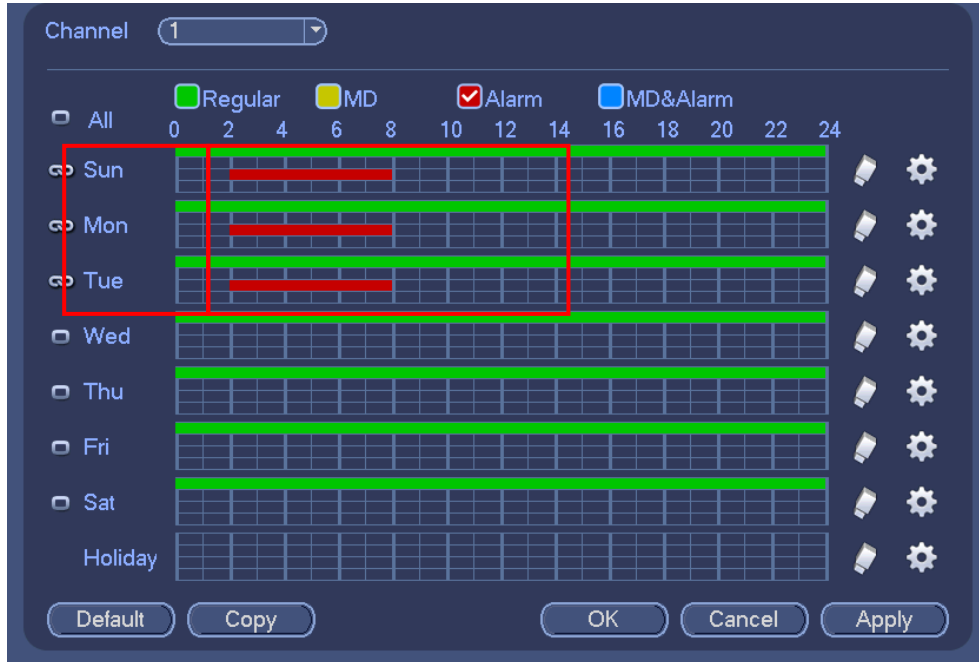



Figure 4-92

Please highlight icon  to select the corresponding function. After completing all the setups please click save button, system goes back to the previous menu.

There are color bars for your reference. Green color stands for regular recording, yellow color stands for motion detection and red color stands for alarm recording. The white means the MD and alarm record is valid. Once you have set to record when the MD and alarm occurs, system will not record neither motion detect occurs nor the alarm occurs.

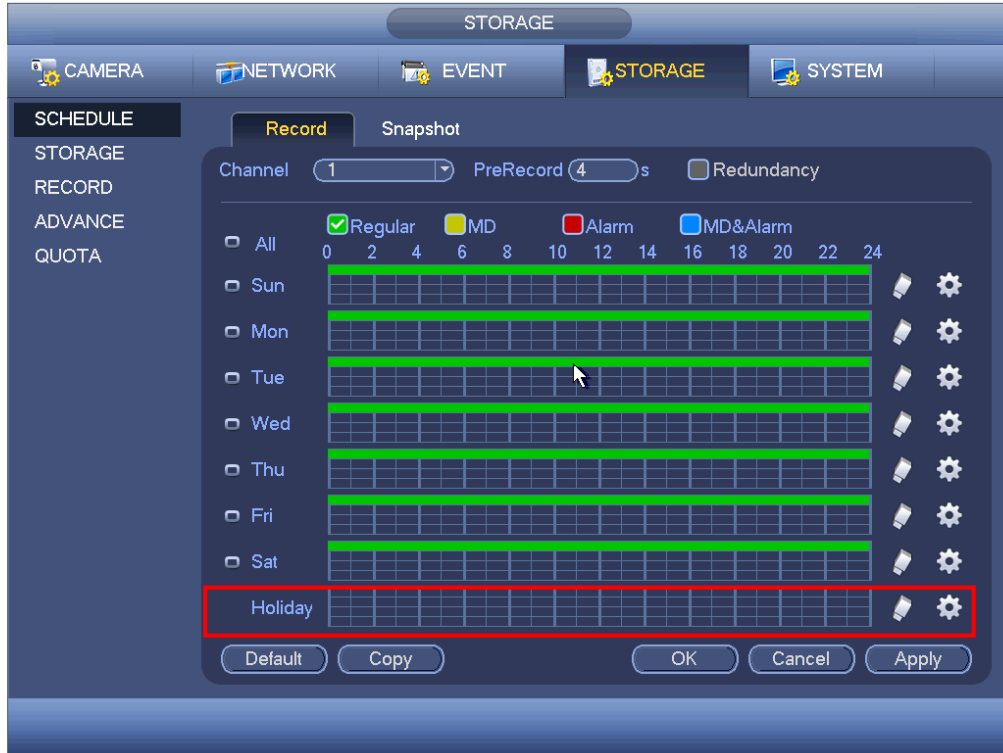

Figure 4-93

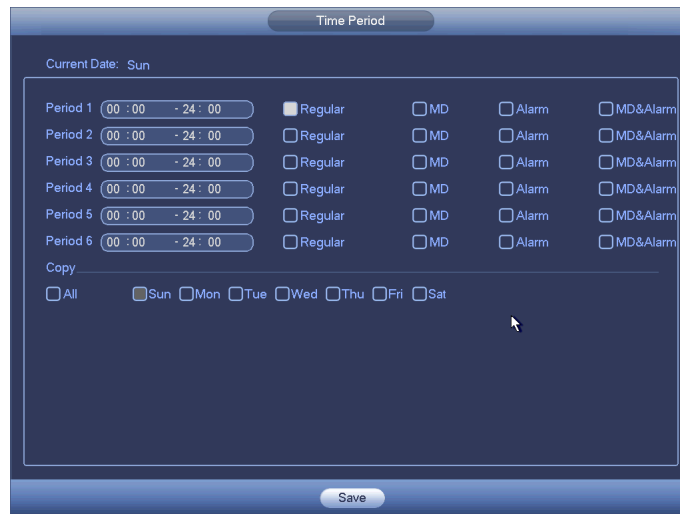

Figure 4-94

4.10.4.1.1.1 Quick Setup

Copy function allows you to copy one channel setup to another. After setting in channel 1, click Copy button, you can go to interface Figure 4-95. You can see current channel name is grey such as channel 1. Now you can select the channel you want to paste such as channel 5/6/7. If you want to save current setup of channel 1 to all channels, you can click the first box “ALL”. Click the OK button to save current copy setup. Click the OK button in the Encode interface, the copy function succeeded.

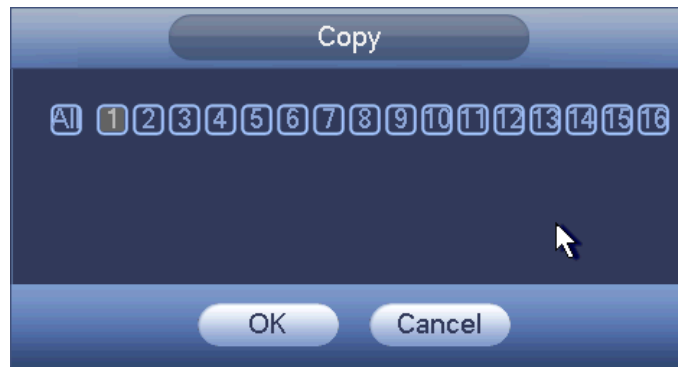

Figure 4-95

4.10.4.1.1.2 Redundancy

Redundancy function allows you to memorize record file in several disks. When there is file damage occurred in one disk, there is a spare one in the other disk. You can use this function to maintain data reliability and safety.

- In the main menu, from Setting->Storage-> Schedule, you can highlight redundancy button to enable this function.
- In the main menu, from Main menu->Setting->Storage->HDD Manager, you can set one or more disk(s) as redundant. You can select from the dropdown list. System auto overwrites old files once hard disk is full.

Please note only read/write disk or read-only disk can backup file and support file search function, so you need to set at least one read-write disk otherwise you can not record video.

Note

About redundancy setup:

- If current channel is not recording, current setup gets activated when the channel begin recording the next time.
- If current channel is recording now, current setup will get activated right away, the current file will be packet and form a file, then system begins recording as you have just set.

After all the setups please click save button, system goes back to the previous menu.

Playback or search in the redundant disk.

There are two ways for you to playback or search in the redundant disk.

- Set redundant disk(s) as read-only disk or read-write disk (Main menu->Setting->Storage->HDD Manager)). System needs to reboot to get setup activated. Now you can search or playback file in redundant disk.
- Dismantle the disk and play it in another PC.

4.10.4.1.2 Snapshot

4.10.4.1.2.1 Schedule Snapshot

- On the preview interface, right click mouse and then select Manual->Record, or in the main menu, from Setting->Storage->Record, check the box to enable snapshot function of corresponding channels. See Figure 4-96.

- In main menu, from Setting->Camera->Encode->Snapshot interface, here you can input snapshot mode as regular, size, quality and frequency. See Figure 4-97.
 - In main menu, from Setting->Camera->Encode->Schedule interface, please enable snapshot function. See interface on the right of Figure 4-98.
- Please refer to the following figure for detailed information.

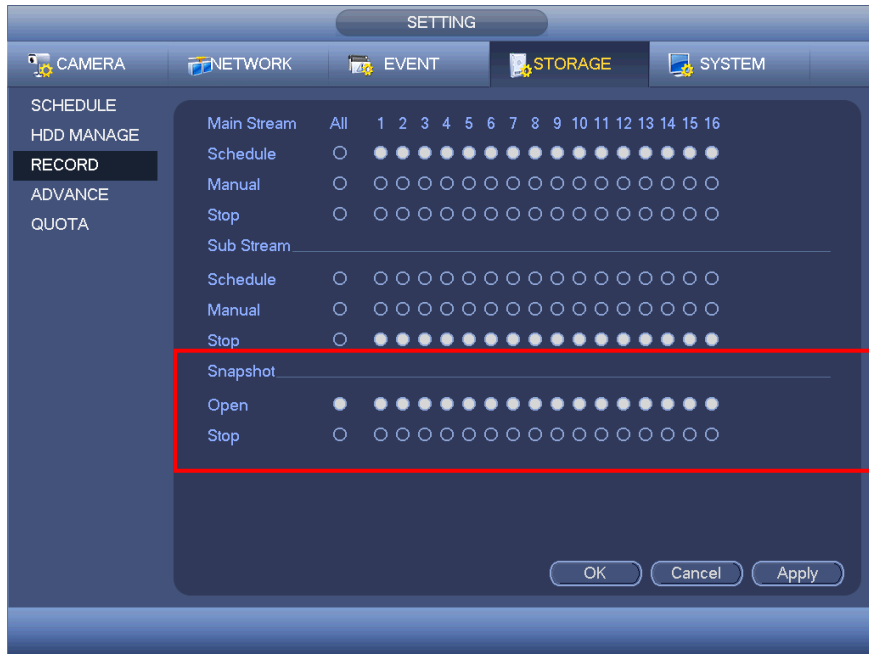

Figure 4-96

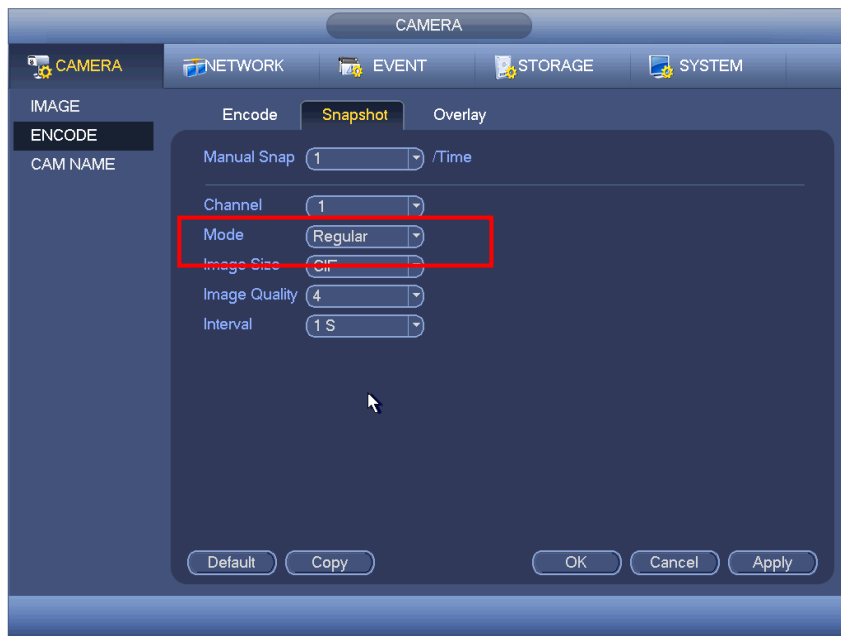

Figure 4-97

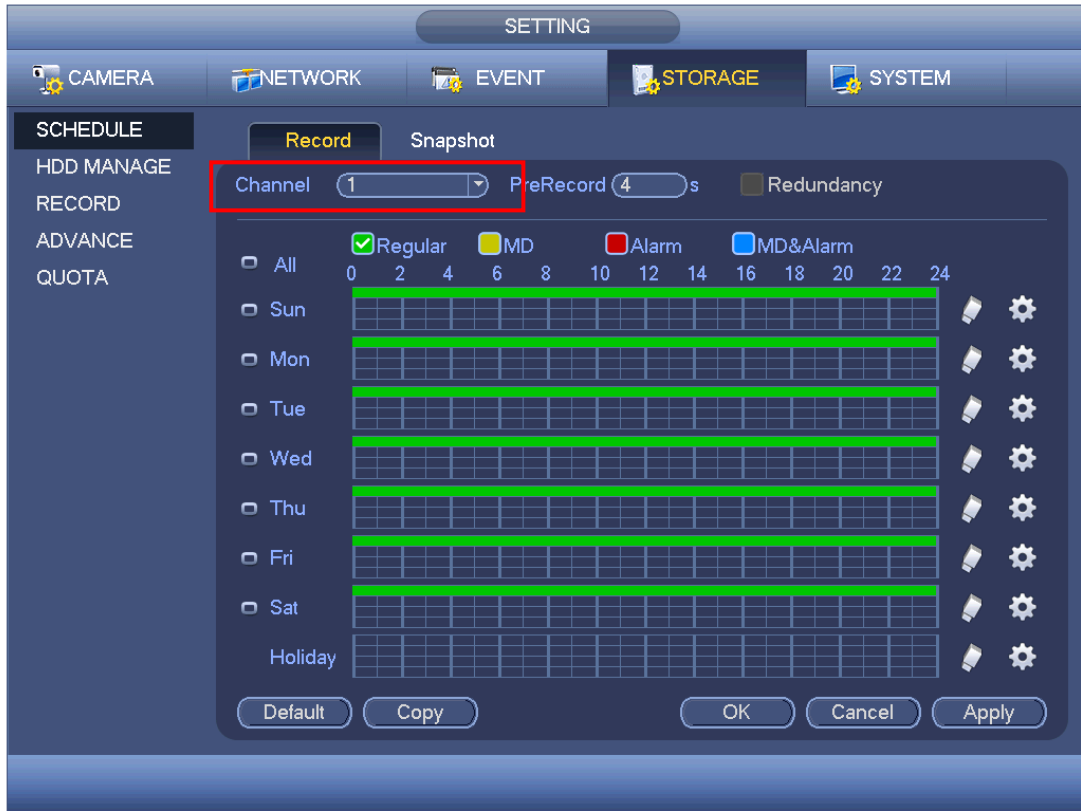

Figure 4-98

4.10.4.1.2.2 Trigger Snapshot

Please follow the steps listed below to enable the activation snapshot function. After you enabled this function, system can snapshot when the corresponding alarm occurred.

- In main menu, from Setting->Camera->Encode->Snapshot interface, here you can input snapshot mode as trigger, size, quality and frequency. See Figure 4-99.
- In main menu, from Setting->Event->Detect, please enable snapshot function for specified channels (Figure 4-100). Or In main menu, from Setting->Event->Alarm (Figure 4-101) please enable snapshot function for specified channels.

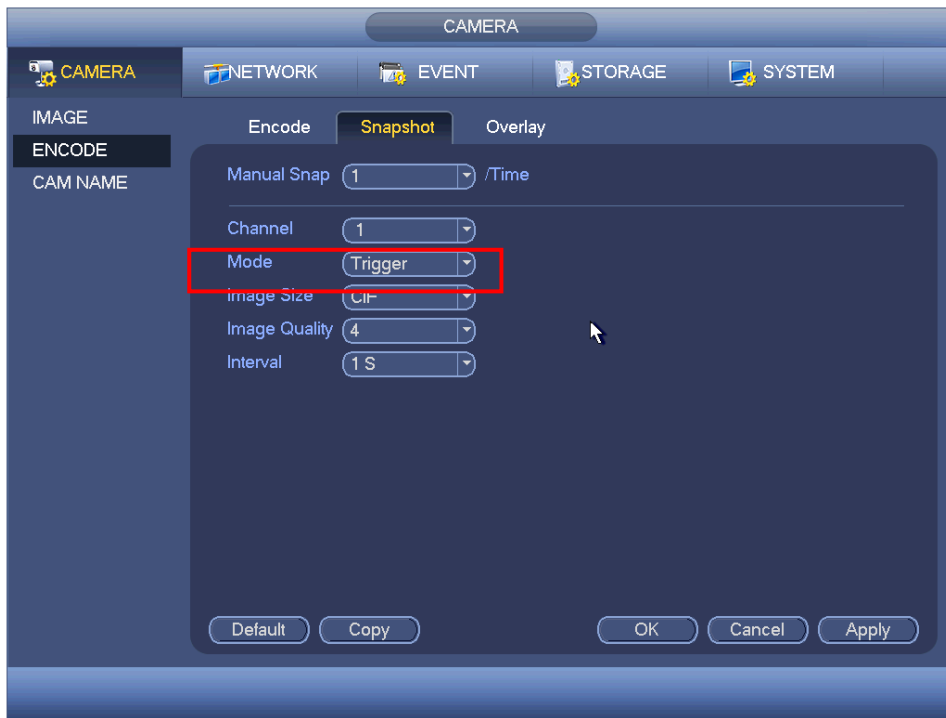

Figure 4-99

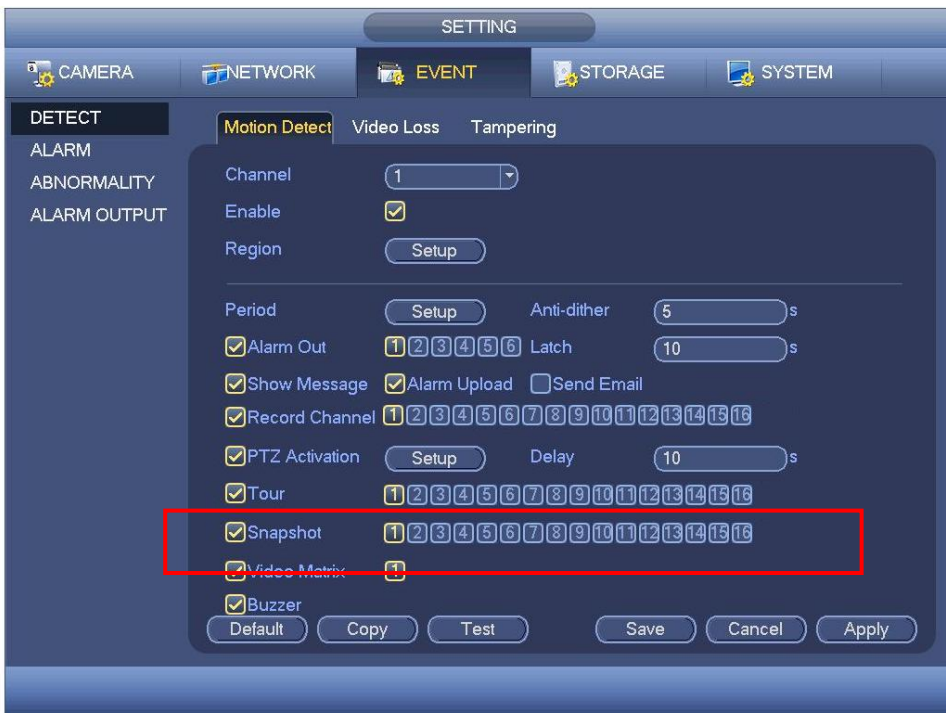

Figure 4-100

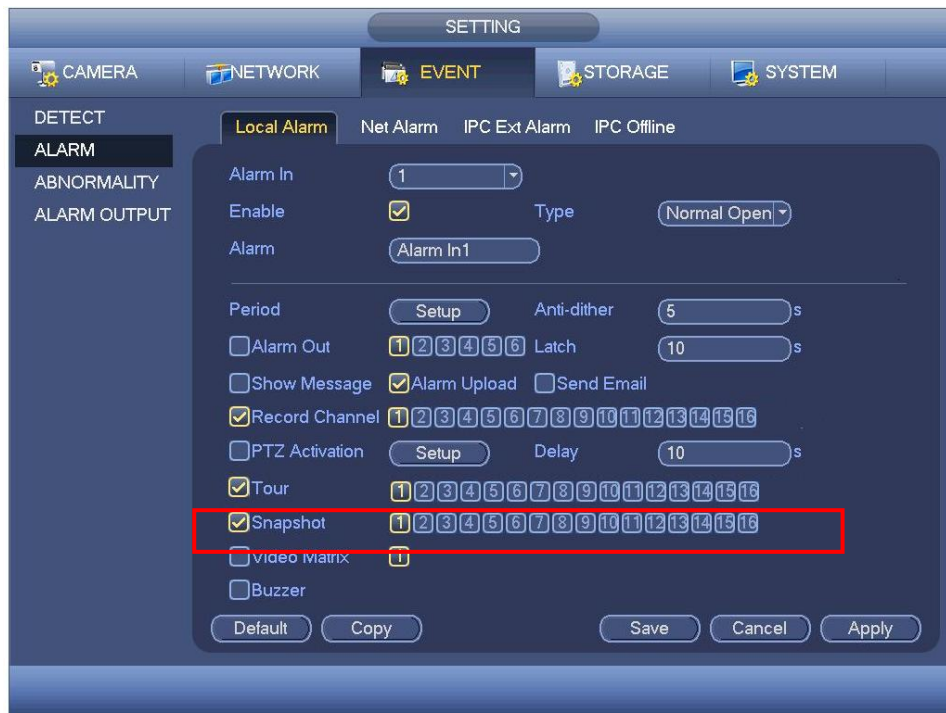

Figure 4-101

4.10.4.1.2.3 Priority

Please note the activation snapshot has the higher priority than schedule snapshot. If you have enabled these two types at the same time, system can activate the activation snapshot when alarm occurs, and otherwise system just operates the schedule snapshot.

4.10.4.1.2.4 Image FTP

In the main menu, from Setting->Network->FTP, you can set FTP server information. Please enable FTP function and then click save button. See Figure 4-102.

Please boot up corresponding FTP server.

Please enable schedule snapshot (Chapter 4.10.4.1.2.1) or activation snapshot (Chapter 4.10.4.1.2.2) first, now system can upload the image file to the FTP server.

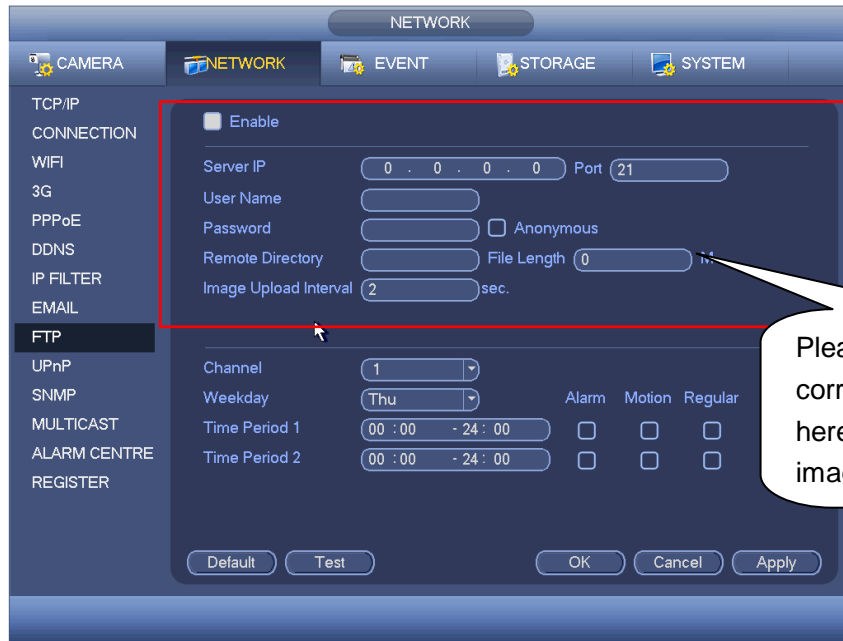

Figure 4-102

4.10.4.2 HDD Manager

Here is for you to view and implement hard disk management. See Figure 4-103. You can see current HDD type, status, capacity and etc. The operation includes format HDD, and change HDD property (read and write/read-only/redundancy).



Figure 4-103

4.10.4.3 Record

4.10.4.3.1 Record Control

Note:

You need to have proper rights to implement the following operations. Please make sure the HDD has been properly installed.

There are three ways for you to go to manual record menu.

- Right click mouse and then select Manual->Record.
- In the main menu, from Setting->Storage->Record.
- In live viewing mode, click record button in the front panel or record button in the remote control.

System supports main stream and sub stream. There are three statuses: schedule/manual/stop. See Figure 4-104. Please highlight icon “○” to select corresponding channel.

- Manual: The highest priority. After manual setup, all selected channels will begin ordinary recording.
- Schedule: Channel records as you have set in recording setup (Main Menu->Setting->System->>Schedule)
- Stop: Current channel stops recording.
- All: Check All button after the corresponding status to enable/disable all-channel schedule/manual record or enable/disable all channels to stop record.

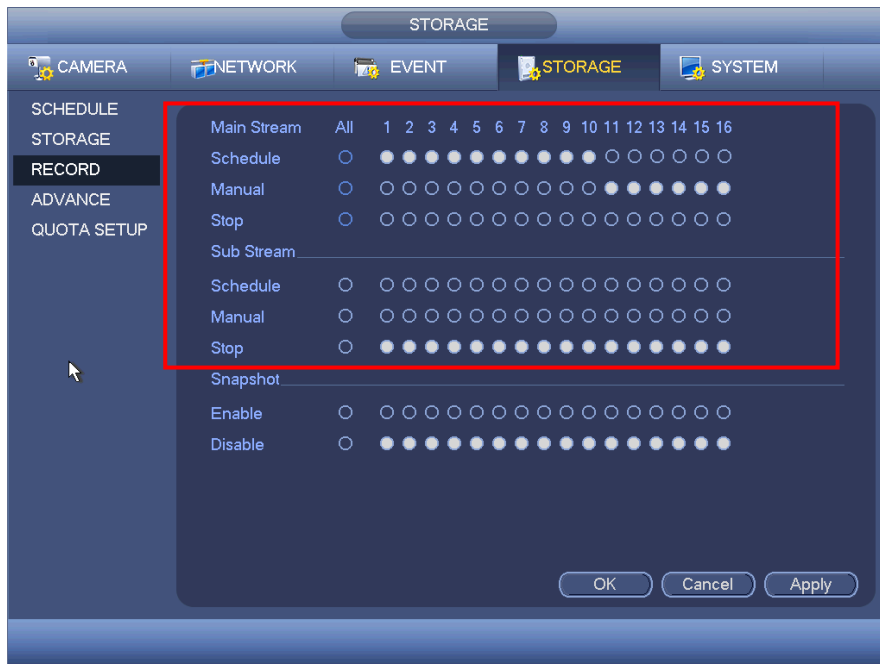

Figure 4-104

4.10.4.3.2 Snapshot Operation

Check the corresponding box to enable/disable schedule snapshot function. See Figure 4-105.

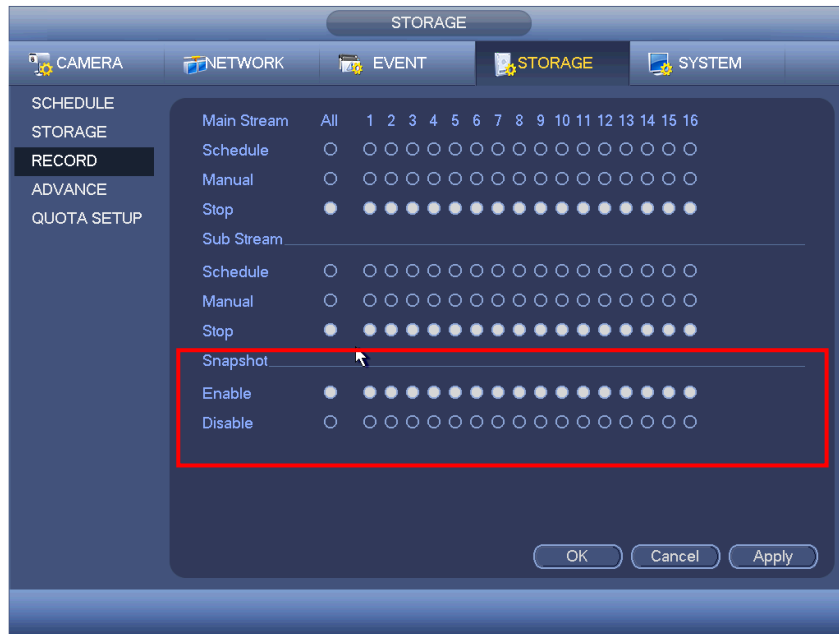

Figure 4-105

Tips

You can check All button after the corresponding status to enable/disable all-channel snapshot function.

4.10.5 System

4.10.5.1 General

4.10.5.1.1 Device

General setting includes the following items. See Figure 4-106.

- Device ID: Please input a corresponding device name here.
- Device No: Here you can set device number.
- Language: System supports various languages: Chinese (simplified), Chinese (Traditional), English, Italian, Japanese, French, Spanish (All languages listed here are optional. Slight difference maybe found in various series.)
- Video standard: There are two formats: NTSC and PAL.
- HDD full: Here is for you to select working mode when hard disk is full. There are two options: stop recording or rewrite. If current working HDD is overwritten or the current HDD is full while the next HDD is no empty, then system stops recording, If the current HDD is full and then next HDD is not empty, then system overwrites the previous files.
- Pack duration: Here is for you to specify record duration. The value ranges from 1 to 120 minutes. Default value is 60 minutes.
- Real-time playback: It is to set playback time you can view in the preview interface. The value ranges from 5 to 60 minutes.
- Auto logout: Here is for you to set auto logout interval once login user remains inactive for a specified time. Value ranges from 0 to 60 minutes.

- Navigation bar: Check the box here, system displays the navigation bar on the interface.
- Startup wizard: Once you check the box here, system will go to the startup wizard directly when the system restarts the next time. Otherwise, it will go to the login interface.
- Mouse property: You can set double click speed via dragging the slide bard. You can Click Default button to restore default setup.



Figure 4-106

4.10.5.1.2 Date and Time

The interface is shown as in Figure 4-107.

- Date format: There are three types: YYYY-MM-DD: MM-DD-YYYY or DD-MM-YYYY.
- Date separator: There are three denotations to separate date: dot, beeline and solidus.
- DST: Here you can set DST time and date. Here you can set start time and end time by setting corresponding week setup or by setting corresponding date setup.
- NTP: It is to set NTP server information.



Figure 4-107

4.10.5.1.3 Holiday

Holiday setup interface is shown as in Figure 4-108. Click Add new holiday button, you can input new holiday information. See Figure 4-109. Here you can set holiday name, repeat mode and start/end time.

Note

- When you enable Holiday settings and schedule setup at the same time, holiday setting has the priority. If the selected day is a holiday, then system records as you set in holiday setting. If it is not a holiday, system records as you set in Schedule interface. Please note
- Please note, there is no year setup on the holiday setup. For example, if you set 30th Oct, 2012 as a holiday, then the date of 30th Oct in each year will be set as a holiday.

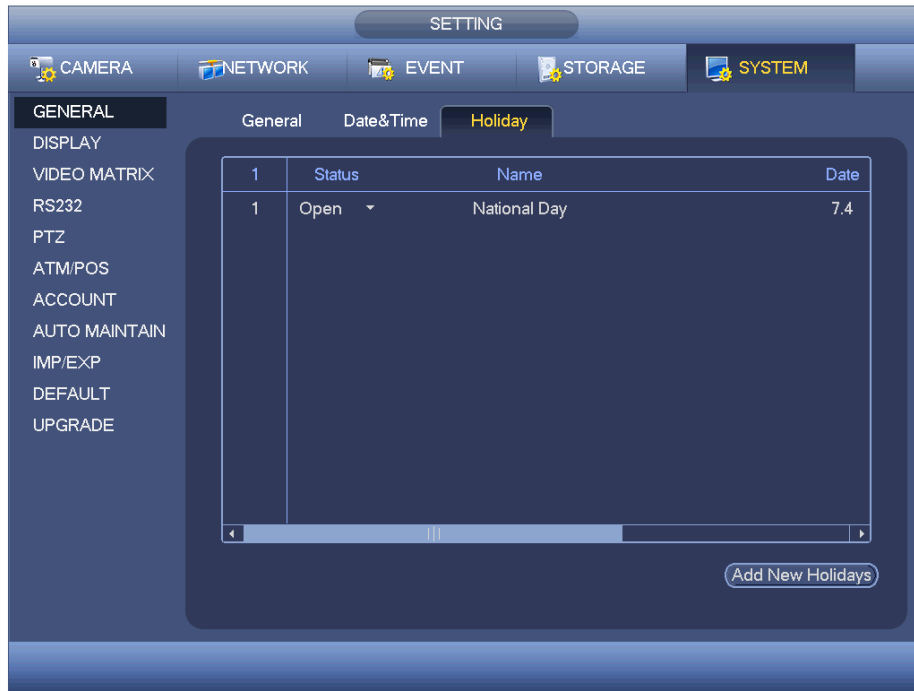

Figure 4-108



Figure 4-109

4.10.5.2 Display

4.10.5.2.1 Display

Display setup interface is shown as below. See Figure 4-110.

- Transparency: Here is for you to adjust transparency. The value ranges from 128 to 255.

- Channel name: Here is for you to modify channel name. System max support 25-digit (The value may vary due to different series). Please note all your modification here only applies to DVR local end. You need to open web or client end to refresh channel name.
- Time display: You can select to display time or not when system is playback.
- Channel display: You can select to channel name or not when system is playback.
- Resolution: There are four options: 1920×1080, 1280×1024(default),1280×720,1024×768. Please note the system needs to reboot to activate current setup.
- Image enhance: Check the box; you can optimize the margin of the preview video.
- Preview denoise: It is to reduce the video noise and make it clearer. You can set denoise level. The higher the level is, the clearer the video is.

Please highlight icon  to select the corresponding function.

After completing all the setups please click save button, system goes back to the previous menu.



Figure 4-110

4.10.5.2.2 TV Adjust

Here is for you to adjust TV output setup. See Figure 4-111.

Please drag slide bar to adjust each item.

After all the setups please click OK button, system goes back to the previous menu.



Figure 4-111



4.10.5.2.3 Tour

Here you can activate tour function. Click Setup button, you can see an interface shown as in Figure 4-112

- Enable tour: Highlight box here to enable this function.
- Interval: System supports 1/8/-window tour. Input proper interval value here. The value ranges from 5-120 seconds. It is for schedule tour/alarm/motion detect tour.
- Split: You can select window split mode from the dropdown list.
- Channel group: It is to display all channel groups on current split mode. You can edit and delete a channel group here. Double click an item in the list; you can edit its channel group setup. Right now system max supports 32.
- Add: Under specified window split mode, click it to add channel group.
- Delete: Click it to remove selected channel group.
- Move up: Click it to move current selected channel up.
- Move down: Click it to move current selected channel down.
- Default: Click it to restore default setup.

Tips:

- Use mouse or Shift button to switch  and  button to enable /disable tour. 

 means the tour function is enabled and  means the tour function is disabled.

- On the navigation bar, click  or  to enable/disable tour function.



Figure 4-112

4.10.5.2.4 Zero-channel Encoding

Click zero-channel encoding button, you can go to the following interface. See Figure 4-113. Here you can enable and set zero-channel encoding function so that you can view several video sources at one channel.

- **Enable:** This function is disabled by default. Check the box here to enable this function so that you can control the zero-channel encoding function at the WEB.
- **Compression:** System default setup is H.264. You can set according to device capability.
- **Resolution:** The resolution value may vary due to different device capabilities. Please select from the dropdown list.
- **Frame rate:** The frame rate value may vary due to different device capabilities. Please select from the dropdown list.
- **Bit Rate:** The bit rate value may vary due to different device capabilities and frame rate setups. Please select from the dropdown list.
- **Save:** Click the Save button to save current setup. If this function is disabled, you can not operate zero-channel encoding function at the WEB, the video is black or null even you operate when the function is disabled. After you enabled this function, login

the Web and you can select zero-channel encoding mode at the right corner of the

interface . Select a mode; you can view the local preview video.



Figure 4-113

4.10.5.2.5 Favorites

It is for you to set and save favorites preview setup. You can select different window display modes and then select corresponding channel(s). Please note for one mode, one channel can only be selected once. See Figure 4-114.

- Set channels: Click it you get channel setup information of current preview interface. For example. If you window split mode is 4 and channel setup includes channel 1/2/3/4, you can see 4 from the split dropdown list and then see channel 1/2/3/4 at the middle of the interface.
- Get channels: Click it to activate current setup. You can see current setup effect on the screen right now.
- Default: it is to restore factory default setup. For example, 1-window mode, it is to display channel 1 and 4-window mode, it is display channel 1/2/3/4.
- Save: Click it to save current setup to Favorites folder. Otherwise, you can not find current setup in the Favorites.

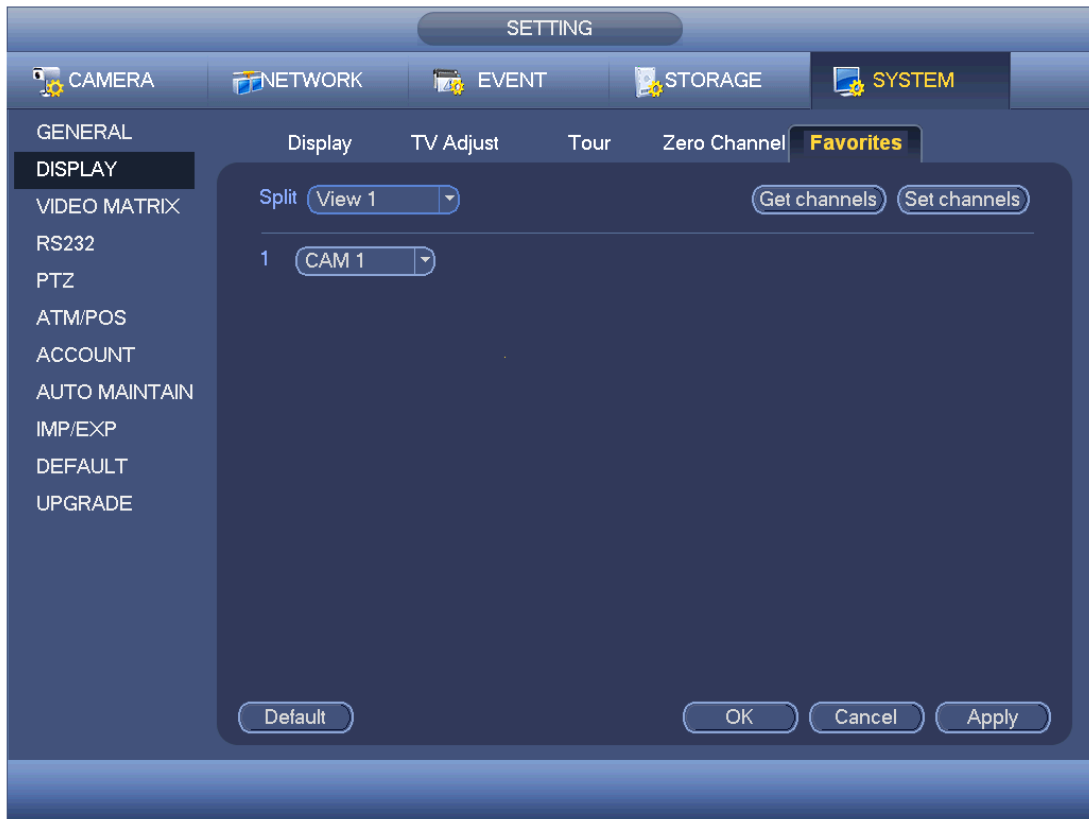

Figure 4-114

On the navigation bar, you can see the Favorites shortcut menu. You can select from the dropdown list. Click View 1, you can see the channel(s) you saved on the Favorites folder. See Figure 4-115.

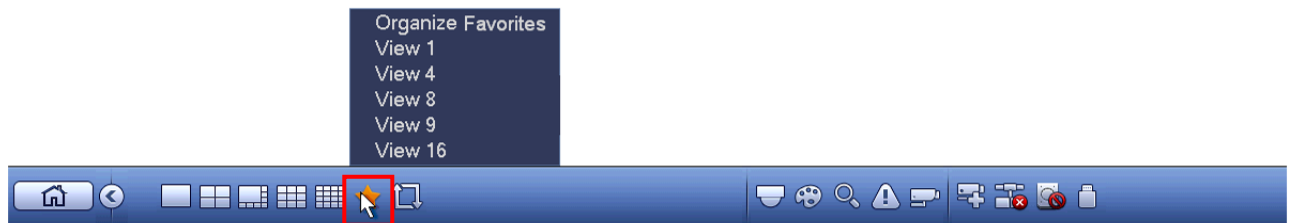

Figure 4-115

4.10.5.3 Video Matrix

Here you can set matrix output channel and its interval. System supports 1/4-window (and etc) SPOT tour. See Figure 4-116.



Figure 4-116

4.10.5.4 RS232

RS232 interface is shown as below. There are five items. See Figure 4-117.

- Function: There are various devices for you to select. Console is for you to use the COM or mini-end software to upgrade or debug the program. The control keyboard is for you to control the device via the special keyboard. Transparent COM (adapter) is to connect to the PC to transfer data directly. Protocol COM is for card overlay function. Network keyboard is for you to use the special keyboard to control the device. PTZ matrix is to connect to the peripheral matrix control.
- Baud rate: You can select proper baud rate.
- Data bit: You can select proper data bit. The value ranges from 5 to 8.
- Stop bit: There are two values: 1/2.
- Parity: There are five choices: none/odd/even/space mark.

System default setup is:

- Function: Console
- Baud rate:115200
- Data bit:8
- Stop bit:1
- Parity: None

After completing all the setups please click save button, system goes back to the previous menu.



Figure 4-117

4.10.5.5 PTZ

The pan/tilt/zoom setup includes the following items. Please select channel first. See Figure 4-118.

- Control mode: You can select control mode from the dropdown list. There are two options: Serial/HDCVI. For HDCVI series product, please select HDCVI. The control signal is sent to the PTZ via the coaxial cable. For the serial mode, the control signal is sent to the PTZ via the RS485 port.
- Protocol: Please select DH-SD1 if the control mode is HDCVI.
- Address: input corresponding PTZ address.
- Baud rate: Select baud rate.
- Data bit: Select data bit.
- Stop bit: Select stop bit.
- Parity: There are three choices: none/odd/even.

After completed all the setups please click save button, system goes back to the previous menu.



Figure 4-118

4.10.5.6 ATM/POS

The ATM/POS function is for financial areas. It includes Sniffer, information analysis and title overlay function. The Sniffer mode includes COM and network.

4.10.5.6.1 COM Type

The COM interface is shown as below. See Figure 4-119.

- Protocol: Please select from the dropdown list.
- Setting: Click COM setting button, the interface is shown as in RS232 interface. Please refer to Chapter 5.3.4 RS232.
- Overlay channel: Please select the channel you want to overlay the card number.
- Overlay mode: There are two options: preview and encode. Preview means overlay the card number in the local monitor video. Encode means overlay the card number in the record file.
- Overlay Position: Here you can select the proper overlay position from the dropdown list.

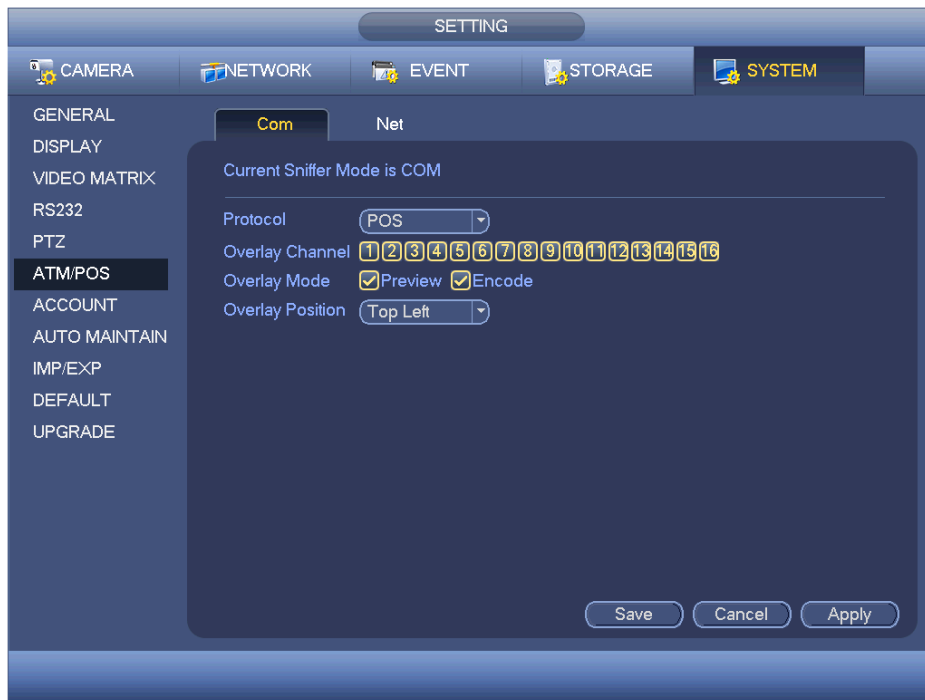

Figure 4-119

4.10.5.6.2 Network Type

The network type interface is shown as below. See Figure 4-120.

Here we take the ATM/POS protocol to continue.

There are two types: with or without the protocol according to client's requirements.

With the protocol

For ATM/POS with the protocol, you just need to set the source IP, destination IP (sometimes you need to input corresponding port number).



Figure 4-120

Without the protocol

For the ATM/POS without the protocol, the interface is shown as in Figure 4-121.

Source IP refers to host IP address that sends out information (usually it is the device host.)

Destination IP refers to other systems that receive information.

Usually you do not need to set source port and target port.

There are total four groups IP. The record channel applies to one group (optional) only.

Six frame ID groups verification can guarantee information validity and legal.



Figure 4-121

4.10.5.7 Account

Here is for you to implement account management. See Figure 4-122 and Figure 4-123.

Here you can:

- Add new user
- Modify user
- Add group
- Modify group
- Modify password.

For account management please note:

- For the user account name and the user group, the string max length is 6-byte. The backspace in front of or at the back of the string is invalid. There can be backspace in the middle. The string includes the valid character, letter, number, underline, subtraction sign, and dot.
- The default user amount is 64 and the default group amount is 20. System account adopts two-level management: group and user. No limit to group or user amount.
- For group or user management, there are two levels: admin and user.

- The user name and group name can consist of eight bytes. One name can only be used once. There are four default users: admin/888888/666666 and hidden user “default”. Except user 6666, other users have administrator right.
- Hidden user “default” is for system interior use only and can not be deleted. When there is no login user, hidden user “default” automatically login. You can set some rights such as monitor for this user so that you can view some channel view without login.
- One user should belong to one group. User right can not exceed group right.
- About reusable function: this function allows multiple users use the same account to login.
- About user account and MAC. When you add a new user, you can input the MAC address of current user. Only the user of the same MAC address can access the device remotely.(MAC address is for the device of the same LAN.) If you leave MAC address item in blank when you add a new user, the user of any MAC address can access the device remotely. You can set or change MAC address when you add or modify a user. The MAC address function is also valid for PSS login. **Please note current function does not support IPV6.**

After all the setups please click save button, system goes back to the previous menu.



Figure 4-122



Figure 4-123

4.10.5.7.1 Add/Modify Group

Click add group button in Figure 4-123 , the interface is shown as below. See Figure 4-124.

Here you can input group name and then input some memo information if necessary.

There are total 98 rights such as control panel, shut down, real-time monitor, playback, record, record file backup, PTZ, user account, system information view, alarm input/output setup, system setup, log view, clear log, upgrade system, control device and etc.

The modify group interface is similar to the Figure 4-124.



Figure 4-124

4.10.5.7.2 Add/Modify User

Click add user button in Figure 4-122 , the interface is shown as in Figure 4-125.

Please input the user name, password, select the group it belongs to from the dropdown list.

Then you can check the corresponding rights for current user.

For convenient user management, usually we recommend the general user right is lower than the admin account.

The modify user interface is similar to Figure 4-125.

The screenshot shows the 'Add User' configuration window. It has a title bar 'Add User'. The form contains the following fields and options:

- User Name: [text input]
- Password: [text input]
- Memo: [text input]
- Group: [dropdown menu, selected 'admin']
- Reusable: [checkbox, unchecked]
- Confirm Password: [text input]
- User MAC: [text input]

Below the form is the 'Authority' section with three tabs: 'System', 'Playback', and 'Monitor'. The 'System' tab is selected. It contains a grid of permissions, each with a checked checkbox:

<input checked="" type="checkbox"/> All	<input checked="" type="checkbox"/> SYSTEM	<input checked="" type="checkbox"/> DISCONNECT USER	<input checked="" type="checkbox"/> DEFAULT&UPGRADE
<input checked="" type="checkbox"/> ACCOUNT	<input checked="" type="checkbox"/> INFO	<input checked="" type="checkbox"/> MANUAL CONTROL	<input checked="" type="checkbox"/> BACKUP
<input checked="" type="checkbox"/> PTZ	<input checked="" type="checkbox"/> STORAGE	<input checked="" type="checkbox"/> EVENT	<input checked="" type="checkbox"/> NETWORK
<input checked="" type="checkbox"/> COLOR	<input checked="" type="checkbox"/> CLEAR LOG	<input checked="" type="checkbox"/> SHUTDOWN	
<input checked="" type="checkbox"/> CAMERA			

At the bottom right of the window are 'Save' and 'Cancel' buttons.

Figure 4-125

When you create a new user, you can input the corresponding MAC address of current user. If you leave this item in blank, any MAC address user can share this user account to login. Please note system needs to check the validity of MAC. Only the 12-digit 0-f format address can pass the validity verification. System only saves small character even you input capitalized one. You can see the corresponding prompt if there is any illegal input.

4.10.5.8 Auto Maintain

Here you can set auto-reboot time and auto-delete old files setup. You can set to delete the files for the specified days. See Figure 4-126.

You can select proper setup from dropdown list.

After all the setups please click save button, system goes back to the previous menu.

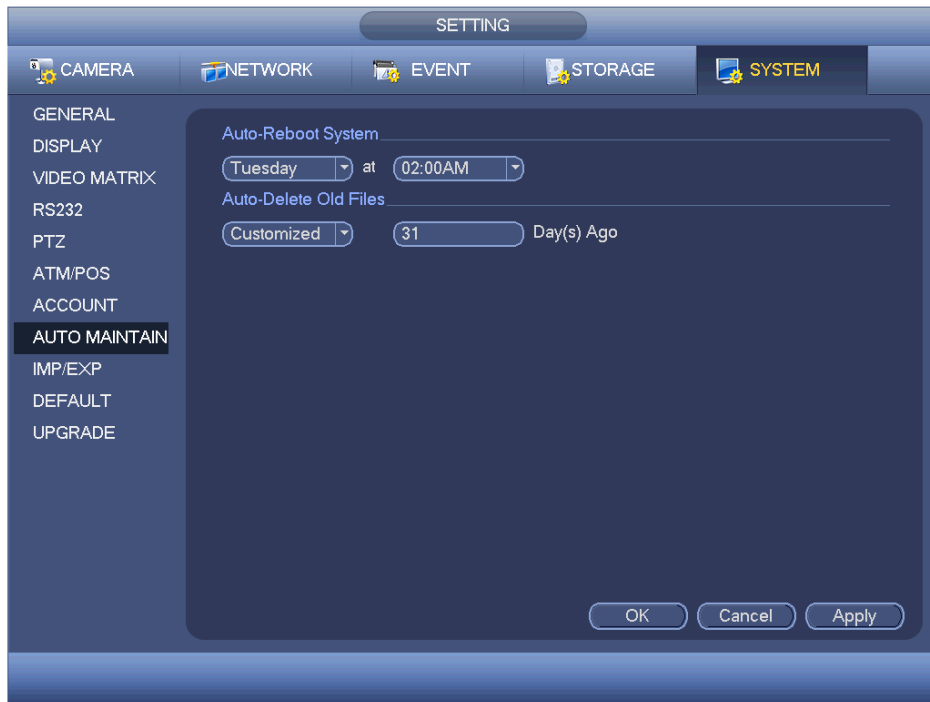

Figure 4-126

4.10.5.9 Config Backup

The configuration file backup interface is shown as below. See Figure 4-127.

This function allows you to import/export system configuration. You can use this function when there are several devices need the same setup.

- Export: Please connect the peripheral device first and then go to the following interface. Click Export button, you can see there is a corresponding “Config_Time” folder. Double click the folder, you can view some backup files.
- Import: Here you can import the configuration files from the peripheral device to current device. You need to select a folder first. You can see a dialogue box asking you to select a folder if you are selecting a file. System pops up a dialogue box if there is no configuration file under current folder. After successfully import, system needs to reboot to activate new setup.
- Format: Click Format button, system pops up a dialogue box for you to confirm current operation. System begins format process after you click the OK button.

Note:

- System can not open config backup interface again if there is backup operation in the process.
- System refreshes device when you go to the config backup every time and set current directory as the root directory of the peripheral device.
- If you go to the configuration backup interface first and then insert the peripheral device, please click Refresh button to view the newly added device.



Figure 4-127

4.10.5.10 Default

Click default icon, system pops up a dialogue box. You can highlight  to restore default factory setup. See Figure 4-128.

- Camera
- Network
- Event
- Storage
- System

Please highlight icon  to select the corresponding function.

After all the setups please click save button, system goes back to the previous menu.

Warning!

System menu color, language, time display mode, video format, IP address, user account will not maintain previous setup after default operation!

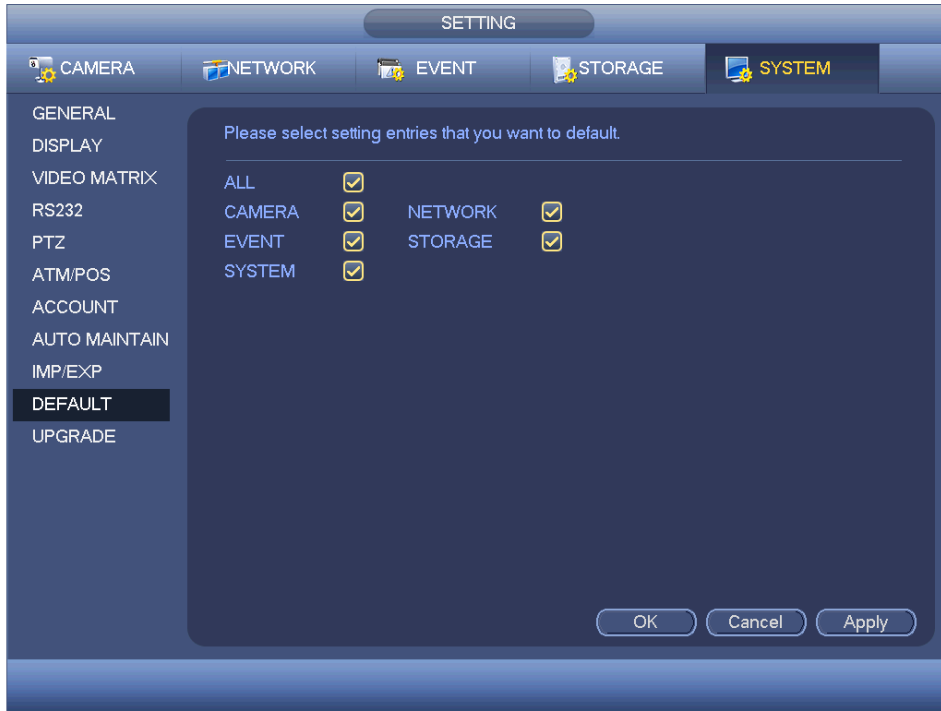

Figure 4-128

4.10.5.11 Update

Here is for you to view hardware features, software version, built date, release SN information and etc. You can also update system here. See Figure 4-129.

- Start: Please insert the USB device that have the update file to the device and then click the Start button to begin the update.

Important

Please make sure the upgrade file name shall be update.bin.

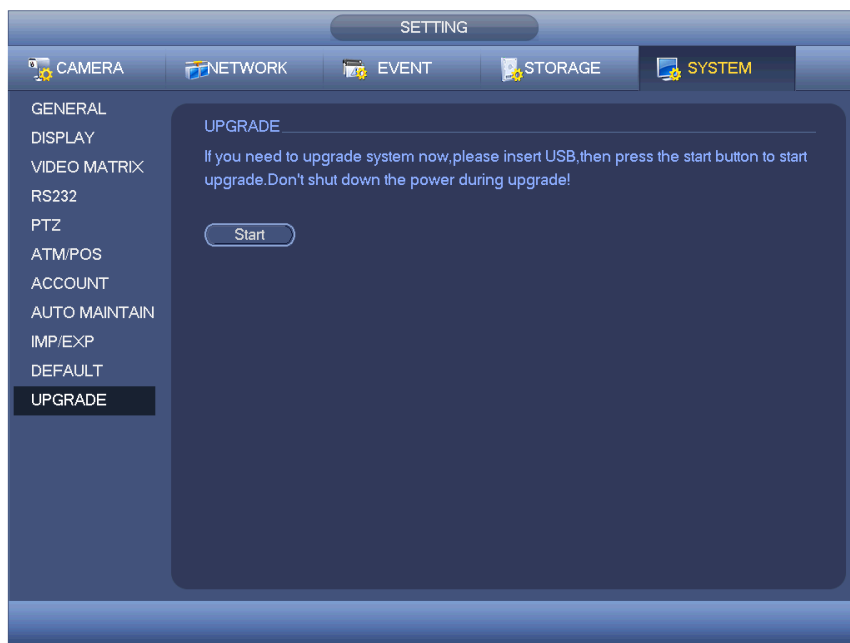

Figure 4-129

5 WEB OPERATION

Slightly difference may be found in the interface due to different series.

5.1 Network Connection

Before web client operation, please check the following items:

- Network connection is right
- DVR and PC network setup is right. Please refer to network setup(main menu->Setting->Network)
- Use order ping `***.***.***.***`(* DVR IP address) to check connection is OK or not. Usually the return TTL value should be less than 255.
- Current series product supports various browsers such as Safari, fire fox browser, Google browser. Device supports multiple-channel monitor, PTZ control, DVR parameter setup on the Apple PC.

5.2 Login

Open IE and input DVR address in the address column. For example, if your DVR IP is 10.10.3.16, then please input `http:// 10.10.3.16` in IE address column.

System pops up warning information to ask you whether install control or not. Please click Install button. See Figure 5-1.

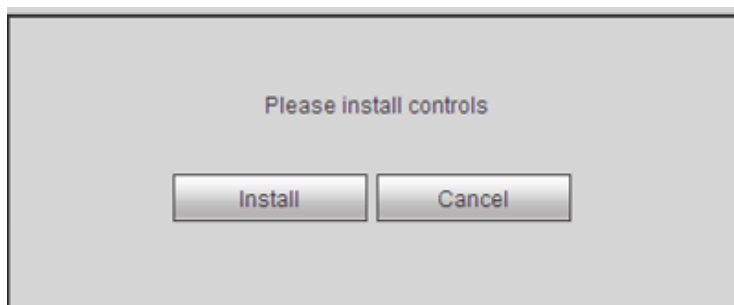

Figure 5-1

After installation, the interface is shown as below. See Figure 5-2.

Please input your user name and password.

Default factory name is admin and password is admin.

Note: For security reasons, please modify your password after you first login.

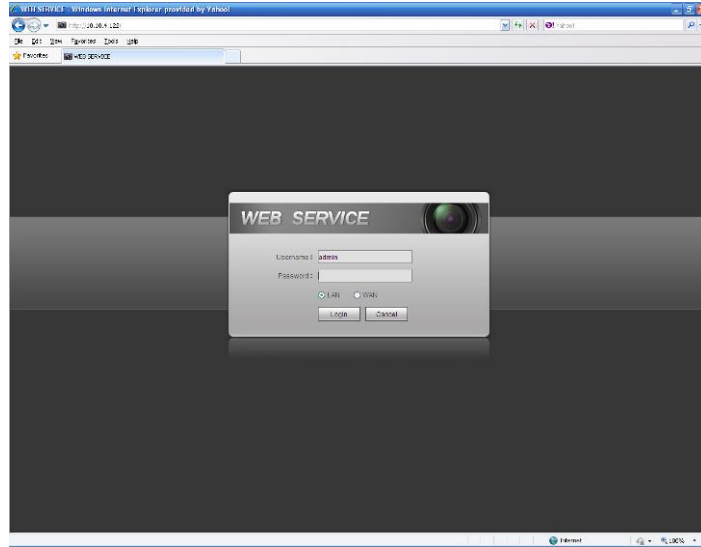

Figure 5-2

5.3 LAN Mode

For the LAN mode, after you logged in, you can see the main window. See Figure 5-3.

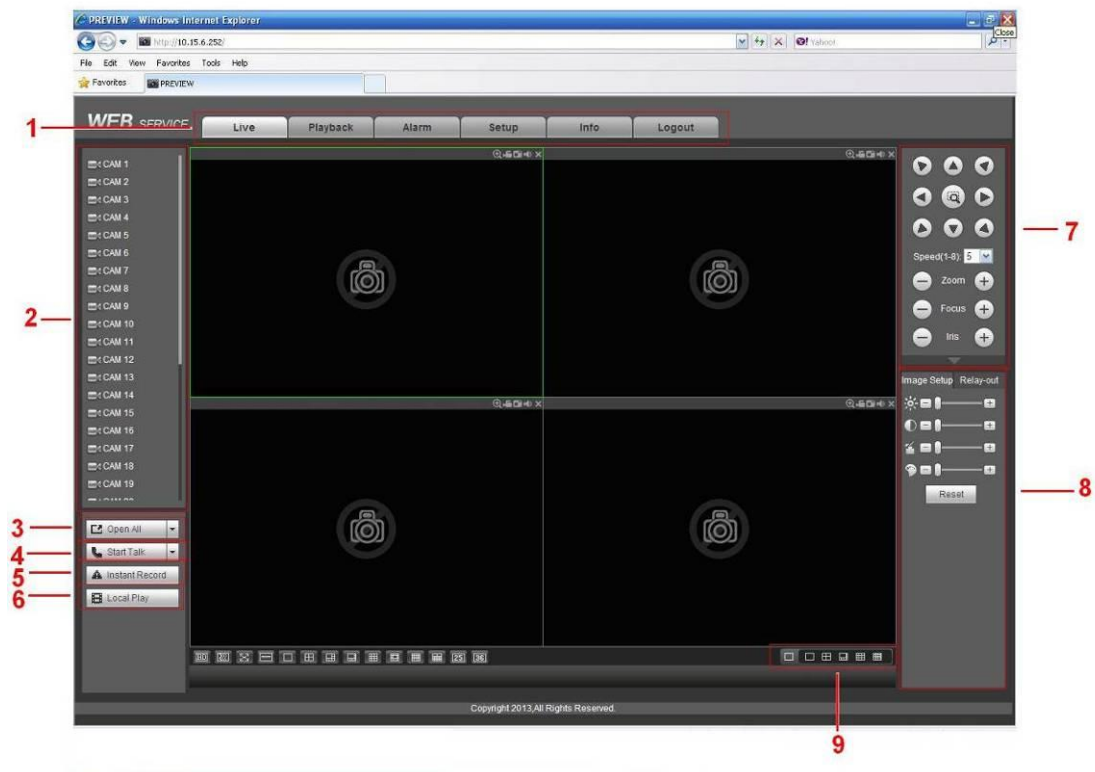

Figure 5-3

This main window can be divided into the following sections.

- Section 1: there are five function buttons: Live (chapter 5.4), setup (chapter 5.8), search (chapter 5.10), alarm (chapter 5.11), and logout (chapter 5.12).

- Section 2: There are channel number and one button: Start all. Start all button is to enable/disable all-channel real-time monitor. Click it the button becomes yellow. See Figure 5-4.

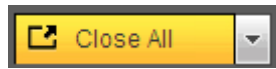

Figure 5-4

Please refer to Figure 5-5 for main stream and extra stream switch information.

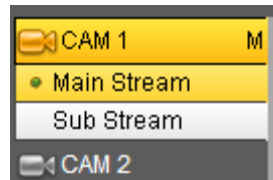

Figure 5-5

- Section 3: Start dialogue button.

You can click this button to enable audio talk. Click 【▼】 to select bidirectional talk mode. There are four options: DEFAULT, G711a, G711u and PCM. After you enable the bidirectional talk, the Start talk button becomes End Talk button and it becomes yellow. See Figure 5-6.

Please note, if audio input port from the device to the client-end is using the first channel audio input port. During the bidirectional talk process, system will not encode the audio data from the 1-channel.

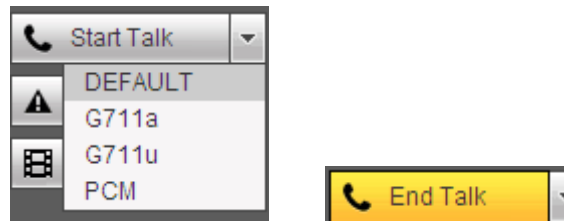

Figure 5-6

- Section 4: Instant record button. Click it, the button becomes yellow and system begins manual record. See Figure 5-7. Click it again, system restores previous record mode..

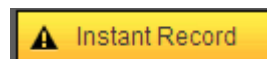

Figure 5-7

- Section 5: Local play button.

The Web can playback the saved (Extension name is dav) files in the PC-end. Click local play button, system pops up the following interface for you to select local play file. See Figure 5-8.



Figure 5-8

- Section 6: From the left to the right ,you can see video quality/fluency/ full screen/1-window/4-window/6-window/8-window/9-window/13-window/16-window/20-window/25-window/36-window.. You can set video fluency and real-time feature priority.
- Section 7: PTZ operation panel. Please refer to chapter 5.5 for detailed information.
- Section 8: Image setup and alarm setup. Please refer to chapter 5.6 for detailed information.
- Section 9: Zero-channel encoding. This function allows you to view several-window in one channel. It supports 1/4/8/9-window.

5.4 Real-time Monitor

In section 2, left click the channel name you want to view, you can see the corresponding video in current window.

On the top left corner, you can view device IP, channel number, network monitor bit stream. See Figure 5-9.

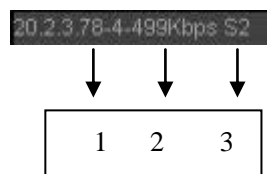

Figure 5-9

On the top right corner, there are six function buttons. See Figure 5-10.

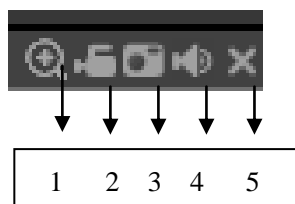

Figure 5-10

- 1: Digital zoom: Click this button and then left drag the mouse in the zone to zoom in. right click mouse system restores original status.
- 2: Local record. When you click local record button, the system begins recording and this button becomes highlighted. You can go to system folder RecordDownload to view the recorded file.
- 3: Snapshot picture. You can snapshot important video. All images are memorized in system client folder PictureDownload (default).
- 4: Audio :Turn on or off audio.(It has no relationship with system audio setup)
- 5: Close video.

5.5 PTZ

Before PTZ operation, please make sure you have properly set PTZ protocol. (Please refer to chapter 5.8.5.5).

There are eight direction keys. In the middle of the eight direction keys, there is a 3D intelligent positioning key.

Click 3D intelligent positioning key, system goes back to the single screen mode. Drag the mouse in the screen to adjust section size. It can realize PTZ automatically.

Please refer to the following sheet for PTZ setup information.

Parameter	Function
Scan	<ul style="list-style-type: none"> ● Select Scan from the dropdown list. ● Click Set button, you can set scan left and right limit. ● Use direction buttons to move the camera to you desired location and then click left limit button. Then move the camera again and then click right limit button to set a right limit.
Preset	<ul style="list-style-type: none"> ● Select Preset from the dropdown list. ● Turn the camera to the corresponding position and Input the preset value. Click Add button to add a preset.
Tour	<ul style="list-style-type: none"> ● Select Tour from the dropdown list. ● Input preset value in the column. Click Add preset button, you have added one preset in the tour. ● Repeat the above procedures you can add more presets in one tour. ● Or you can click delete preset button to remove one preset from the tour.
Pattern	<ul style="list-style-type: none"> ● Select Pattern from the dropdown list. ● You can input pattern value and then click Start button to begin PTZ movement such as zoom, focus, iris, direction and etc. Then you can click Add button to set one pattern.
Aux	<ul style="list-style-type: none"> ● Please input the corresponding aux value here. ● You can select one option and then click AUX on or AUX off button.

Parameter	Function
Light and wiper	You can turn on or turn off the light/wiper.

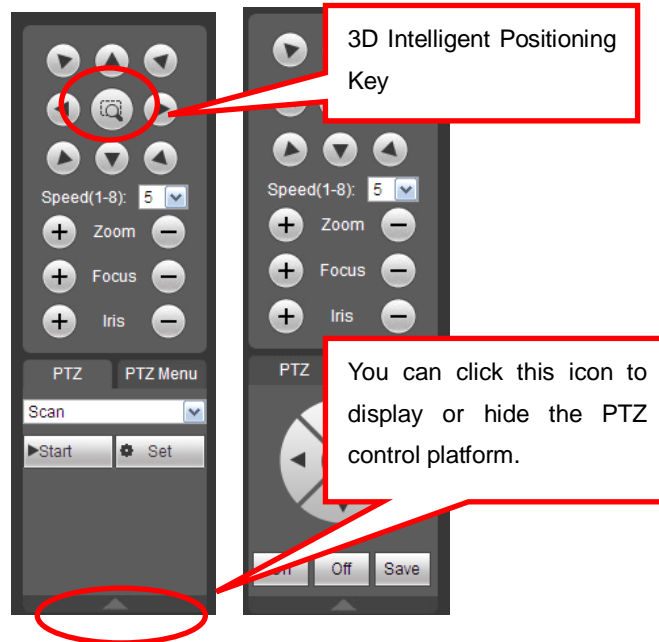

Figure 5-11

5.6 Image/Relay-out

Select one monitor channel video and then click Image button in section 8, the interface is shown as Figure 5-12.

5.6.1 Image

Here you can adjust its brightness, contrast, hue and saturation. (Current channel border becomes green).

Or you can click Reset button to restore system default setup.



Figure 5-12

5.6.2 Relay output

Here you can enable or disable the alarm signal of the corresponding port. See Figure 5-13.

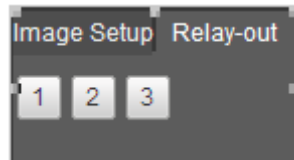

Figure 5-13

5.7 WAN Login

In WAN mode, after you logged in, the interface is shown as below. See Figure 5-14.

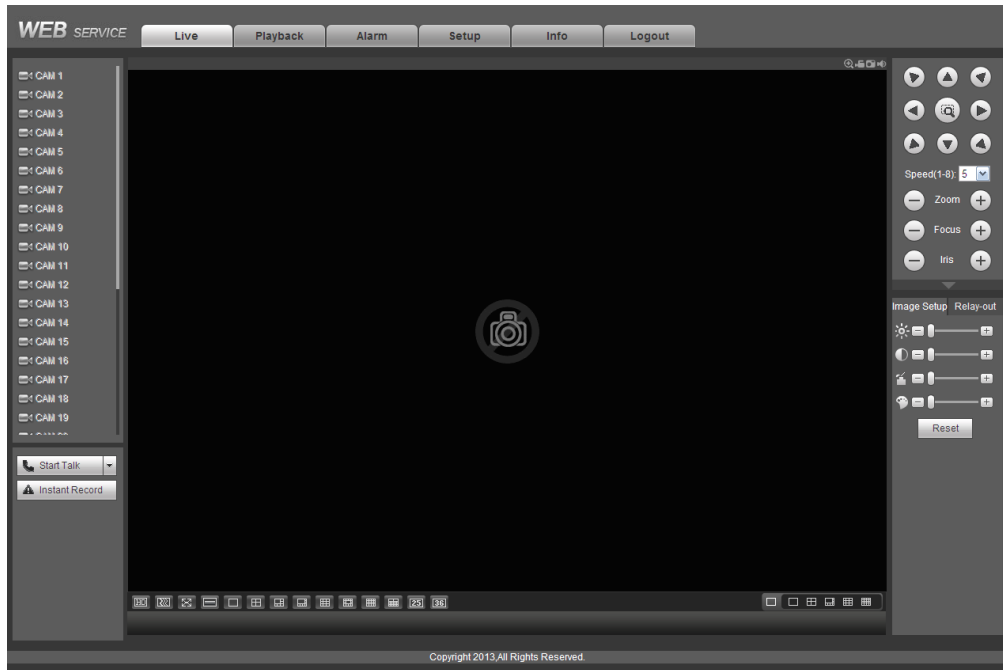

Figure 5-14

Please refer to the following contents for LAN and WAN login difference.

- 1) In the WAN mode, system opens the main stream of the first channel to monitor by default. The open/close button on the left pane is null.
- 2) You can select different channels and different monitor modes at the bottom of the interface. See Figure 5-15.

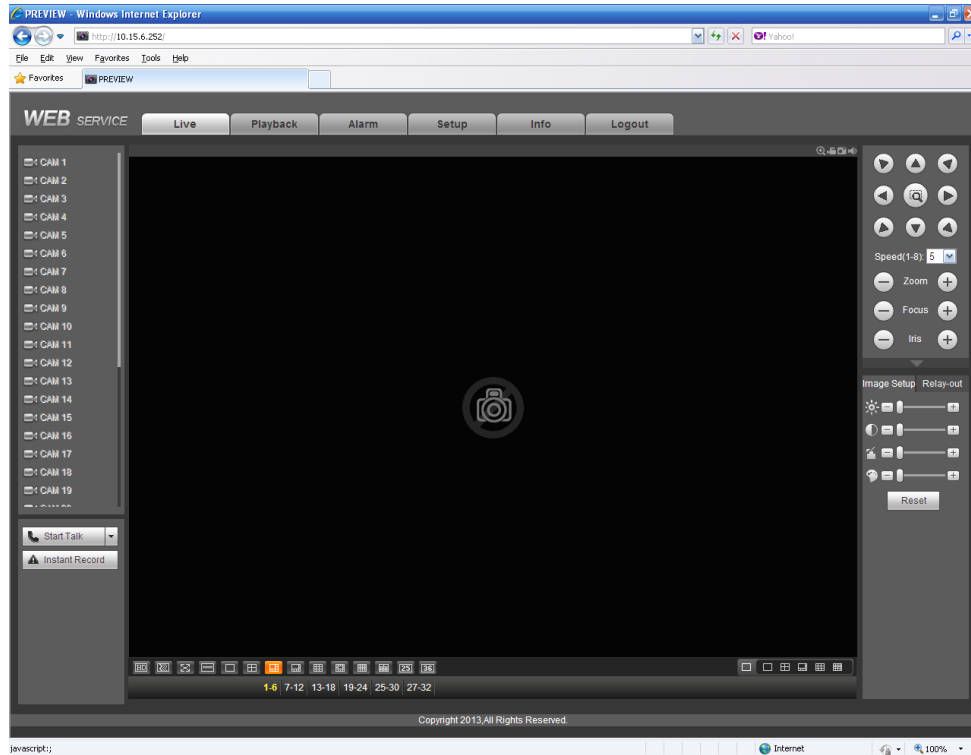

Figure 5-15

Important

The window display mode and the channel number are by default. For example, for the 16-channel, the max window split mode is 16.

3) Multiple-channel monitor, system adopts extra stream to monitor by default. Double click one channel, system switches to single channel and system uses main stream to monitor. You can view there are two icons at the left top corner of the channel number for you reference. M stands for main stream. S stands for sub stream (extra stream).

4) If you login via the WAN mode, system does not support alarm activation to open the video function in the Alarm setup interface.

Important

- For multiple-channel monitor mode, system adopts extra stream to monitor by default. You can not modify manually. All channels are trying to synchronize. Please note the synchronization effect still depends on your network environments.
- For bandwidth consideration, system can not support monitor and playback at the same time. System auto closes monitor or playback interface when you are searching setup in the configuration interface. It is to enhance search speed.

5.8 Setup

5.8.1 Camera

5.8.1.1 Conditions

Here you can view device property information. The setups become valid immediately

after you set. See Figure 5-16.

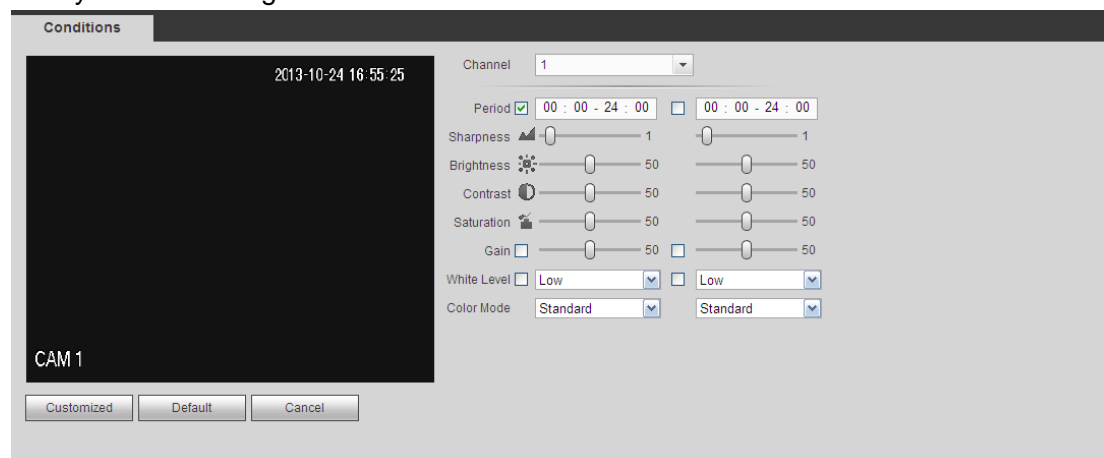

Figure 5-16

Please refer to the following sheet for detailed information.

Parameter	Function
Channel	Please select a channel from the dropdown list.
Period	It divides one day (24 hours) to two periods. You can set different hue, brightness, and contrast for different periods.
Hue	It is to adjust monitor video brightness and darkness level. The default value is 50. The bigger the value is, the large the contrast between the bright and dark section is and vice versa.
Brightness	It is to adjust monitor window brightness. The default value is 50. The larger the number is, the bright the video is. When you input the value here, the bright section and the dark section of the video will be adjusted accordingly. You can use this function when the whole video is too dark or too bright. Please note the video may become hazy if the value is too high. The value ranges from 0 to 100. The recommended value ranges from 40 to 60.
Contrast	It is to adjust monitor window contrast. The value ranges from 0 to 100. The default value is 50. The larger the number is, the higher the contrast is. You can use this function when the whole video bright is OK but the contrast is not proper. Please note the video may become hazy if the value is too low. If this value is too high, the dark section may lack brightness while the bright section may over exposure. The recommended value ranges from 40 to 60.
Saturation	It is to adjust monitor window saturation. The value ranges from 0 to 100. The default value is 50. The larger the number is, the strong the color is. This value has no effect on the general brightness of the whole video. The video color may become too strong if the value is too high. For the grey part of the video, the distortion may occur if the white balance is not accurate. Please note the video may not be attractive if the value is too low. The recommended value ranges

	from 40 to 60.
Color mode	It includes several modes such as standard, color. You can select corresponding color mode here, you can see hue, brightness, and contrast and etc will adjust accordingly.

5.8.1.2 Encode

5.8.1.2.1 Encode

The encode interface is shown as below. See Figure 5-17.

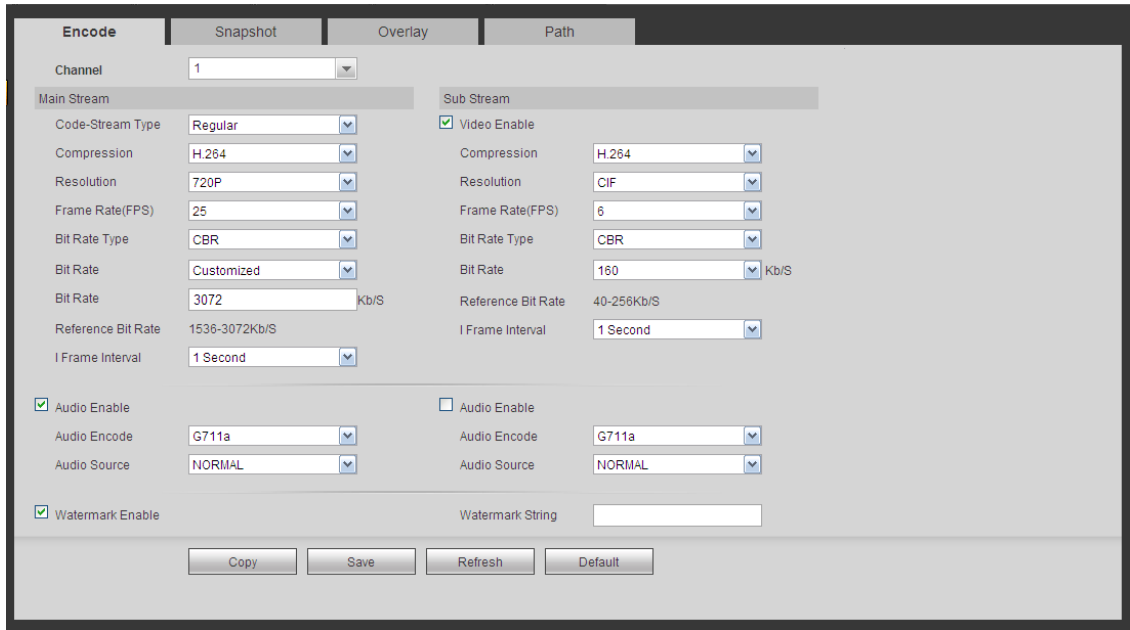

Figure 5-17

Please refer to the following sheet for detailed information.

Parameter	Function
Channel	Please select a channel from the dropdown list.
Video enable	Check the box here to enable extra stream video. This item is enabled by default.
Code stream type	It includes main stream, motion stream and alarm stream. You can select different encode frame rates form different recorded events. System supports active control frame function (ACF). It allows you to record in different frame rates. For example, you can use high frame rate to record important events, record scheduled event in lower frame rate and it allows you to set different frame rates for motion detection record and alarm record.
Compression	The main bit stream supports H.264. The extra stream supports H.264, MJPG.
Resolution	System supports various resolutions, you can select from the dropdown list. Please note the option may vary due to different series.

Frame Rate	PAL: 1~25f/s; NTSC: 1~30f/s.
Bit Rate	<ul style="list-style-type: none"> ● Main stream: You can set bit rate here to change video quality. The large the bit rate is , the better the quality is. Please refer to recommend bit rate for the detailed information. ● Extra stream: In CBR, the bit rate here is the max value. In dynamic video, system needs to low frame rate or video quality to guarantee the value. The value is null in VBR mode.
Reference bit rate	Recommended bit rate value according to the resolution and frame rate you have set.
I Frame	Here you can set the P frame amount between two I frames. The value ranges from 1 to 150. Default value is 50. Recommended value is frame rate *2.
Audio source	Please select from the dropdown list. There are two options: Normal/HDCVI. In the normal mode, the audio signal comes from the Audio In. In the HDCVI mode, the audio signal comes from the coaxial cable of the camera.
Watermark enable	This function allows you to verify the video is tampered or not. Here you can select watermark bit stream, watermark mode and watermark character. Default character is DigitalCCTV. The max length is 85-digit. The character can only include number, character and underline.

5.8.1.2.2 Snapshot

The snapshot interface is shown as in Figure 5-18.

Figure 5-18

Please refer to the following sheet for detailed information.

Parameter	Function
Snapshot type	There are two modes: Regular (schedule) and Trigger. <ul style="list-style-type: none"> ● Regular snapshot is valid during the specified period you set. ● Trigger snapshot only is valid when motion detect alarm, tampering alarm or local activation alarm occurs.
Image size	It is the same with the resolution of the main stream.
Quality	It is to set the image quality. There are six levels.
Interval	It is to set snapshot frequency. The value ranges from 1s to 7s.

	Or you can set customized value. The max setup is 3600s/picture.
Copy	Click it; you can copy current channel setup to other channel(s).

5.8.1.2.3 Video Overlay

The video overlay interface is shown as in Figure 5-19.

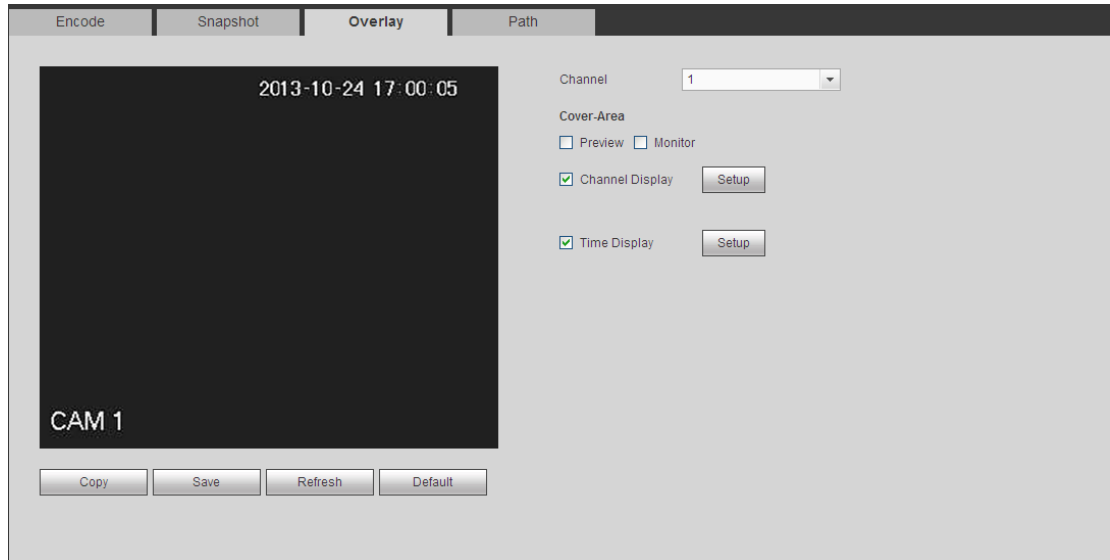

Figure 5-19

Please refer to the following sheet for detailed information.

Parameter	Function
Cover-area	Check Preview or Monitor first. Click Set button, you can privacy mask the specified video in the preview or monitor video. System max supports 4 privacy mask zones.
Time Title	You can enable this function so that system overlays time information in video window. You can use the mouse to drag the time title position. You can view time title on the live video of the WEB or the playback video.
Channel Title	You can enable this function so that system overlays channel information in video window. You can use the mouse to drag the channel title position. You can view channel title on the live video of the WEB or the playback video.

5.8.1.2.4 Path

The storage path interface is shown as in Figure 5-20.

Here you can set snap image saved path ( in the preview interface) and the record

storage path ( in the preview interface).The default setup is C:\PictureDownload and C:\RecordDownload.

Please click the Save button to save current setup.

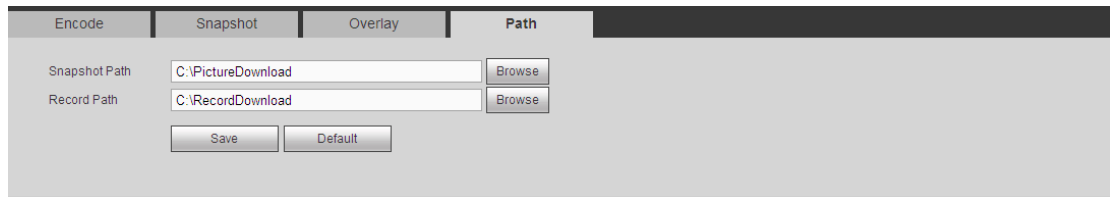

Figure 5-20

5.8.1.3 Channel Name

Here you can set channel name. See Figure 5-21.

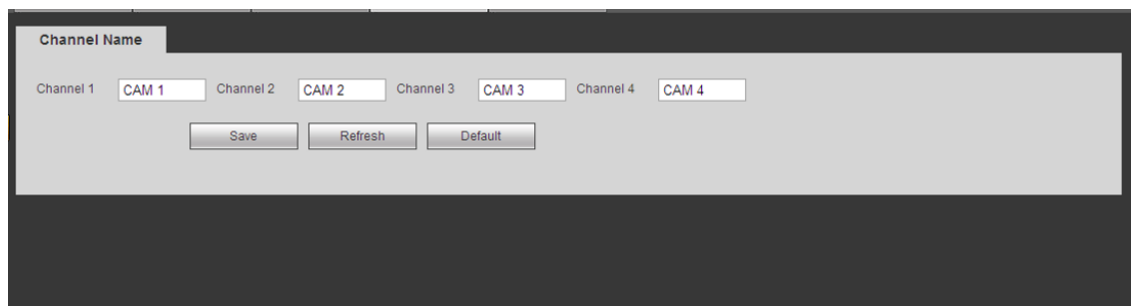

Figure 5-21

5.8.2 Network

5.8.2.1 TCP/IP

The TCP/IP interface is shown as in Figure 5-22.

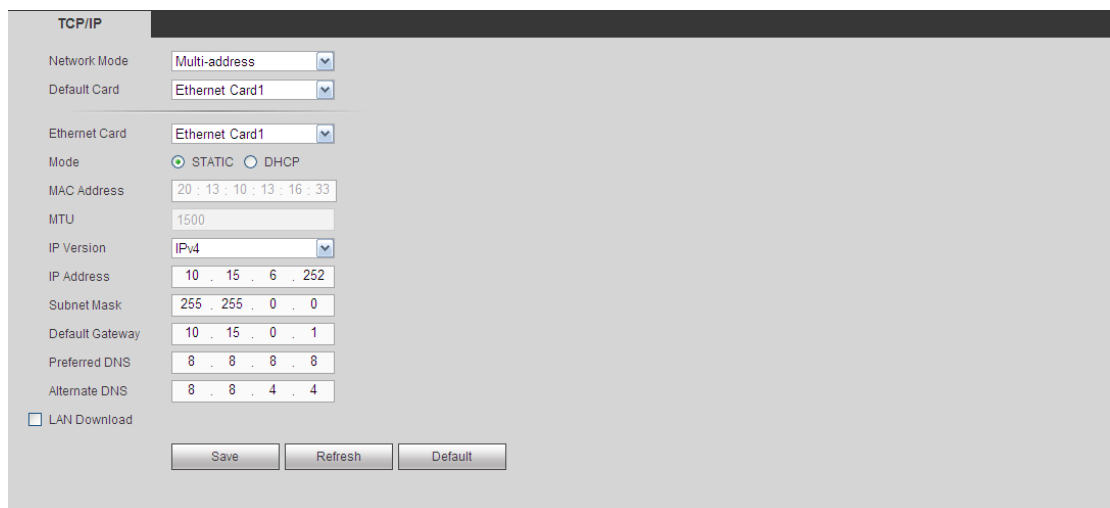

Figure 5-22

Please refer to the following sheet for detailed information.

Parameter	Function
Mode	There are two modes: static mode and the DHCP mode.

	<ul style="list-style-type: none"> ● The IP/submask/gateway are null when you select the DHCP mode to auto search the IP. ● If you select the static mode, you need to set the IP/submask/gateway manually. ● If you select the DHCP mode, you can view the IP/submask/gateway from the DHCP. ● If you switch from the DHCP mode to the static mode, you need to reset the IP parameters. ● Besides, IP/submask/gateway and DHCP are read-only when the PPPoE dial is OK.
Mac Address	It is to display host Mac address.
IP Version	It is to select IP version. IPV4 or IPV6. You can access the IP address of these two versions.
IP Address	Please use the keyboard to input the corresponding number to modify the IP address and then set the corresponding subnet mask and the default gateway.
Preferred DNS	DNS IP address.
Alternate DNS	Alternate DNS IP address.
For the IP address of IPv6 version, default gateway, preferred DNS and alternate DNS, the input value shall be 128-digit. It shall not be left in blank.	
LAN load	System can process the downloaded data first if you enable this function. The download speed is 1.5X or 2.0X of the normal speed.

5.8.2.2 Connection

The connection interface is shown as in Figure 5-23.

The screenshot shows a configuration window titled "Connection". It contains several input fields with their respective ranges:

- Max Connection: 128 (0~128)
- TCP Port: 37777 (200~65535)
- UDP Port: 37778 (200~65535)
- HTTP Port: 80 (1~65535)
- HTTPS Port: 443 (128~65535)
- RTSP Port: 554 (128~65535)

The RTSP Format field contains the following text: `rtsp://<User Name>:<Password>@<IP Address>:<Port>/cam/realmonitor?channel=1&subtype=0`
channel: Channel, 1-32; subtype: Code-Stream Type, Main Stream 0, Sub Stream 1.

At the bottom, there are three buttons: "Save", "Refresh", and "Default".

Figure 5-23

Please refer to the following sheet for detailed information.

Parameter	Function
Max connection	It is the max Web connection for the same device. The value ranges from 1 to 120. The default setup is 120.
TCP port	The default value is 37777. You can input the actual port number if necessary.

UDP port	The default value is 37778. You can input the actual port number if necessary.
HTTP port	The default value is 80. You can input the actual port number if necessary.
HTTPS	The default value is 443. You can input the actual port number if necessary.
RTSP port	The default value is 554.

5.8.2.3 WIFI

Please note this function is for the device of WIFI module.

The WIFI interface is shown as in Figure 5-24.

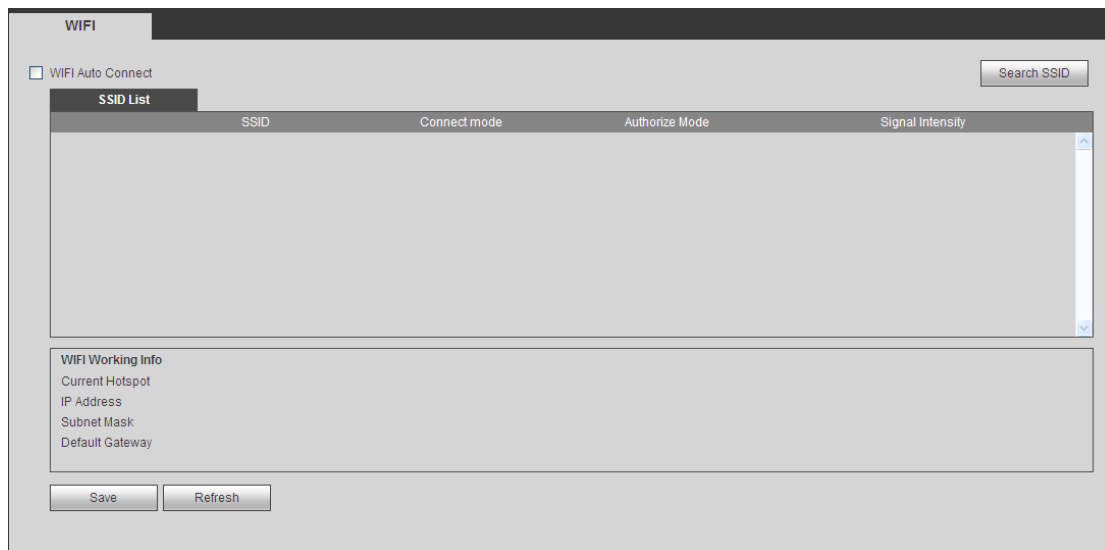

Figure 5-24

Please check the box to enable WIFI function and then click the Search SSID button. Now you can view all the wireless network information in the following list. Double click a name to connect to it. Click Refresh button, you can view latest connection status.

5.8.2.4 3G

5.8.2.4.1 CDMA/GPRS

The CDMA/GPRS interface is shown as in Figure 5-25.

The screenshot shows a web-based configuration page titled "CDMA/GPRS Setup" with a sub-tab "Mobile Setup". The page contains several input fields and checkboxes:

- WLAN Type:** A dropdown menu set to "No Service" with an "Enable" checkbox.
- APN:** An empty text input field with a "Dial/SMS Activate" checkbox.
- AUTH:** A dropdown menu set to "PAP".
- Dial No.:** An empty text input field.
- User Name:** An empty text input field.
- Password:** An empty text input field.
- Pulse Interval:** An empty text input field followed by the unit "Second".
- WLAN Status:** A section containing an "IP Address" text input field.
- Wireless Signal:** A "Search" button.
- Bottom Buttons:** "Save", "Refresh", and "Default" buttons.

Figure 5-25

Please refer to the following sheet for detailed information.

Parameter	Function
WLAN type	Here you can select 3G network type to distinguish the 3G module from different ISP. The types include WCDMA, CDMA1x and etc.
APN/Dial No.	Here is the important parameter of PPP.
Authorization	It includes PAP,CHAP,NO_AUTH.
Pulse interval	It is to set time to end 3G connection after you close extra stream monitor. For example, if you input 60 here, system ends 3G connection after you close extra stream monitor 60 seconds.
Important	
<ul style="list-style-type: none"> ✧ If the pulse interval is 0, then system does not end 3G connection after you close the extra stream monitor. ✧ Pulse interval here is for extra stream only. This item is null if you are using main stream to monitor. 	

5.8.2.4.2 Mobile

The mobile setup interface is shown as in Figure 5-26.

Here you can activate or turn off the 3G connected phone or mobile phone, or the phone you set to get alarm message.

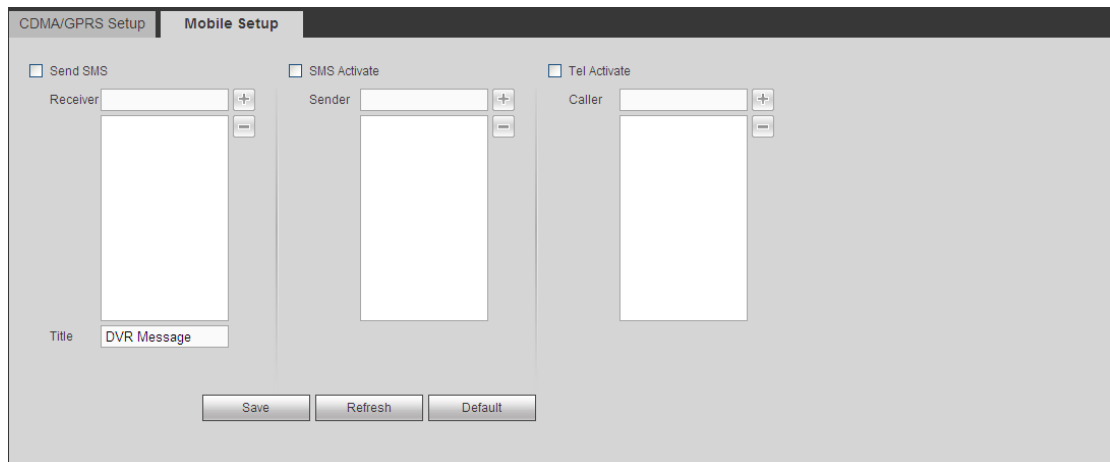

Figure 5-26

5.8.2.5 PPPoE

The PPPoE interface is shown as in Figure 5-27.

Input the PPPoE user name and password you get from the IPS (internet service provider) and enable PPPoE function. Please save current setup and then reboot the device to get the setup activated.

Device connects to the internet via PPPoE after reboot. You can get the IP address in the WAN from the IP address column.

Please note, you need to use previous IP address in the LAN to login the device. Please go to the IP address item to via the device current device information. You can access the client-end via this new address.

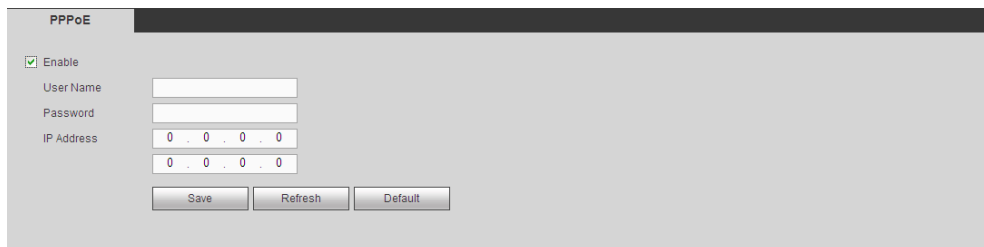

Figure 5-27

5.8.2.6 DDNS

The DDNS interface is shown as in Figure 5-28.

The DDNS is to set to connect the various servers so that you can access the system via the server. Please go to the corresponding service website to apply a domain name and then access the system via the domain. It works even your IP address has changed.

Please select DDNS from the dropdown list (Multiple choices). Before you use this function, please make sure your purchased device support current function.

Figure 5-28

Please refer to the following sheet for detailed information.

Parameter	Function
Server Type	You can select DDNS protocol from the dropdown list and then enable DDNS function.
Server IP	DDNS server IP address
Server Port	DDNS server port.
Domain Name	Your self-defined domain name.
User	The user name you input to log in the server.
Password	The password you input to log in the server.
Update period	Device sends out alive signal to the server regularly. You can set interval value between the device and DDNS server here.

Quick DDNS and Client-end Introduction

1) Background Introduction

Device IP is not fixed if you use ADSL to login the network. The DDNS function allows you to access the DVR via the registered domain name. Besides the general DDNS, the quick DDNS works with the device from the manufacturer so that it can add the extension function.

2) Function Introduction

The quick DDNS client has the same function as other DDNS client end. It realizes the bonding of the domain name and the IP address. Right now, current DDNS server is for our own devices only. You need to refresh the bonding relationship of the domain and the IP regularly. There is no user name, password or the ID registration on the server. At the same time, each device has a default domain name (Generated by MAC address) for your option. You can also use customized valid domain name (has not registered.).

3) Operation

Before you use Quick DDNS, you need to enable this service and set proper server address, port value and domain name.

- Server address: www.quickddns.com
- Port number: 80
- Domain name: There are two modes: Default domain name and customized domain name.

Except default domain name registration, you can also use customized domain name (You can input your self-defined domain name.) After successful registration, you can use domain name to login installed of the device IP.

- User name: It is optional. You can input your commonly used email address.

Important

- Do not register frequently. The interval between two registrations shall be more than 60 seconds. Too many registration requests may result in server attack.
- System may take back the domain name that is idle for one year. You can get a notification email before the cancel operation if your email address setup is OK.

5.8.2.7 IP filter

The IP filter interface is shown as in Figure 5-29.

After you enabled trusted sites function, only the IP listed below can access current DVR. If you enable blocked sites function, the following listed IP addresses can not access current DVR.

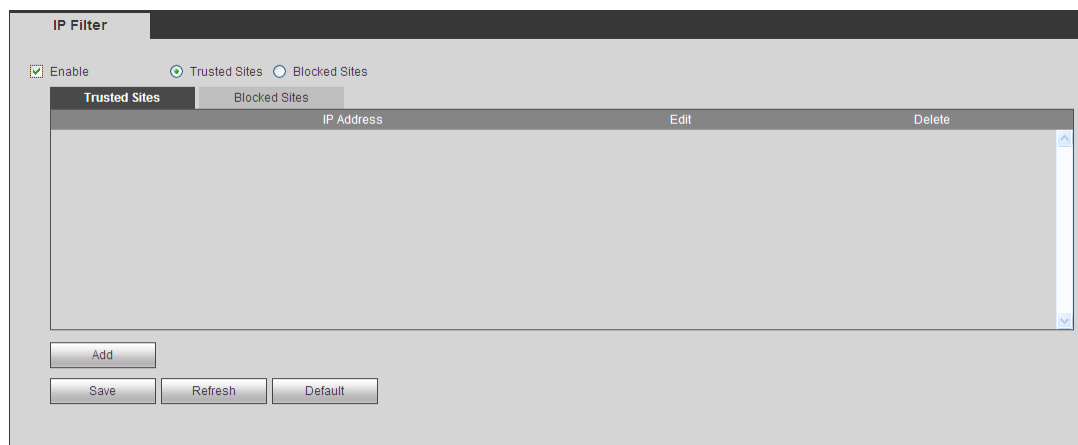

Figure 5-29

5.8.2.8 Email

The email interface is shown as in Figure 5-30.

Figure 5-30

Please refer to the following sheet for detailed information.

Parameter	Function
Enable	Please check the box here to enable email function.
SMTP Server	Input server address and then enable this function.
Port	Default value is 25. You can modify it if necessary.
Anonymity	For the server supports the anonymity function. You can auto login anonymously. You do not need to input the user name, password and the sender information.
User Name	The user name of the sender email account.
Password	The password of sender email account.
Sender	Sender email address.
Authentication (Encryption mode)	You can select SSL or none.
Subject	Input email subject here.
Attachment	System can send out the email of the snapshot picture once you check the box here.
Receiver	Input receiver email address here. Max three addresses. It supports SSL, TLS email box.
Interval	The send interval ranges from 0 to 3600 seconds. 0 means there is no interval. Please note system will not send out the email immediately when the alarm occurs. When the alarm, motion detection or the abnormality event activates the email, system sends out the email according to the interval you specified here. This function is very useful when there are too many emails activated by the abnormality events, which may result in heavy load for the email server.

Parameter	Function
Health mail enable	Please check the box here to enable this function.
Update period (interval)	This function allows the system to send out the test email to check the connection is OK or not. Please check the box to enable this function and then set the corresponding interval. System can send out the email regularly as you set here.
Email test	The system will automatically sent out a email once to test the connection is OK or not .Before the email test, please save the email setup information.

5.8.2.9 FTP

The FTP interface is shown as in Figure 5-31.

It is to set FTP IP, port and etc for remote storage.

Figure 5-31

5.8.2.10 UPnP

It allows you to establish the mapping relationship between the LAN and the public network.

Here you can also add, modify or remove UPnP item. See Figure 5-32.

- In the Windows OS, From Start->Control Panel->Add or remove programs. Click the “Add/Remove Windows Components” and then select the “Network Services” from the Windows Components Wizard.
- Click the Details button and then check the “Internet Gateway Device Discovery and Control client” and “UPnP User Interface”. Please click OK to begin installation.
- Enable UPnP from the Web. If your UPnP is enabled in the Windows OS, the DVR can auto detect it via the “My Network Places”

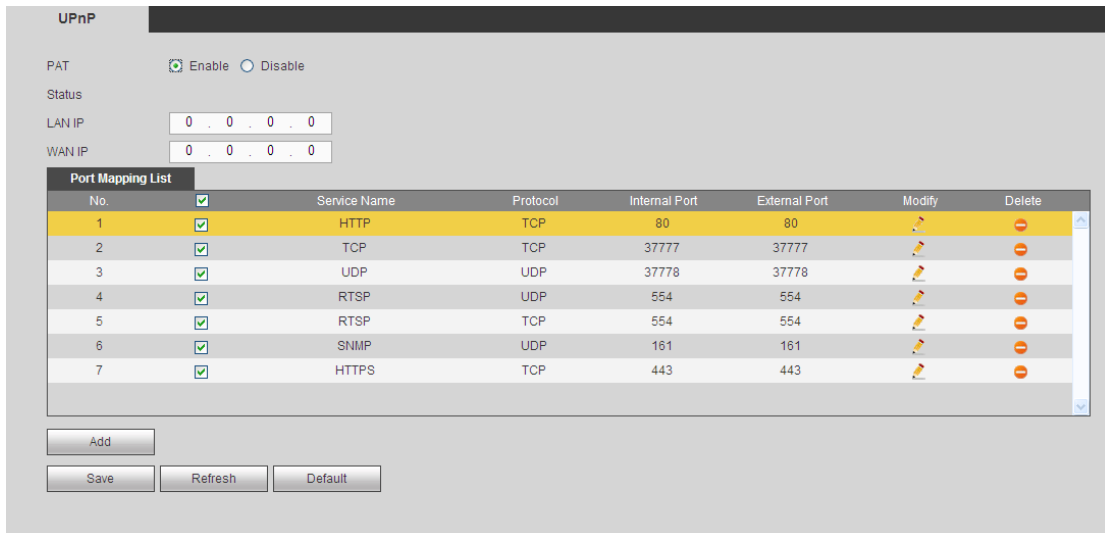

Figure 5-32

5.8.2.11 SNMP

The SNMP interface is shown as in Figure 5-33.

The SNMP allows the communication between the network management work station software and the proxy of the managed device. It is reserved for the 3rd party to develop.



Figure 5-33

Please refer to the following sheet for detailed information.

Parameter	Function
SNMP Port	The listening port of the proxy program of the device. It is a UDP port not a TCP port. The value ranges from 1 to 65535. The default value is 161
Read Community	It is a string. It is a command between the manage process and the proxy process. It defined the authentication, access control and the management relationship between one proxy and one group of the managers. Please make sure the device and the proxy are the same. The read community will read all the objects the SNMP supported in the specified name. The default setup is public.
Write Community	It is a string. It is a command between the manage process and the proxy process. It defined the authentication, access control and the management relationship between one proxy

Parameter	Function
	and one group of the managers. Please make sure the device and the proxy are the same. The read community will read/write/access all the objects the SNMP supported in the specified name. The default setup is write.
Trap address	The destination address of the Trap information from the proxy program of the device.
Trap port	The destination port of the Trap information from the proxy program of the device. It is for the gateway device and the client-end PC in the LAN to exchange the information. It is a non-protocol connection port. It has no effect on the network applications. It is a UDP port not TCP port. The value ranges from 1 to 165535. The default value is 162.
SNMP version	<ul style="list-style-type: none"> ● Check V1, system only processes the information of V1. ● Check V2, system only processes the information of V2.

5.8.2.12 Multicast

The multicast interface is shown as in Figure 5-34.

Multicast is a transmission mode of data packet. When there is multiple-host to receive the same data packet, multiple-cast is the best option to reduce the broad width and the CPU load. The source host can just send out one data to transit. This function also depends on the relationship of the group member and group of the outer.

Figure 5-34

5.8.2.13 Auto Register

The auto register interface is shown as below. See Figure 5-35.

This function allows the device to auto register to the proxy you specified. In this way, you can use the client-end to access the DVR and etc via the proxy. Here the proxy has a switch function. In the network service, device supports the server address of IPv4 or domain.

Please follow the steps listed below to use this function.

Please set proxy server address, port, and sub-device name at the device-end. Please enable the auto register function, the device can auto register to the proxy server.

Figure 5-35

5.8.2.14 Alarm Centre

The alarm centre interface is shown as below. See Figure 5-36.

This interface is reserved for you to develop. System can upload alarm signal to the alarm centre when local alarm occurs.

Before you use alarm centre, please set server IP, port and etc. When an alarm occurs, system can send out data as the protocol defined, so the client-end can get the data.

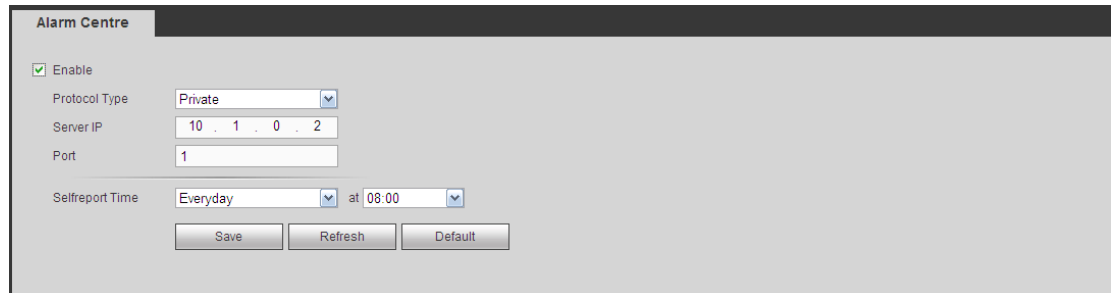

The screenshot shows the 'Alarm Centre' configuration page. It features a header 'Alarm Centre' and a list of settings: 'Enable' (checked), 'Protocol Type' (set to 'Private'), 'Server IP' (10.1.0.2), 'Port' (1), and 'Selfreport Time' (Everyday at 08:00). At the bottom, there are three buttons: 'Save', 'Refresh', and 'Default'.

Figure 5-36

5.8.2.15 HTTPS

In this interface, you can set to make sure the PC can successfully login via the HTTPS. It is to guarantee communication data security. The reliable and stable technology can secure the user information security and device safety. See Figure 5-37.

Note

- You need to implement server certificate again if you have changed device IP.
- You need to download root certificate if it is your first time to use HTTPS on current PC.



The screenshot shows the 'HTTPS' configuration page with two buttons: 'Create Server Certificate' and 'Download Root Certificate'.

Figure 5-37

5.8.2.15.1 Create Server Certificate

If it is your first time to use this function, please follow the steps listed below.

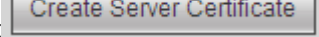
In Figure 5-37, click  button, input country name, state name and etc. Click Create button. See Figure 5-38.

Note

Please make sure the IP or domain information is the same as your device IP or domain name.

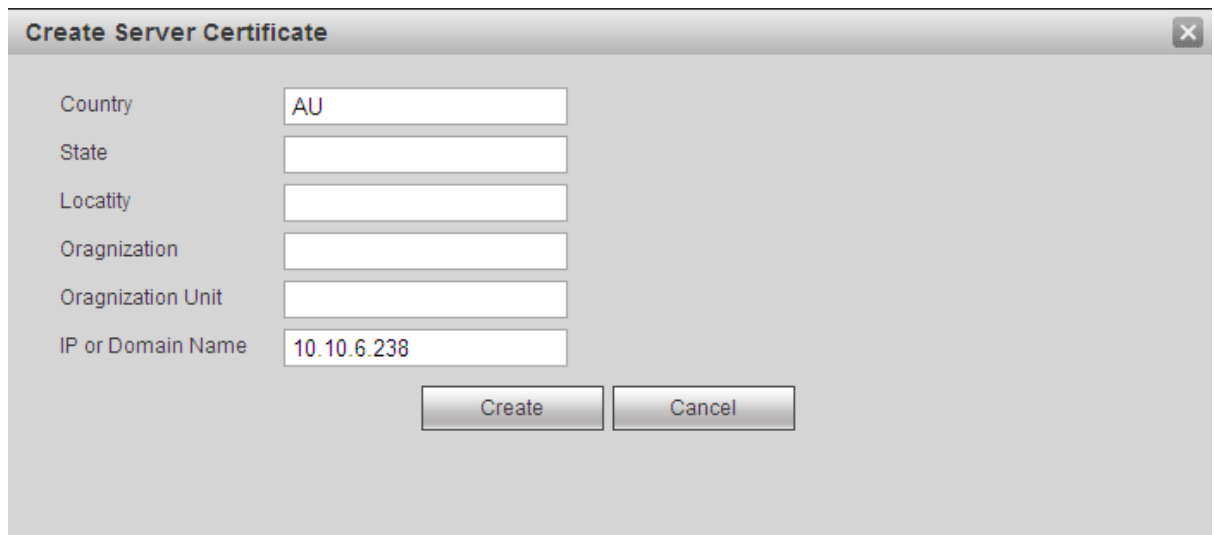

Figure 5-38

You can see the corresponding prompt. See Figure 5-39. Now the server certificate is successfully created.



Figure 5-39

5.8.2.15.2 Download root certificate

In Figure 5-37, click **Download Root Certificate** button, system pops up a dialogue box. See Figure 5-40.

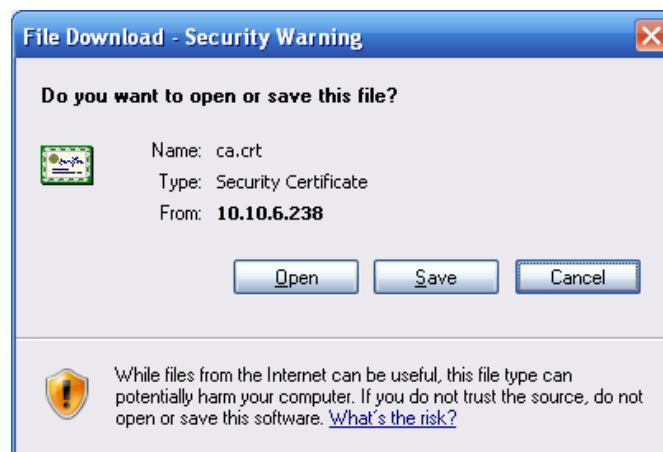

Figure 5-40

Click Open button, you can go to the following interface. See Figure 5-41.

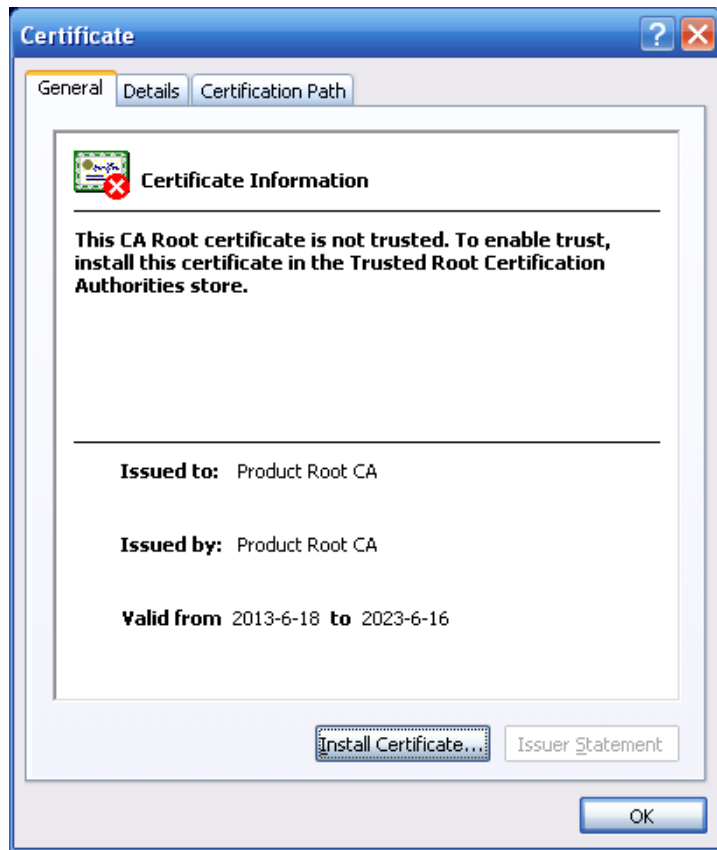

Figure 5-41

Click Install certificate button, you can go to certificate wizard. See Figure 5-42.



Figure 5-42

Click Next button to continue. Now you can select a location for the certificate. See Figure 5-43.

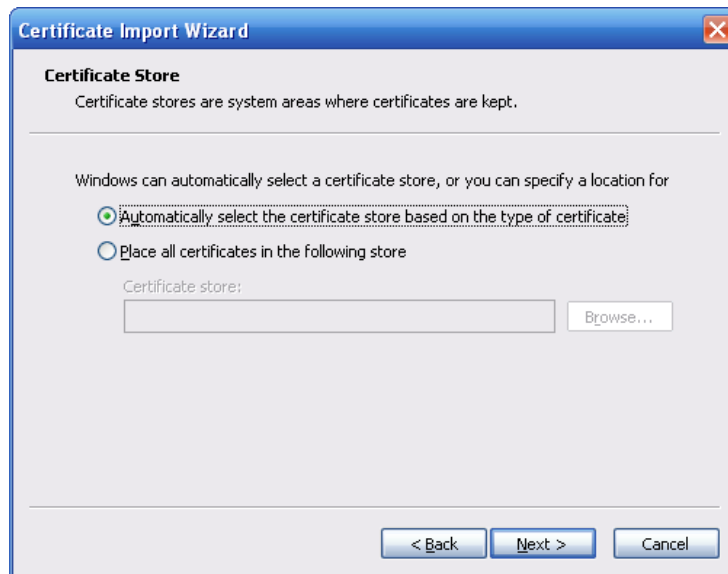

Figure 5-43

Click Next button, you can see the certificate import process is complete. See Figure 5-44.

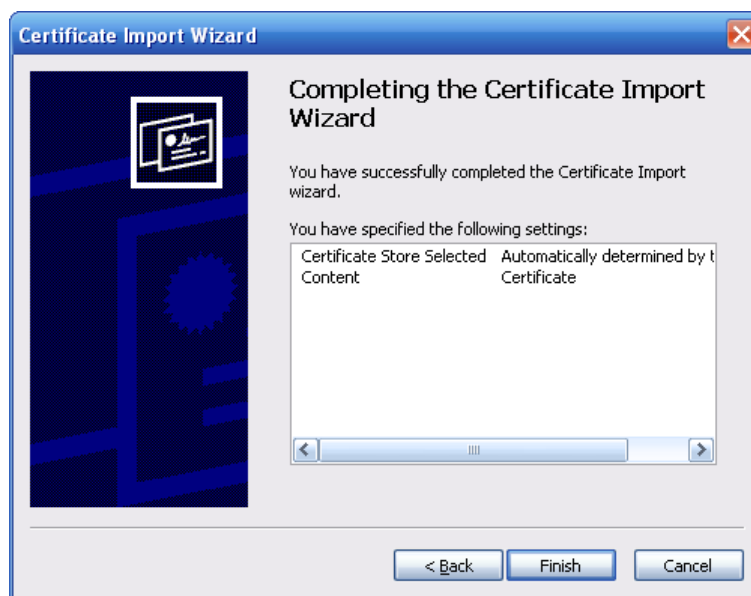

Figure 5-44

Click Finish button, you can see system pops up a security warning dialogue box. See Figure 5-45.



Figure 5-45

Click Yes button, system pops up the following dialogue box, you can see the certificate download is complete. See Figure 5-46.



Figure 5-46

5.8.2.15.3 View and set HTTPS port

From Setup->Network->Connection, you can see the following interface. See Figure 5-47. You can see HTTPS default value is 443.

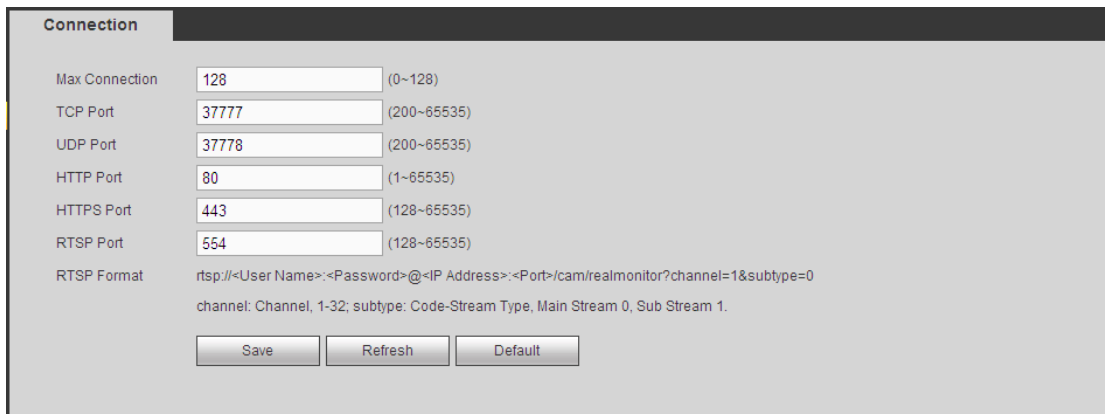

Figure 5-47

5.8.2.15.4 Login

Open the browser and then input <https://xx.xx.xx.xx:port>.

xx.xx.xx.xx: is your device IP or domain mane.

Port is your HTTPS port. If you are using default HTTPS value 443, you do not need to add port information here. You can input <https://xx.xx.xx.xx> to access.

Now you can see the login interface if your setup is right.

5.8.3 Event

5.8.3.1 Video detect

5.8.3.1.1 Motion Detect

The motion detect interface is shown as in Figure 5-48.

The screenshot shows the 'Motion Detect' configuration window. It has three tabs: 'Motion Detect', 'Video Loss', and 'Tampering'. The 'Motion Detect' tab is active. The interface includes the following settings:

- Enable:** Checked, with a dropdown menu set to '1'.
- Period:** A 'Setup' button.
- Anti-dither:** Input field '5', with 'Second(5-600)' below it.
- Region:** A 'Setup' button.
- Record Channel:** Checked, with a row of 16 numbered buttons (1-16), where button '1' is highlighted in orange.
- Delay:** Input field '10', with 'Second(10-300)' below it.
- Alarm Out:** Unchecked, with a row of 6 numbered buttons (1-6), where button '1' is highlighted in orange.
- Latch:** Input field '10', with 'Second(1-300)' below it.
- PTZ Activation:** Unchecked, with a 'Setup' button.
- Tour:** Unchecked, with a row of 16 numbered buttons (1-16), where button '1' is highlighted in orange.
- Snapshot:** Checked, with a row of 16 numbered buttons (1-16), where button '1' is highlighted in orange.
- Video Matrix:** Unchecked, with a row of 16 numbered buttons (1-16), where button '1' is highlighted in orange.
- Show Message:** Unchecked, with sub-options: Send Email, Alarm Upload, Buzzer, Message.

At the bottom, there are four buttons: 'Copy', 'Save', 'Refresh', and 'Default'.

Figure 5-48

The screenshot shows a 'Setup' dialog box with a close button (X) in the top right corner. It contains the following elements:

- A dropdown menu showing 'Thursday'.
- A 'Copy' button.
- A list of six time slots, each with a checkbox and a time range: '00 : 00 - 24 : 00'. The first slot is checked.
- 'Save' and 'Cancel' buttons at the bottom.

Figure 5-49

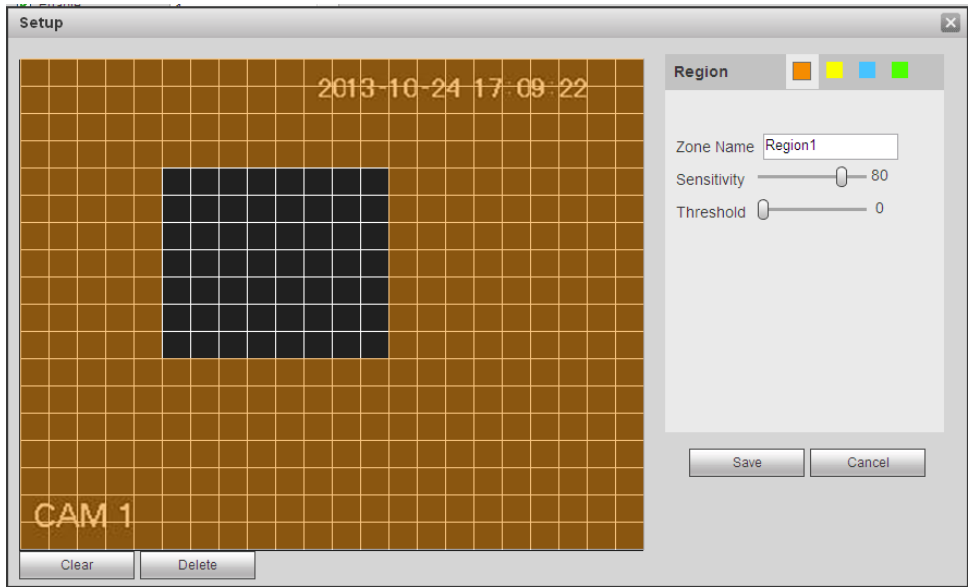

Figure 5-50

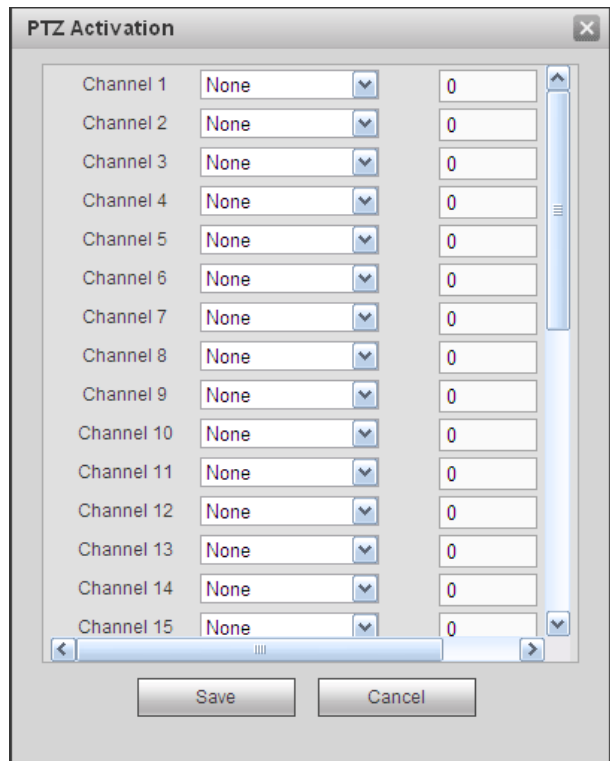

Figure 5-51

Please refer to the following sheet for detailed information.

Parameter	Function
Enable	You need to check the box to enable motion detection function. Please select a channel from the dropdown list.

Parameter	Function
Period	<p>Motion detection function becomes activated in the specified periods. See Figure 5-49.</p> <p>There are six periods in one day. Please draw a circle to enable corresponding period.</p> <p>Click OK button, system goes back to motion detection interface, please click save button to exit.</p>
Anti-dither	<p>System only memorizes one event during the anti-dither period. The value ranges from 5s to 600s.</p>
Sensitivity	<p>There are six levels. The sixth level has the highest sensitivity.</p>
Region	<p>If you select motion detection type, you can click this button to set motion detection zone. The interface is shown as in Figure 5-50. Here you can set motion detection zone. There are four zones for you to set. Please select a zone first and then left drag the mouse to select a zone. The corresponding color zone displays different detection zone. You can click Fn button to switch between the arm mode and disarm mode. In arm mode, you can click the direction buttons to move the green rectangle to set the motion detection zone. After you completed the setup, please click ENTER button to exit current setup. Do remember click save button to save current setup. If you click ESC button to exit the region setup interface system will not save your zone setup.</p>
Record channel	<p>System auto activates motion detection channel(s) to record once an alarm occurs. Please note you need to set motion detect record period and go to Storage-> Schedule to set current channel as schedule record.</p>
Record Delay	<p>System can delay the record for specified time after alarm ended. The value ranges from 10s to 300s.</p>
Alarm out	<p>Enable alarm activation function. You need to select alarm output port so that system can activate corresponding alarm device when an alarm occurs.</p>
Latch	<p>System can delay the alarm output for specified time after an alarm ended. The value ranges from 1s to 300s.</p>
Show message	<p>System can pop up a message to alarm you in the local host screen if you enabled this function.</p>
Buzzer	<p>Check the box here to enable this function. The buzzer beeps when an alarm occurs.</p>
Alarm upload	<p>System can upload the alarm signal to the centre (Including alarm centre).</p>
Message	<p>When 3G network connection is OK, system can send out a message when motion detect occurs.</p>
Send Email	<p>If you enabled this function, System can send out an email to alert you when an alarm occurs.</p>
Tour	<p>You need to check the box here to enable this function. System begins 1-window or multiple-window tour display among the channel(s) you set to record when an alarm occurs.</p>

PTZ Activation	Here you can set PTZ movement when alarm occurs. Such as go to preset X. See Figure 5-51.
Video Matrix	This function is for motion detect only. Check the box here to enable video matrix function. Right now system supports one-channel tour function. System takes “first come and first serve” principle to deal with the activated tour. System will process the new tour when a new alarm occurs after previous alarm ended. Otherwise it restores the previous output status before the alarm activation.

5.8.3.1.2 Video Loss

The video loss interface is shown as in Figure 5-52.

After analysis video, system can generate a video loss alarm when the detected moving signal reached the sensitivity you set here.

Please note video loss does not support anti-dither, sensitivity, region setup. For rest setups, please refer to chapter 5.8.3.1.1 motion detect for detailed information.

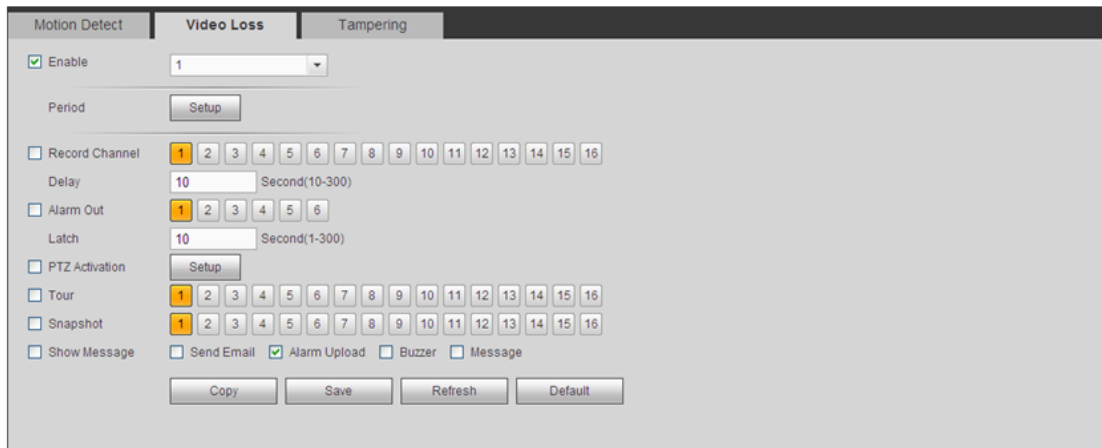

Figure 5-52

5.8.3.1.3 Tampering

The tampering interface is shown as in Figure 5-53.

After analysis video, system can generate a tampering alarm when the detected moving signal reached the sensitivity you set here.

For detailed setups, please refer to chapter 5.8.3.1.1 motion detect for detailed information.

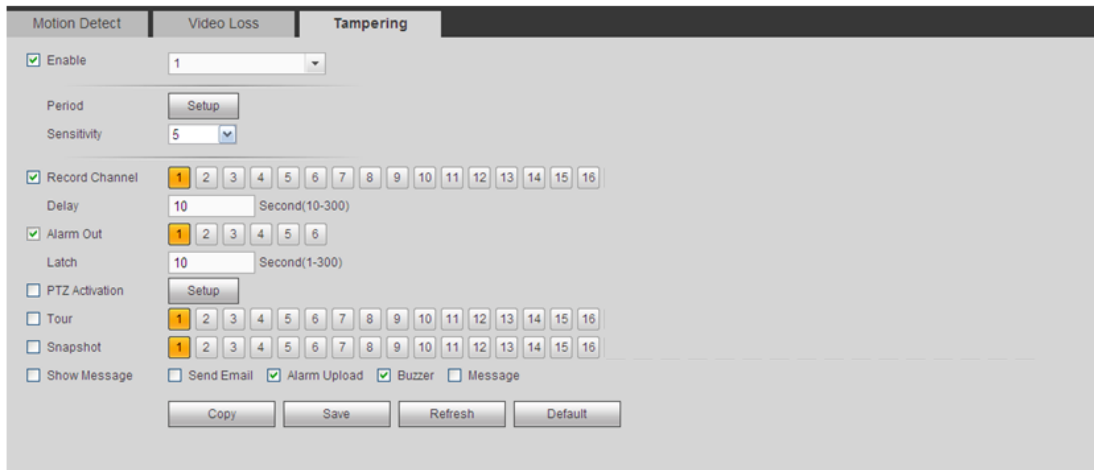

Figure 5-53

5.8.3.2 Alarm

Before operation, please make sure you have properly connected alarm devices such as buzzer. The input mode includes local alarm and network alarm.

5.8.3.2.1 Local Alarm

The local alarm interface is shown as in Figure 5-54. It refers to alarm from the local device.

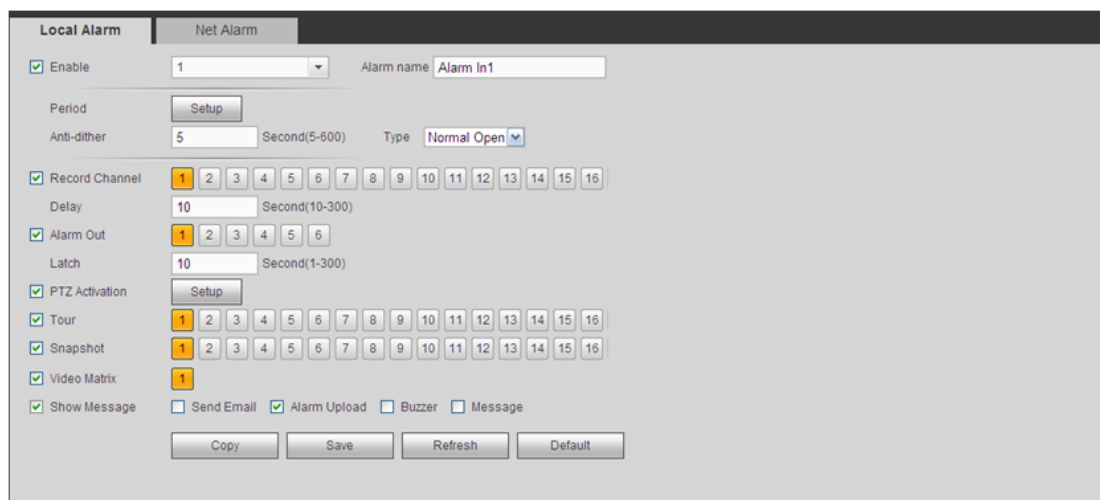

Figure 5-54

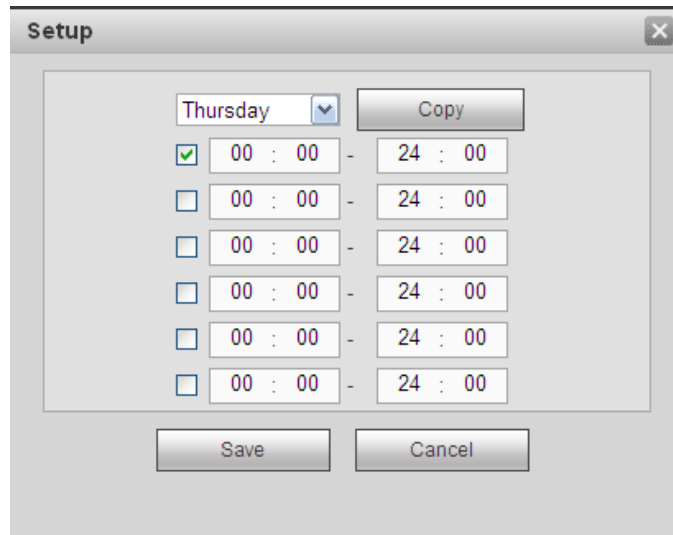

Figure 5-55

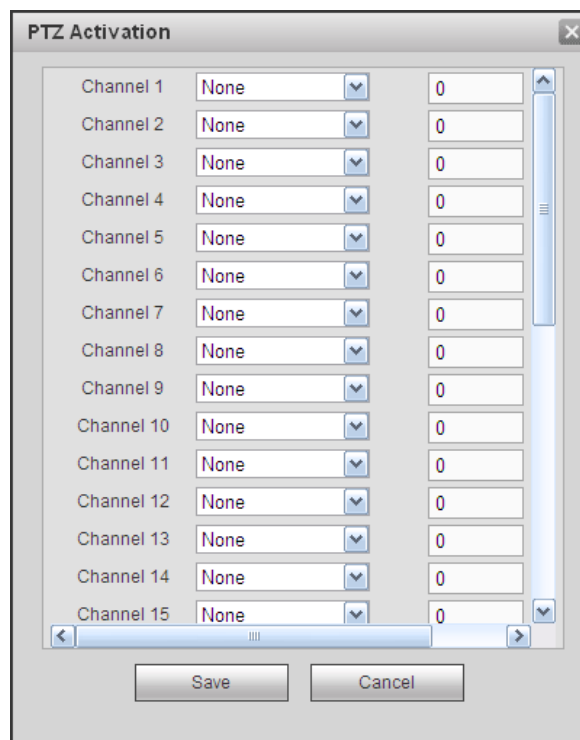

Figure 5-56

Please refer to the following sheet for detailed information.

Parameter	Function
Enable	You need to check the box to enable this function. Please select a channel from the dropdown list.
Period	This function becomes activated in the specified periods. There are six periods in one day. Please draw a circle to enable corresponding period. Select date. If you do not select, current setup applies to today only. You can select all week column to apply to the

Parameter	Function
	whole week. Click OK button, system goes back to local alarm interface, please click save button to exit.
Anti-dither	System only memorizes one event during the anti-dither period. The value ranges from 5s to 600s.
Sensor type	There are two options: NO/NC.
Record channel	System auto activates motion detection channel(s) to record once an alarm occurs. Please note you need to set alarm record period and go to Storage-> Schedule to set current channel as schedule record.
Record Delay	System can delay the record for specified time after alarm ended. The value ranges from 10s to 300s.
Alarm out	Enable alarm activation function. You need to select alarm output port so that system can activate corresponding alarm device when an alarm occurs.
Latch	System can delay the alarm output for specified time after an alarm ended. The value ranges from 1s to 300s.
Show message	System can pop up a message to alarm you in the local host screen if you enabled this function.
Buzzer	Check the box here to enable this function. The buzzer beeps when an alarm occurs.
Alarm upload	System can upload the alarm signal to the centre (Including alarm centre).
Send Email	If you enabled this function, System can send out an email to alert you when an alarm occurs.
Tour	You need to check the box here to enable this function. System begins 1-window or multiple-window tour display among the channel(s) you set to record when an alarm occurs.
PTZ Activation	Here you can set PTZ movement when alarm occurs. Such as go to preset X.

5.8.3.2.2 Net Alarm

The network alarm interface is shown as in Figure 5-57.

Network alarm refers to the alarm signal from the network. System does not anti-dither and sensor type setup. For setup information, please refer to chapter 5.8.3.2.1.

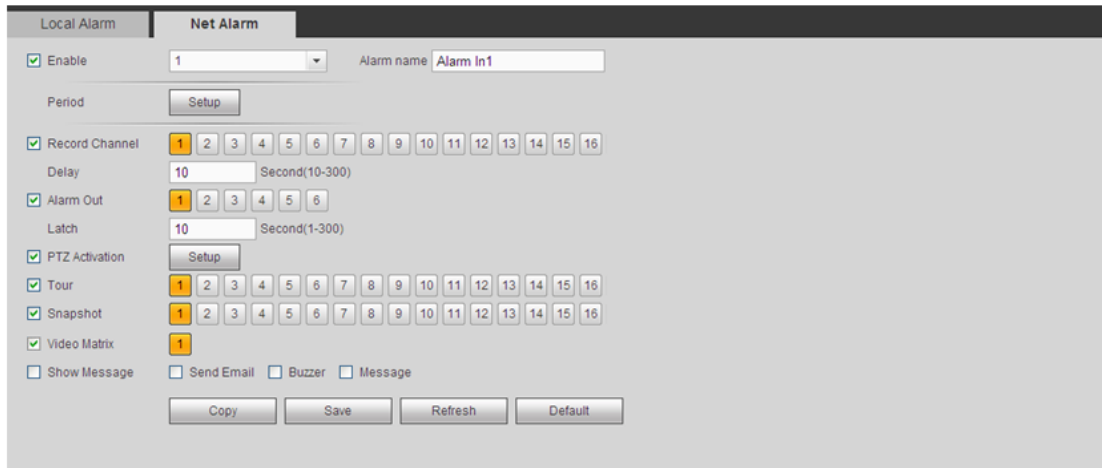

Figure 5-57

5.8.3.3 Alarm Output

It is to set alarm output mode. See Figure 5-58.

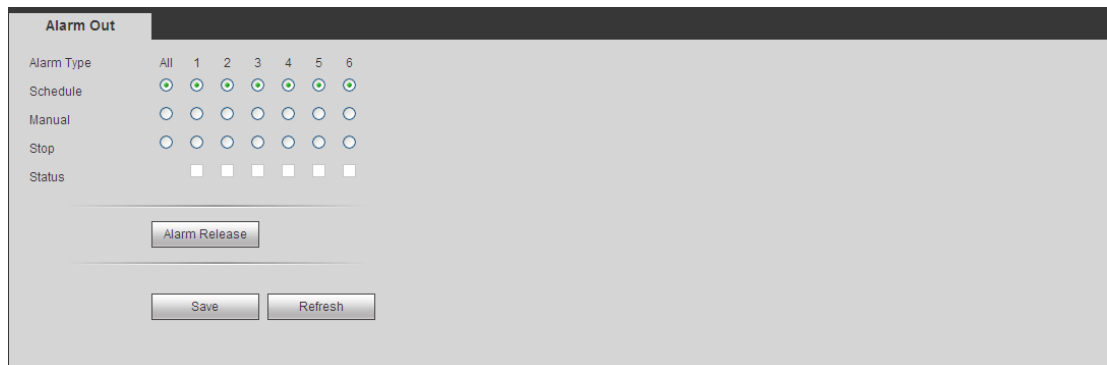

Figure 5-58

5.8.3.4 Abnormality

It includes two types: No disk, disk error, disk no space, net disconnection, IP conflict and MAC conflict. See Figure 5-59 and Figure 5-60.

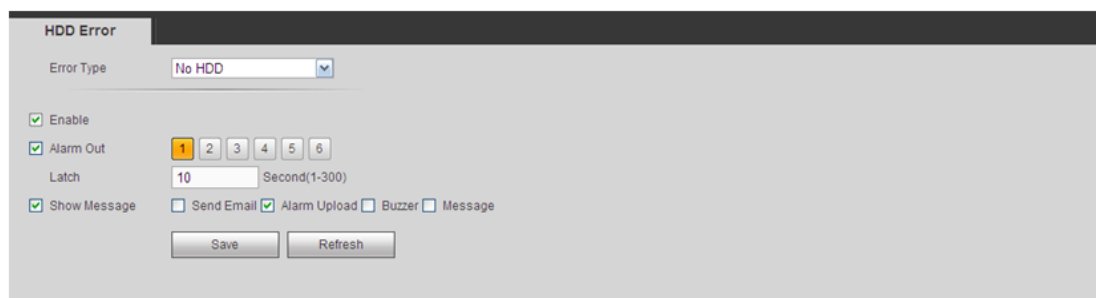

Figure 5-59

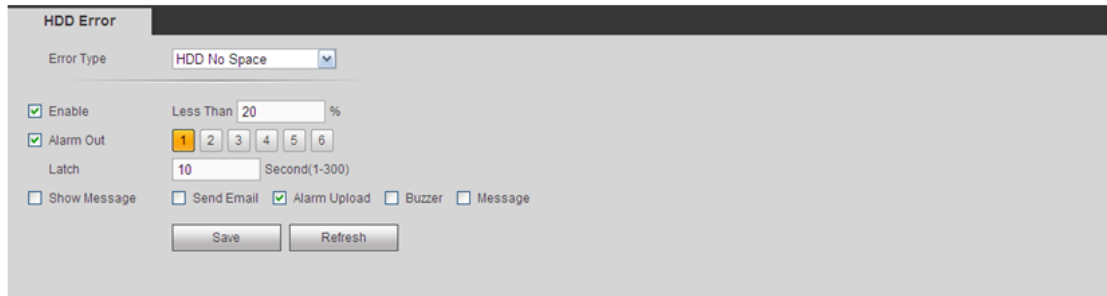

Figure 5-60

Please refer to the following sheet for detailed information.

Parameter	Function
Event Type	The abnormal events include: No disk, disk error, disk no space, net disconnection, IP conflict and MAC conflict. You can set one or more items here. Less than: You can set the minimum percentage value here (For disk not space only). The device can alarm when capacity is not sufficient. You need to draw a circle to enable this function.
Enable	Check the box here to enable selected function.
Alarm Out	Please select corresponding alarm output channel when an alarm occurs. You need to check the box to enable this function.
Latch	The alarm output can delay for the specified time after an alarm stops. The value ranges from 1s to 300s.
Show message	System can pop up a message to alarm you in the local host screen if you enabled this function.
Alarm upload	System can upload the alarm signal to the centre (Including alarm centre).
Send Email	If you enabled this function, System can send out an email to alert you when an alarm occurs.
Buzzer	Check the box here to enable this function. The buzzer beeps when an alarm occurs.

5.8.4 Storage

5.8.4.1 Schedule

In this interfaces, you can add or remove the schedule record setup. See Figure 5-61.

There are three record modes: general (auto), motion detect and alarm. There are six periods in one day.

You can view the current time period setup from the color bar.

- Green color stands for the general record/snapshot.
- Yellow color stands for the motion detect record/snapshot..
- Red color stands for the alarm record/snapshot.
- Blue color stands for MD&alarm record/snapshot.

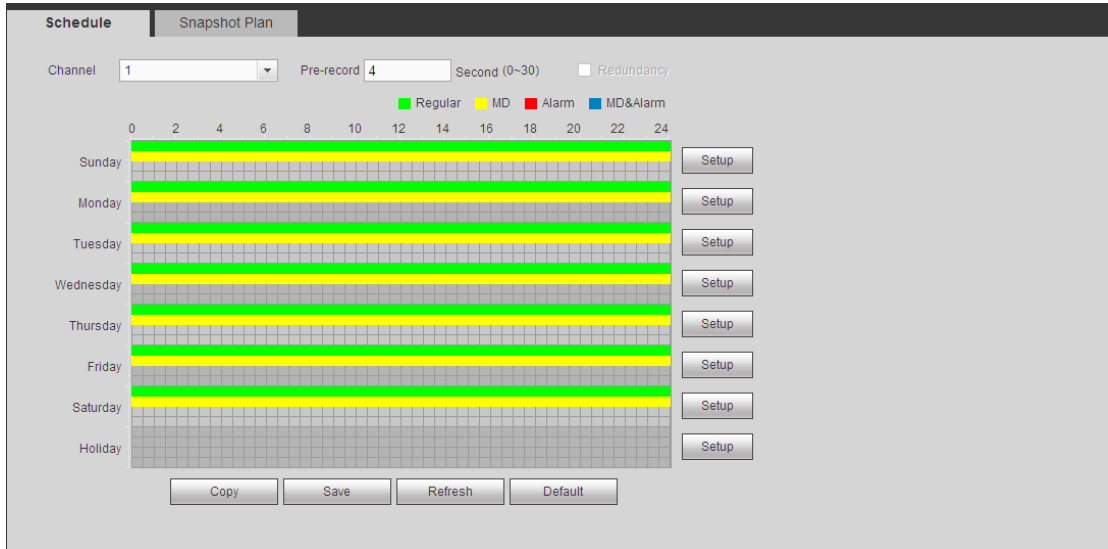

Figure 5-61

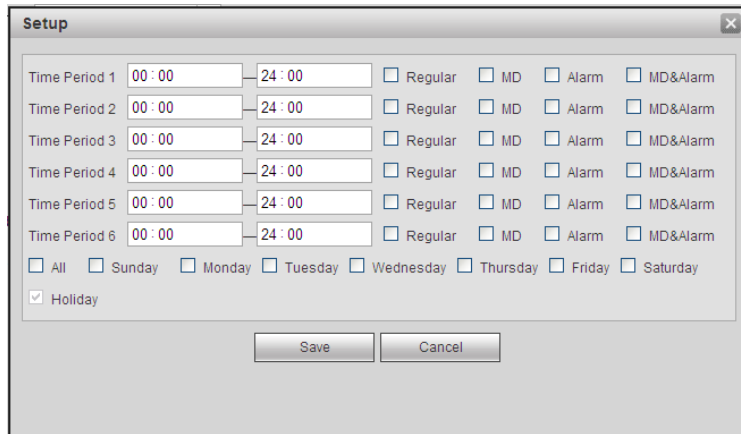

Figure 5-62

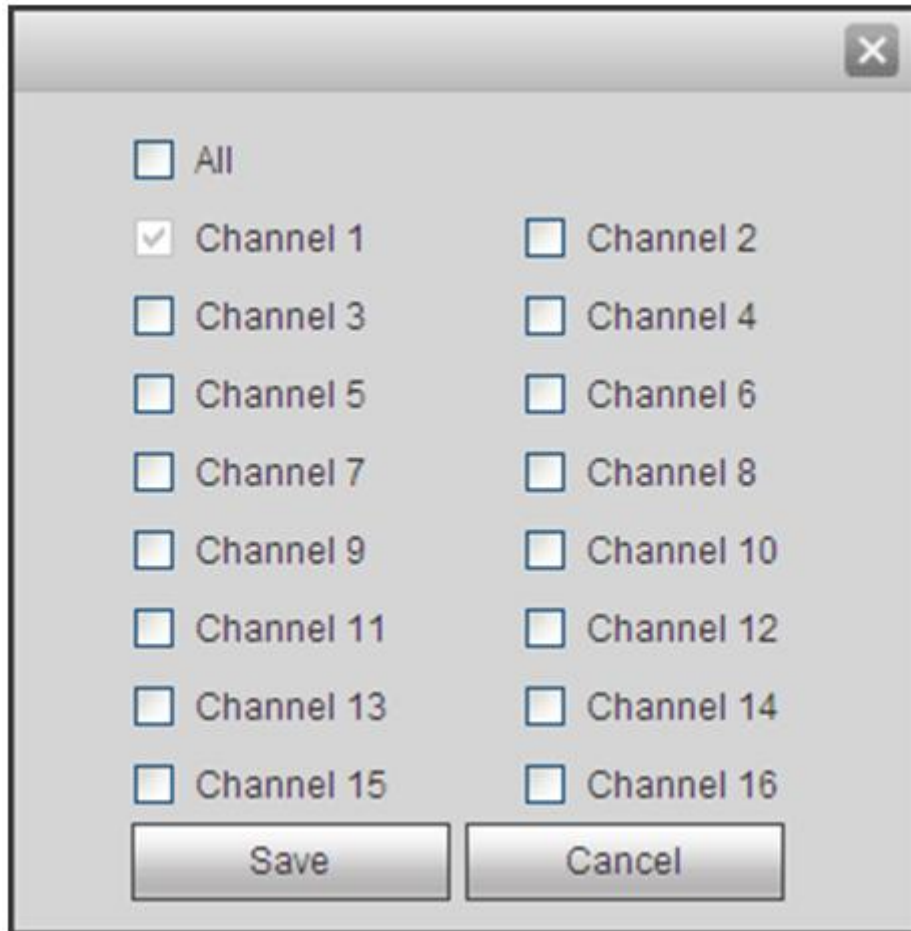

Figure 5-63

Please refer to the following sheet for detailed information.

Parameter	Function
Channel	Please select a channel from the dropdown list.
Pre-record	Please input pre-record time here. The value ranges from 0 to 30.
Redundancy	Check the box here to enable redundancy function. Please note this function is null if there is only one HDD.
Snapshot	Check the box here to enable snapshot function.
Holiday	Check the box here to enable holiday function.
Setup (Sunday to Saturday)	Click the Setup button, you can set record period. See Figure 5-62. There are six periods in one day. If you do not check the date at the bottom of the interface, current setup is for today only. Please click Save button and then exit.
Setup (Holiday)	Click the Setup button, you can set record period. See Figure 5-62. There are six periods in one day. If you check Holiday box, current channel shall record as your holiday setup here.
Copy	Copy function allows you to copy one channel setup to another. After setting in channel, click Copy button, you can go to interface Figure 5-63. You can see current channel name is grey such as channel 1.

Parameter	Function
	Now you can select the channel you want to paste such as channel 5/6/7. If you want to save current setup of channel 1 to all channels, you can click the first box "ALL". Click the OK button to save current copy setup. Click the OK button in the Encode interface, the copy function succeeded.

5.8.4.2 Local Storage

The local interface is shown as in Figure 5-64. Here you can see HDD information. You can also operate the read-only, read-write, redundancy (if there are more than on HDD) and format operation.

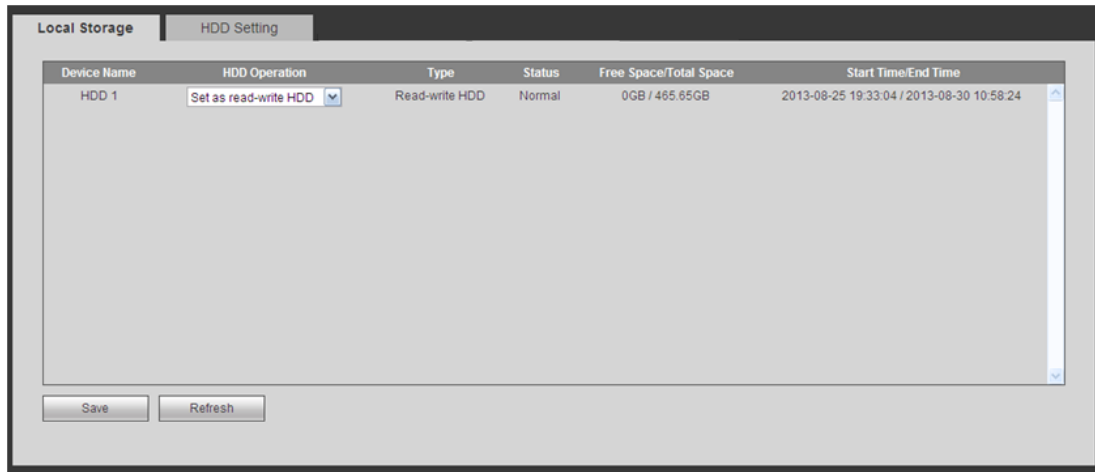

Figure 5-64

5.8.4.2.1 HDD Setting

Here is for you to set HDD group. See Figure 5-65.

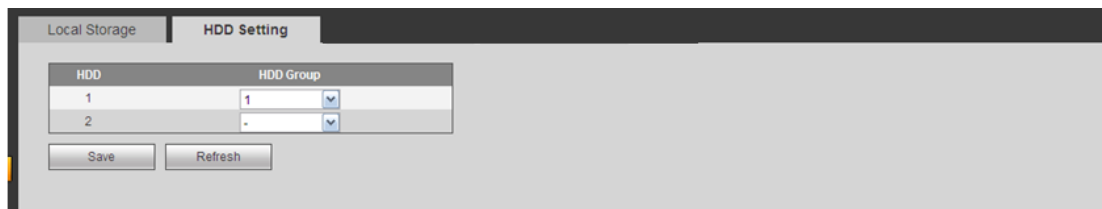

Figure 5-65

5.8.4.3 Manual Record

The interface is shown as in Figure 5-66.

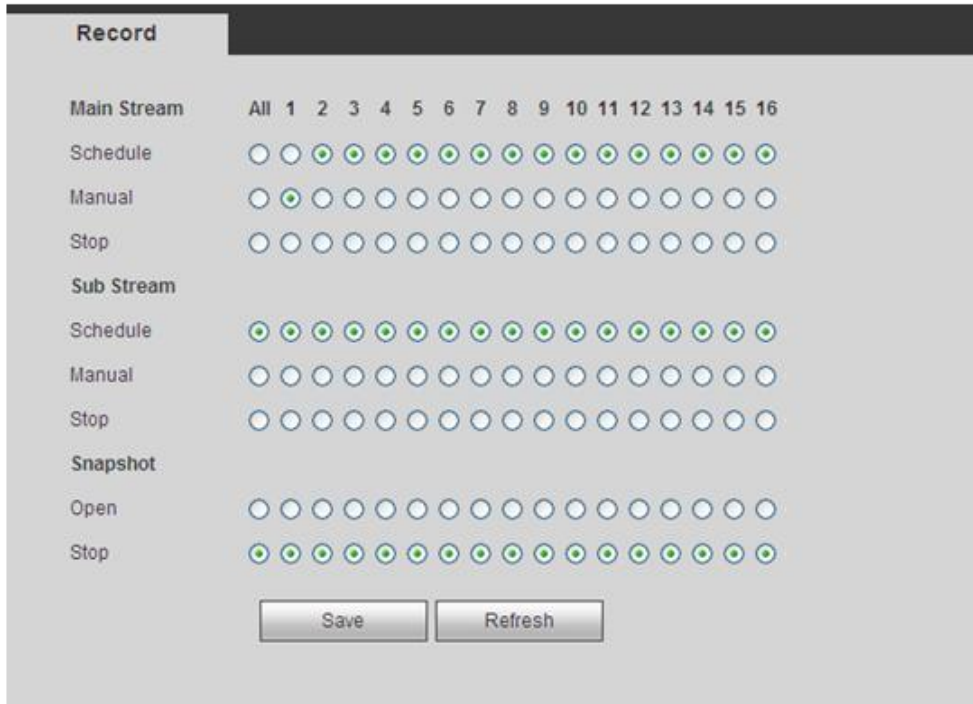

Figure 5-66

Please refer to the following sheet for detailed information.

Parameter	Function
Channel	Here you can view channel number. The number displayed here is the max channel amount of your device.
Status	There are three statuses: schedule, manual and stop.
Schedule	System enables auto record function as you set in record schedule setup (general, motion detect and alarm).
Manual	It has the highest priority. Enable corresponding channel to record no matter what period applied in the record setup.
Stop	Stop current channel record no matter what period applied in the record setup.
Start all/ stop all	Check the corresponding All button, you can enable or disable all channels record.

5.8.4.4 Advanced

5.8.4.4.1 Main Stream

The main stream interface is shown as in Figure 5-67. Here you can set corresponding HDD group to save main stream.

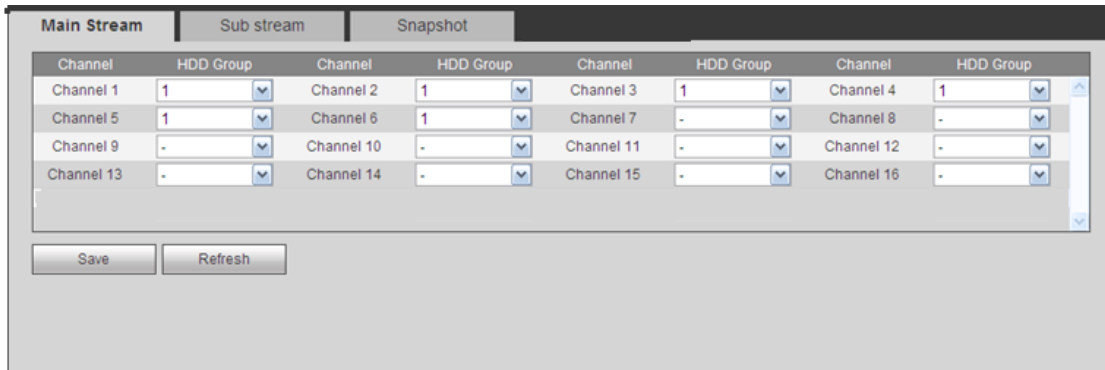

Figure 5-67

5.8.4.4.2 Sub Stream

The sub stream interface is shown as in Figure 5-68.

Here you can set corresponding HDD group to save sub stream.

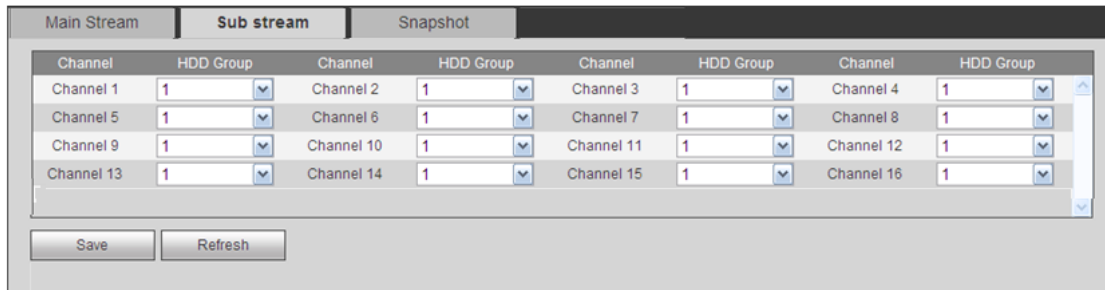

Figure 5-68

5.8.4.4.3 Snapshot

The snapshot interface is shown as in Figure 5-69. Here you can set corresponding HDD group to save snapshot picture.

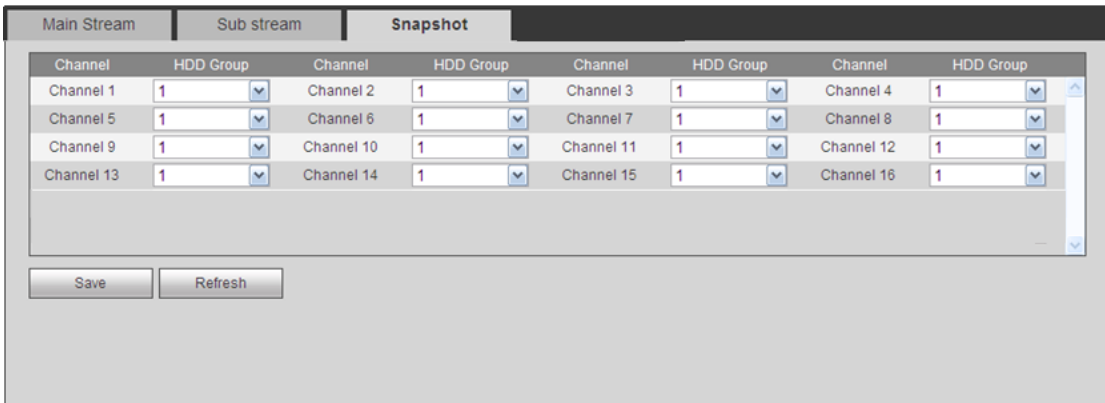

Figure 5-69

5.8.5 Setting

5.8.5.1 General

The general interface includes general, date/time and holiday setup.

5.8.5.1.1 General

The general interface is shown as in Figure 5-70.

Figure 5-70

Please refer to the following sheet for detailed information.

Parameter	Function
Device ID	It is to set device name.
Device No.	It is device channel number.
Language	You can select the language from the dropdown list. Please note the device needs to reboot to get the modification activated.
Video Standard	This is to display video standard such as PAL.
HDD full	Here is for you to select working mode when hard disk is full. There are two options: stop recording or rewrite. If current working HDD is overwritten or the current HDD is full while the next HDD is no empty, then system stops recording, If the current HDD is full and then next HDD is not empty, then system overwrites the previous files.
Pack duration	Here is for you to specify record duration. The value ranges from 1 to 120 minutes. Default value is 60 minutes.

5.8.5.1.2Date and time

The date and time interface is shown as in Figure 5-71

Figure 5-71

Please refer to the following sheet for detailed information.

Parameter	Function
Date format	Here you can select date format from the dropdown list.
Time Format	There are two options: 24-H and 12-H.
Time zone	The time zone of the device.
System time	It is to set system time. It becomes valid after you set.
Sync PC	You can click this button to save the system time as your PC current time.
DST	Here you can set day night save time begin time and end time. You can set according to the date format or according to the week format.
NTP	You can check the box to enable NTP function.
NTP server	You can set the time server address.
Port	It is to set the time server port.
Interval	It is to set the sync periods between the device and the time server.

5.8.5.1.3 Holiday Setup

Holiday setup interface is shown as in Figure 5-72.

Here you can click Add box to add a new holiday and then click Save button to save.

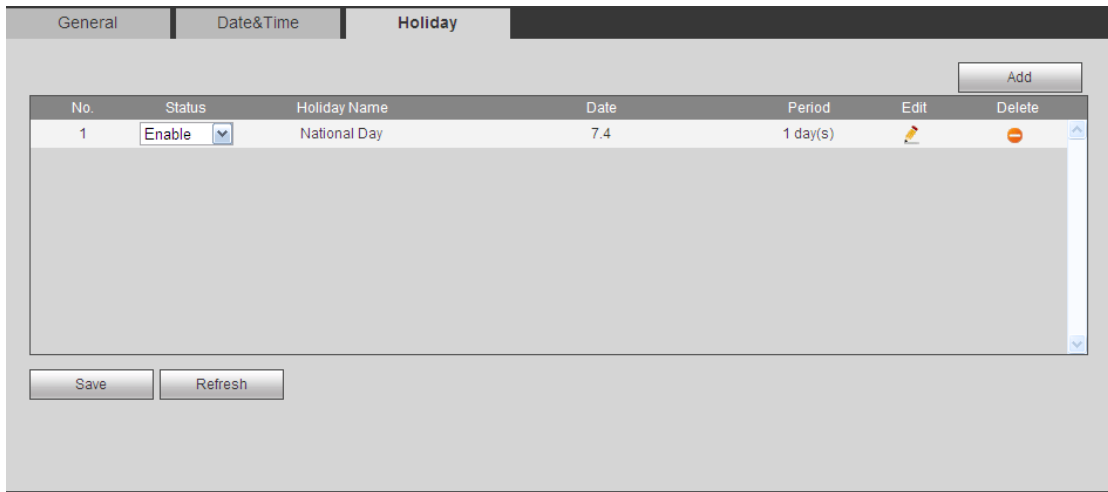

Figure 5-72

5.8.5.2 Display

Display interface includes GUI, TV adjust, Tour and zero-channel encoding.

5.8.5.2.1 GUI

Here you can set background color and transparency level. See Figure 5-73.

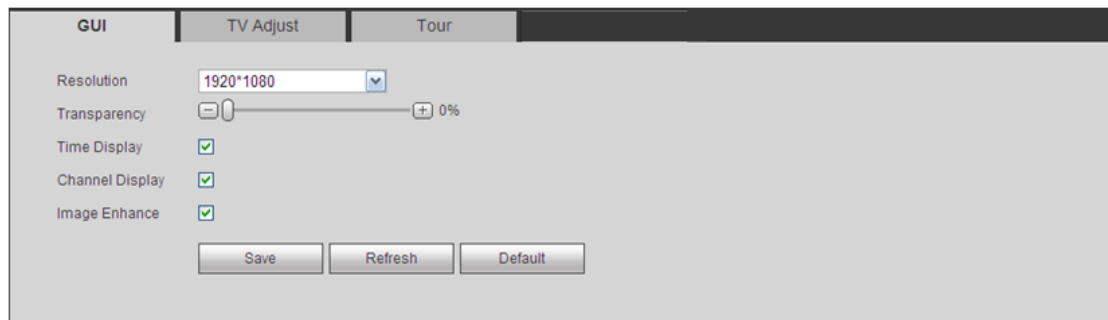

Figure 5-73

Please refer to the following sheet for detailed information.

Parameter	Function
Resolution	There are four options: 1920×1080,1280 × 1024(default),1280 × 720,1024 × 768. Please note the system needs to reboot to activate current setup.
Transparency	Here is for you to adjust transparency. The value ranges from 128 to 255.
Time title/channel title	Check the box here, you can view system time and channel number on the monitor video.
Image enhance	Check the box; you can optimize the margin of the preview video.

5.8.5.2.2 TV Adjust

It is to set TV output region. See Figure 5-74.

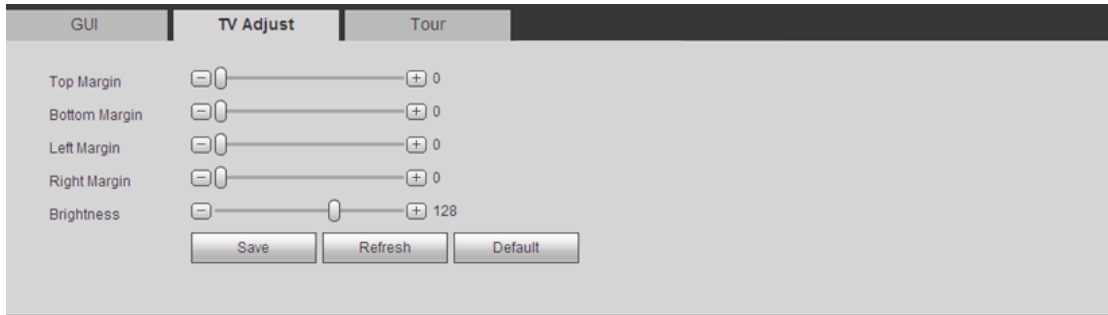

Figure 5-74

5.8.5.2.3 Tour

The tour interface is shown as in Figure 5-75. Here you can set tour interval, split mode, motion detect tour and alarm tour mode.

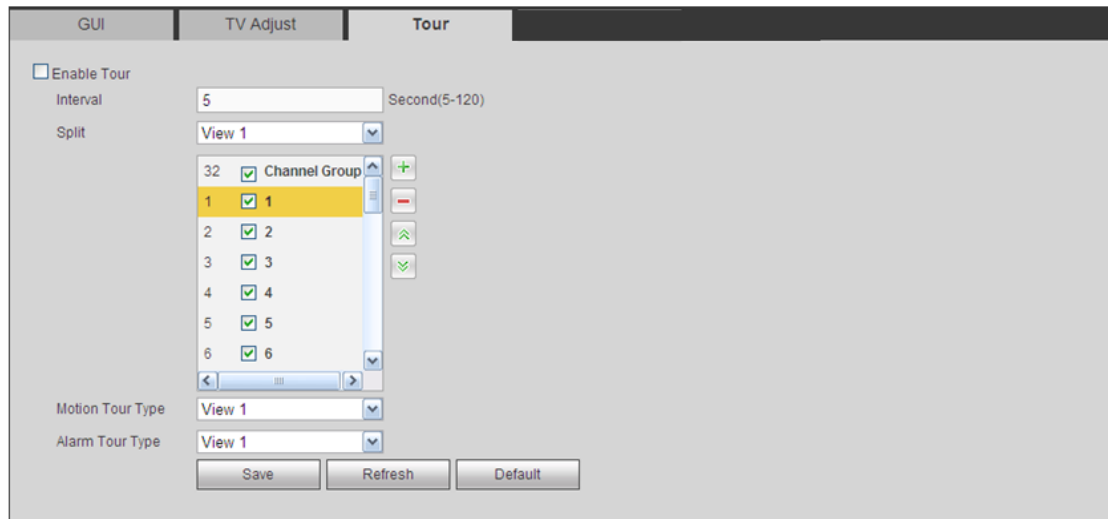

Figure 5-75

Please refer to the following sheet for detailed information.

Parameter	Function
Enable tour	Check the box here to enable tour function.
Interval	Here is for you to adjust transparency. The value ranges from 5 to 120s. The default setup is 5s.
Split	Here you can set window mode and channel group. System can support 1/4/8/9/16/25/36-window according to device channel amount.
Motion tour/Alarm tour	Here you can set motion detect tour/alarm tour window mode. System supports 1/8-window now.

5.8.5.3 Video Matrix

The interface is shown as in Figure 5-76.

Here you can set video output channel and interval. It supports 1/4 spot tour.

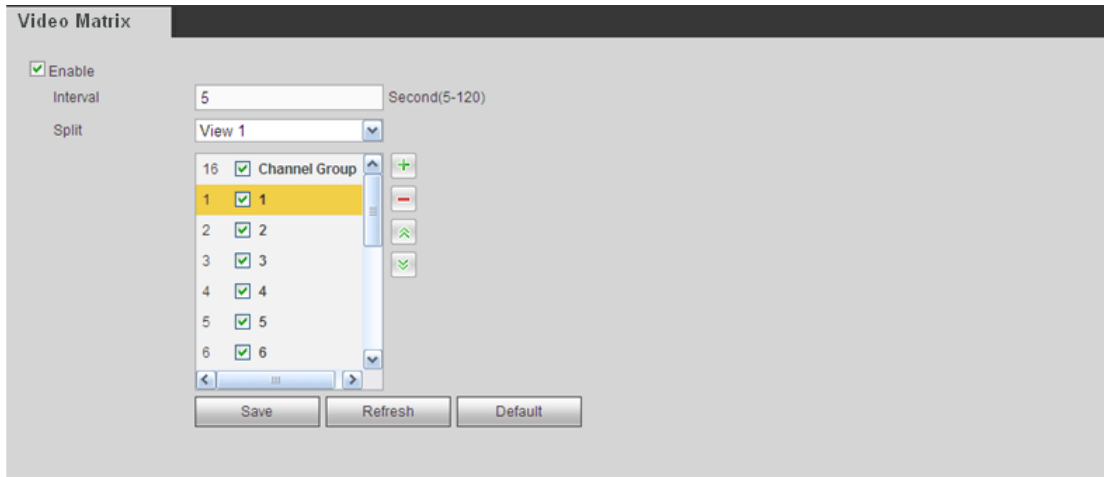

Figure 5-76

5.8.5.4 RS232

The RS232 interface is shown as in Figure 5-77.

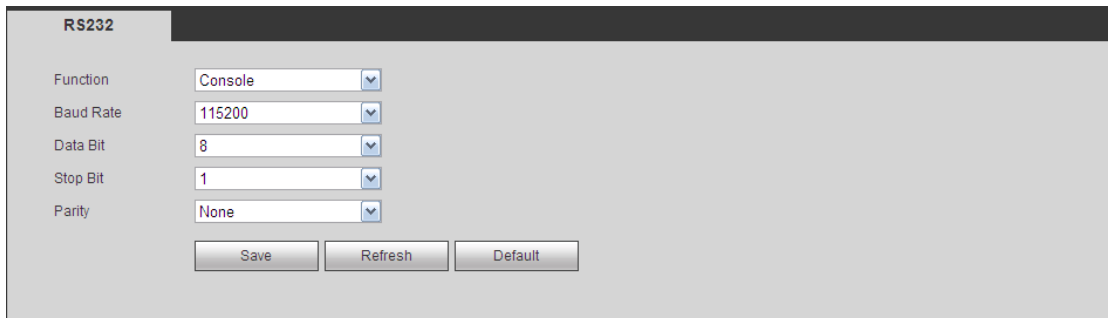

Figure 5-77

Please refer to the following sheet for detailed information.

Parameter	Function
Protocol	Select the corresponding dome protocol. Default setup is console.
Baud Rate	Select the baud rate. Default setup is 115200.
Data Bit	The value ranges from 5 to 8. Default setup is 8.
Stop bit	There are two options: 1/2. Default setup is 1.
Parity	There are five options: none/odd/even/space/mark. Default setup is none.

5.8.5.5 PTZ

The PTZ interface is shown as in Figure 5-78.

Before setup, please check the following connections are right:

- PTZ and decoder connection is right. Decoder address setup is right.
- Decoder A (B) line connects with DVR A (B) line.

Click Save button after you complete setup, you can go back to the monitor interface to control speed dome.

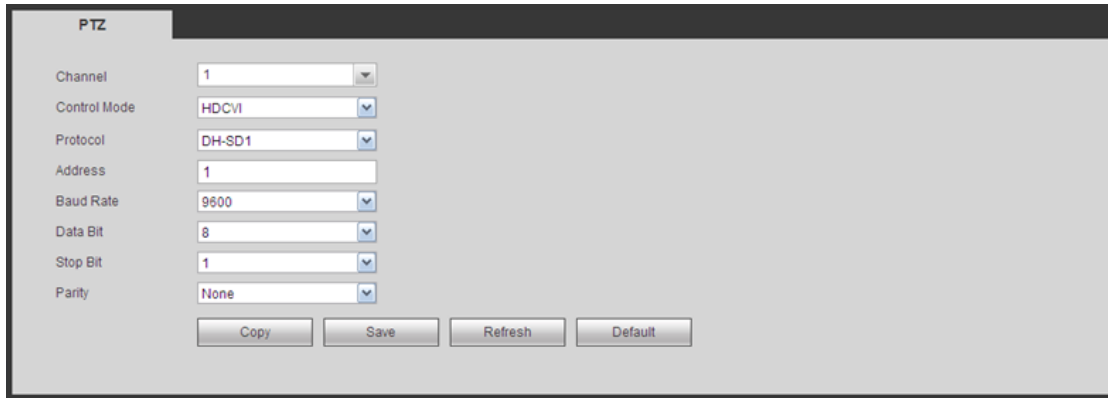

Figure 5-78

Please refer to the following sheet for detailed information.

Parameter	Function
Channel	Select speed dome connected channel.
Control mode	You can select control mode from the dropdown list. There are two options: Serial/HDCVI. For HDCVI series product, please select HDCVI. The control signal is sent to the PTZ via the coaxial cable. For the serial mode, the control signal is sent to the PTZ via the RS485 port.
Protocol	Please select protocol as DH-SD1 if you are using HDCVI mode.
Address	Set corresponding dome address. Default value is 1. Please note your setup here shall comply with your dome address; otherwise you can not control the speed dome.
Baud Rate	Select the dome baud rate. Default setup is 9600.
Data Bit	Default setup is 8. Please set according to the speed dome dial switch setup.
Stop bit	Default setup is 1. Please set according to the speed dome dial switch setup.
Parity	Default setup is none. Please set according to the speed dome dial switch setup.

5.8.5.6 ATM/POS

The ATM/POS function is for financial areas. It includes Sniffer, information analysis and title overlay function. The Sniffer mode includes COM and network.

5.8.5.6.1 COM Type

The COM interface is shown as below. See Figure 5-79.

- Protocol: Please select from the dropdown list according to your actual situation.
- Overlay channel: Please select the channel you want to overlay the card number.

- Overlay mode: There are two options: preview and encode. Preview means overlay the card number in the local monitor video. Encode means overlay the card number in the record file.
- Overlay Position: Here you can select the proper overlay position from the dropdown list.

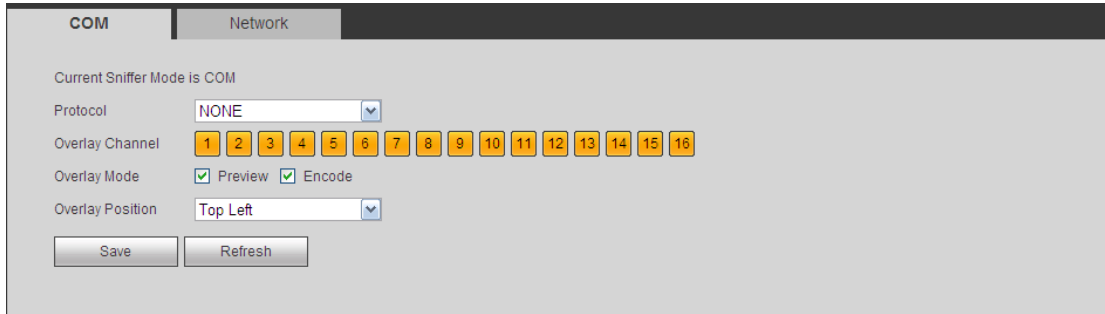

Figure 5-79

5.8.5.6.2 Network Type

The network type interface is shown as below. See Figure 5-80.

Here we take the ATM/POS protocol to continue.

There are two types: with or without the protocol according to client's requirements.

With the protocol

For ATM/POS with the protocol, you just need to set the source IP, destination IP (sometimes you need to input corresponding port number).

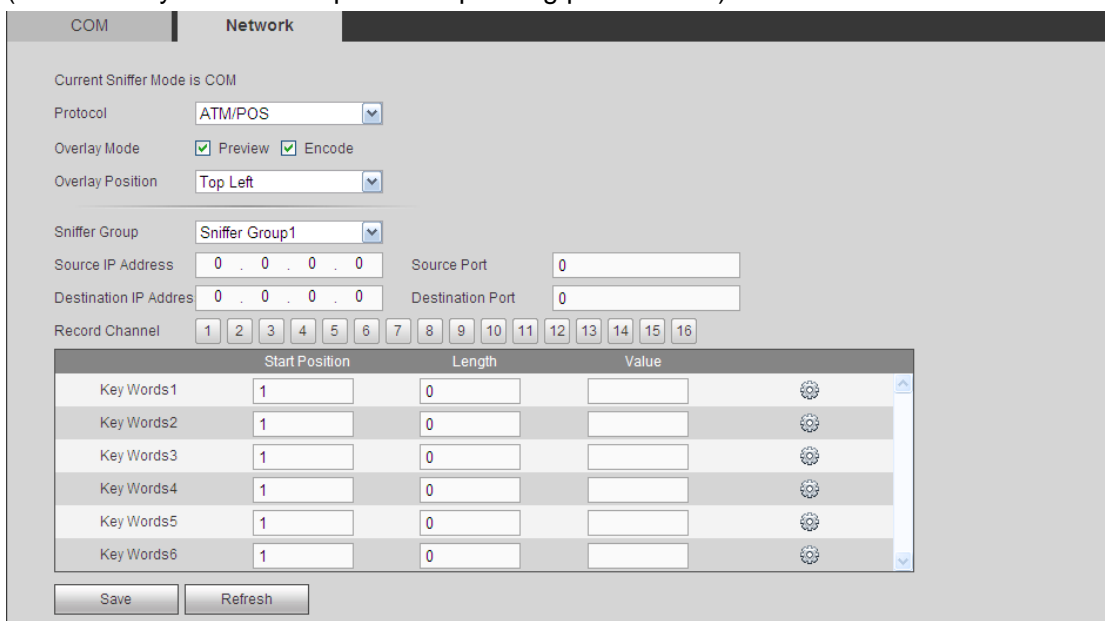

Figure 5-80

Without the protocol

For the ATM/POS without the protocol, the interface is shown as in Figure 5-81.

Source IP refers to host IP address that sends out information (usually it is the device host.)

Destination IP refers to other systems that receive information.

Usually you do not need to set source port and target port.
 There are total four groups IP. The record channel applies to one group (optional) only.
 Six frame ID groups verification can guarantee information validity and legal.

Figure 5-81

5.8.5.7 Account

Note:

- For the character in the following user name or the user group name, system max supports 6-digits. The space in the front or at the end of the string is null. The valid string includes: character, number, and underline.
- The user amount default setup is 64 and the group amount default setup is 20. The factory default setup includes two levels: user and admin. You can set the corresponding group and then set the rights for the respective user in the specified groups.
- User management adopts group/user modes. The user name and the group name shall be unique. One user shall be included in only one group.

5.8.5.7.1 User name

In this interface you can add/remove user and modify user name. See Figure 5-82.

SN	User Name	Group Name	User MAC	Memo	Modify	Delete
1	666666	user		666666 user's account		
2	admin	admin		admin 's account		
3	default	user		default account		
4	uu	admin				
5	888888	admin		admin(888) 's account		

Authority

Disconnect

Add User

Figure 5-82

Add user: It is to add a name to group and set the user rights. See Figure 5-83. There are four default users: admin/888888/666666 and hidden user “default”. Except user 6666, other users have administrator right. The user 666666 can only have the monitor rights,.

Hidden user “default” is for system interior use only and can not be deleted. When there is no login user, hidden user “default” automatically login. You can set some rights such as monitor for this user so that you can view some channel view without login. Here you can input the user name and password and then select one group for current user.

Please note the user rights shall not exceed the group right setup. For convenient setup, please make sure the general user has the lower rights setup than the admin.

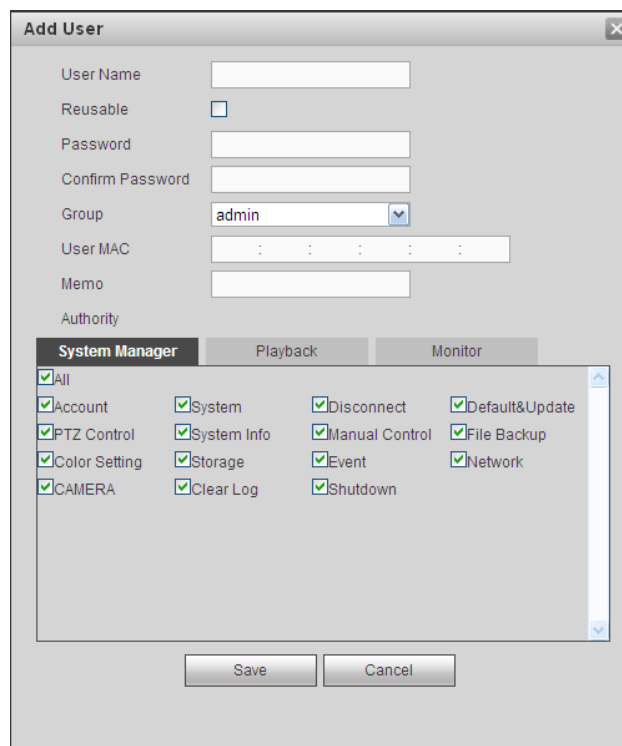

Figure 5-83

Modify user

It is to modify the user property, belonging group, password and rights. See Figure 5-84.

Modify password

It is to modify the user password. You need to input the old password and then input the new password twice to confirm the new setup. Please click the OK button to save.

Please note, the password ranges from 1-digit to 6-digit. It shall include the number only. For the user of the account rights, he can modify the password of other users.

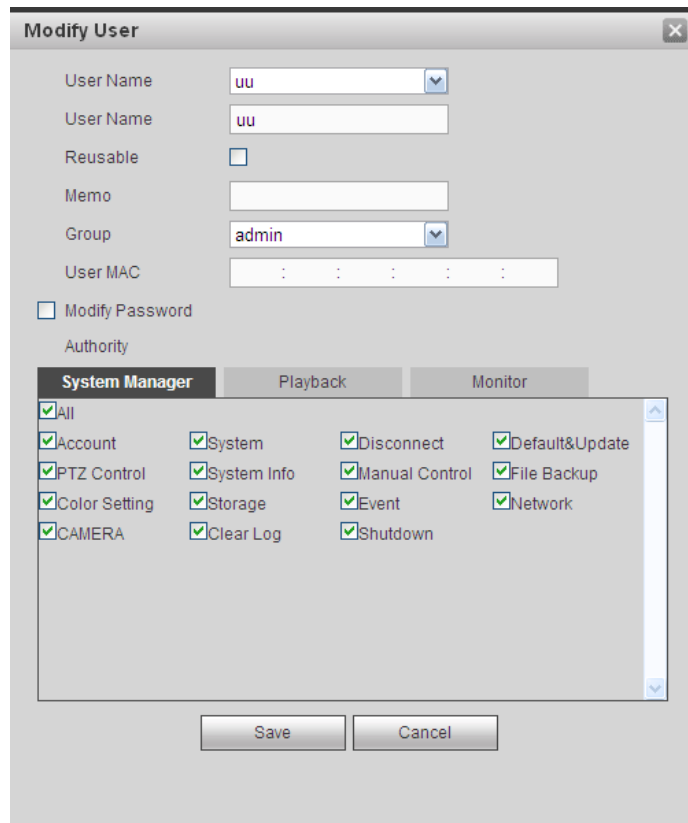

Figure 5-84

5.8.5.7.2 Group

The group management interface can add/remove group, modify group password and etc. The interface is shown as in Figure 5-85.

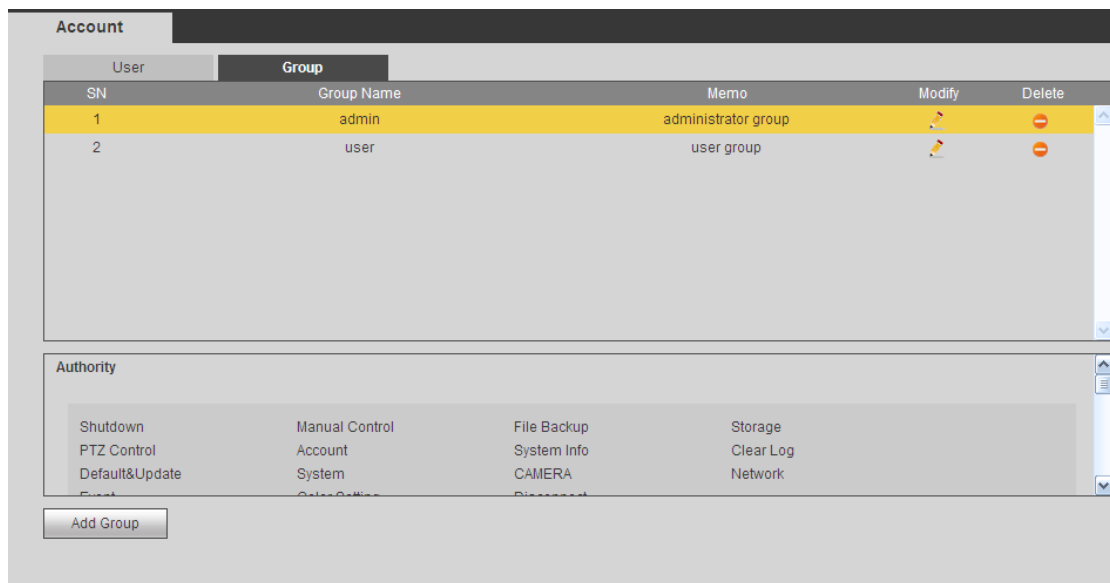

Figure 5-85

Add group: It is to add group and set its corresponding rights. See Figure 5-86. Please input the group name and then check the box to select the corresponding rights. It

includes: shutdown/reboot device, live view, record control, PTZ control and etc.

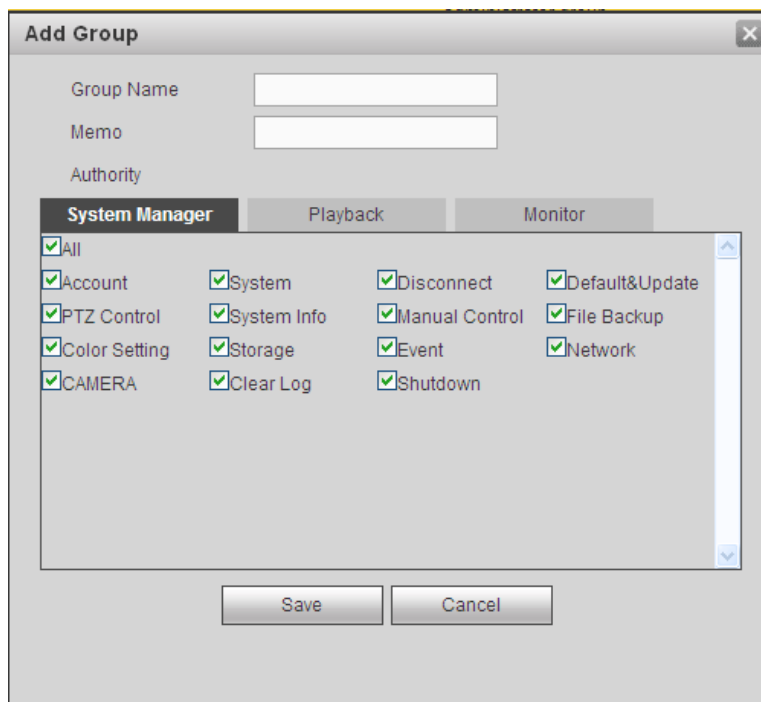

Figure 5-86

Modify group

Click the modify group button, you can see an interface is shown as in Figure 5-87. Here you can modify group information such as remarks and rights.

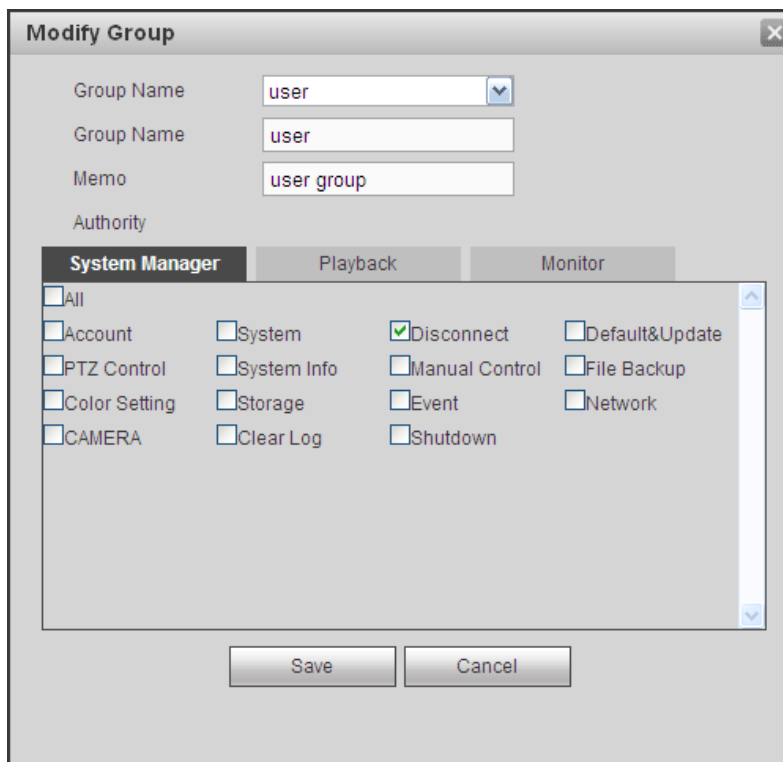

Figure 5-87

5.8.5.8 Auto maintain

The auto maintain interface is shown as in Figure 5-88.

Here you can select auto reboot and auto delete old files interval from the dropdown list.

If you want to use the auto delete old files function, you need to set the file period.

Click Manual reboot button, you can restart device manually.

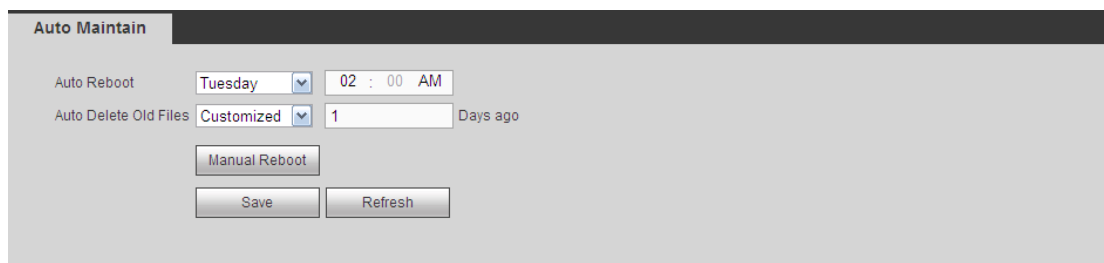

Figure 5-88

5.8.5.9 Import/Export

The interface is shown as in Figure 5-89.



Figure 5-89

Please refer to the following sheet for detailed information.

Parameter	Function
Import	It is to import the local setup files to the system.
Export	It is to export the corresponding WEB setup to your local PC.

5.8.5.10 Default

The default setup interface is shown as in Figure 5-90.

Here you can select Channel/Network/Event/Storage/System. Or you can check the All box to select all items.

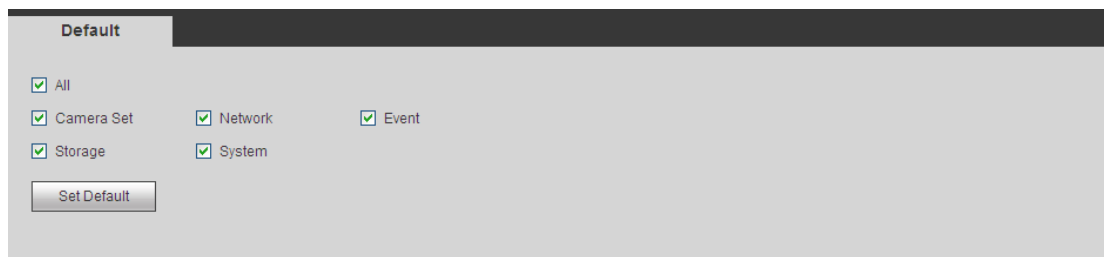

Figure 5-90

5.8.5.11 Upgrade

The upgrade interface is shown as in Figure 5-91.

Please select the upgrade file and then click the update button to begin update. Please note the file name shall be as *.bin. During the upgrade process, do not unplug the power cable, network cable, or shutdown the device.

Important

Improper upgrade program may result in device malfunction!

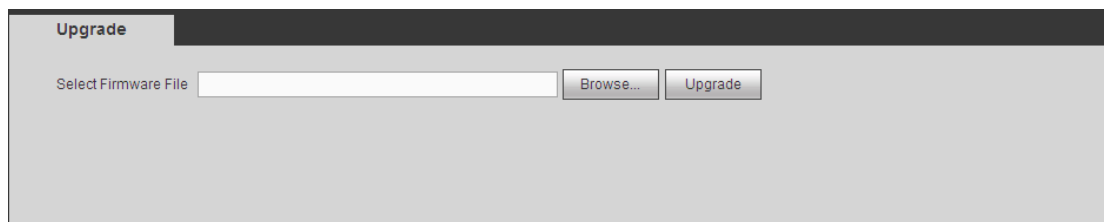

Figure 5-91

5.9 Information

5.9.1 Version

The version interface is shown as in Figure 5-92.

Here you can view record channel, alarm input/output information, software version, release date and etc. Please note the following information is for reference only.



Figure 5-92

5.9.2 Log

Here you can view system log. See Figure 5-93.

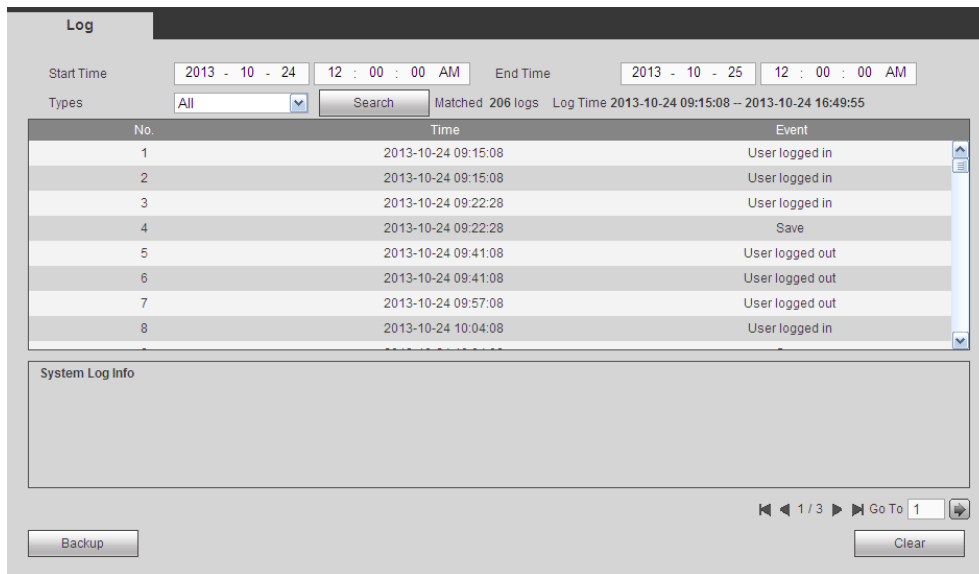

Figure 5-93

Please refer to the following sheet for log parameter information.

Parameter	Function
Type	Log types include: system operation, configuration operation, data operation, event operation, record operation, user management, log clear.
Start time	Set the start time of the requested log.
End time	Set the end time of the requested log.
Search	You can select log type from the drop down list and then click search button to view the list. You can click the stop button to terminate current search operation.
Detailed information	You can select one item to view the detailed information.
Clear	You can click this button to delete all displayed log files. Please note system does not support clear by type.
Backup	You can click this button to backup log files to current PC.

5.9.3 Connection Log

Please set start time, end time, channel number and then click Search button, you can view the corresponding connection log of current channel. See Figure 5-94.

Connect Log

Start Time: 2013 - 10 - 24 12 : 00 : 00 AM End Time: 2013 - 10 - 25 12 : 00 : 00 AM

Channel: All

	Channel	Time	IP	Connect
1	22	2013-10-24 16:21:05	10.15.6.169	User logged in
2	21	2013-10-24 16:21:05	10.15.6.169	User logged in
3	19	2013-10-24 16:21:03	10.15.6.218	User logged in
4	22	2013-10-24 16:16:09	10.15.6.169	User logged in
5	21	2013-10-24 16:16:03	10.15.6.169	User logged in
6	19	2013-10-24 15:12:27	10.15.6.218	User logged in
7	19	2013-10-24 15:12:05	10.15.6.218	Offline
8	20	2013-10-24 15:11:17	10.15.6.223	Offline

Figure 5-94

5.9.4 Online User

The online user interface is shown as in Figure 5-95.

Online User

No.	User Name	Group Name	IP Address	User Login Time
1	admin	admin	10.15.9.152	2013-10-24 04:31:33 PM
2	admin	admin	10.15.9.152	2013-10-24 04:21:12 PM
3	admin	admin	10.15.6.145	2013-10-24 04:50:01 PM

Figure 5-95

5.10 Playback

Click Playback button, you can see an interface is shown as in Figure 5-96.

Please set record type, record date, window display mode and channel name.

You can click the date on the right pane to select the date. The green highlighted date is system current date and the blue highlighted date means it has record files.

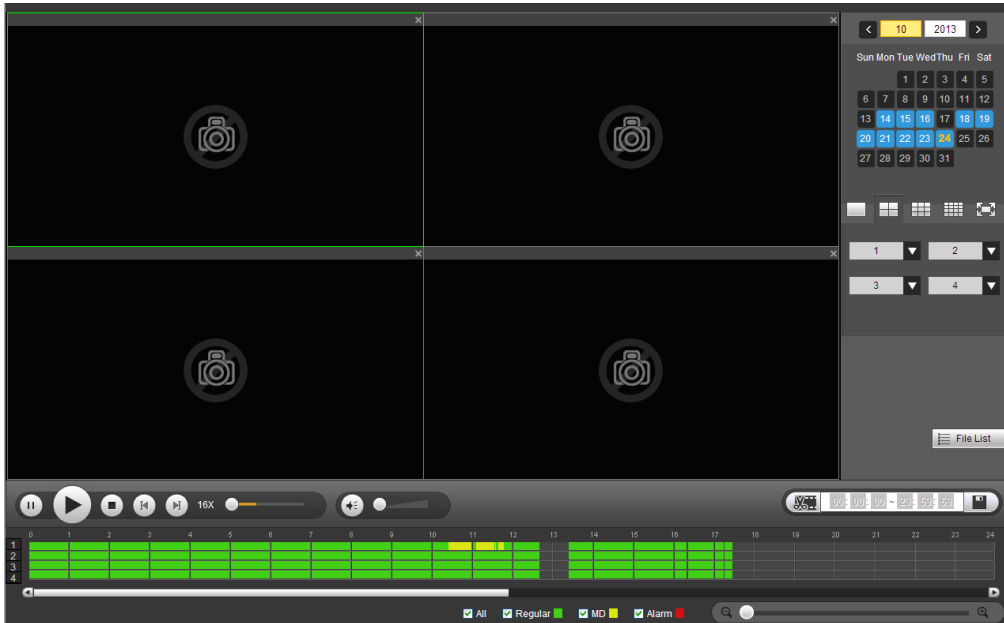

Figure 5-96

Then please click File list button, you can see the corresponding files in the list. See Figure 5-97.

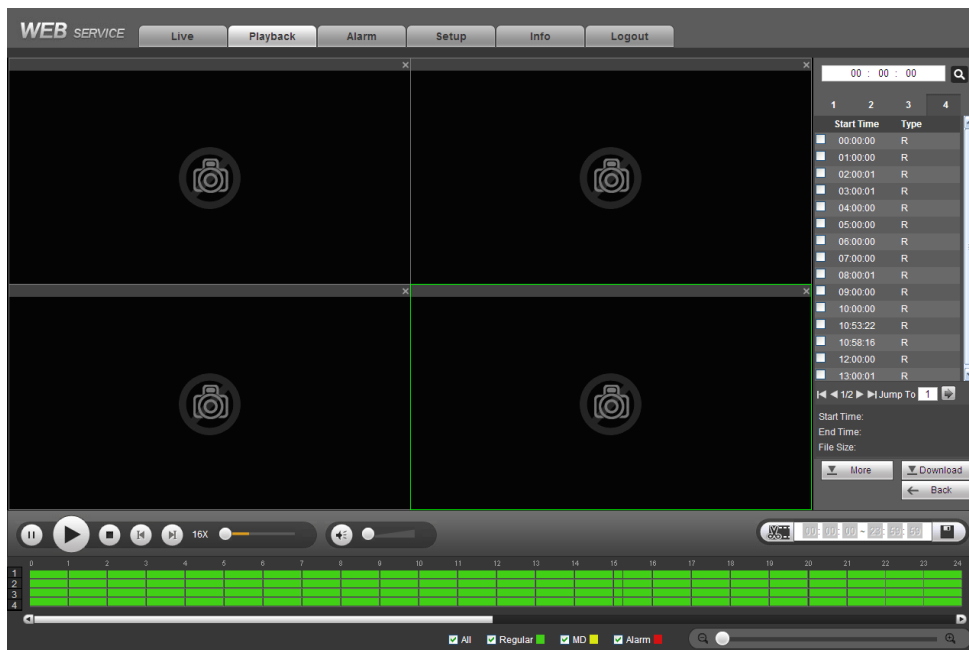

Figure 5-97

Select a file you want to play and then click Play button, system can begin playback. You can select to playback in full-screen. Please note for one channel, system can not playback and download at the same time. You can use the playback control bar to implement various operations such as play, pause, stop, slow play, fast play and etc. See Figure 5-98.

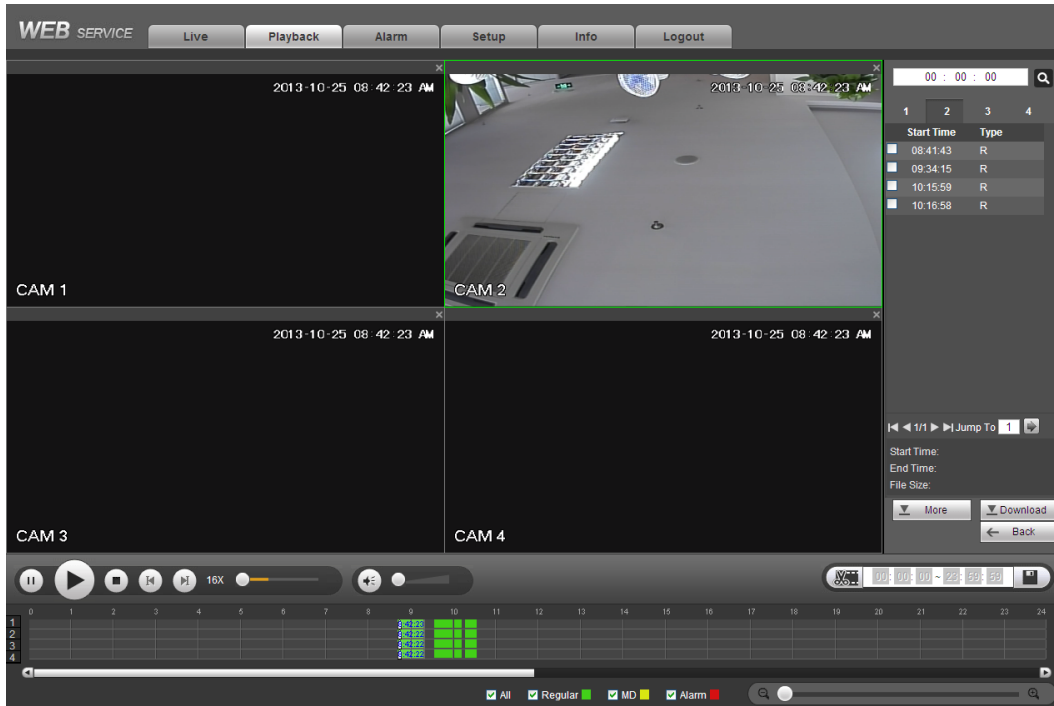

Figure 5-98

Select the file(s) you want to download and then click download button, you can see an interface shown as in Figure 5-99. The Download button becomes Stop button and there is a process bar for your reference. Please go to you default file saved path to view the files.

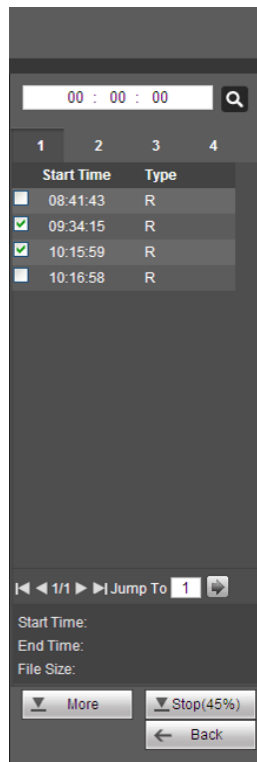

Figure 5-99

Load more

It is for you to search record or picture. You can select record channel, record type and record time to download. There are two download types. The download by file interface is shown as in Figure 5-100 and the download by time interface is shown as in Figure 5-101.

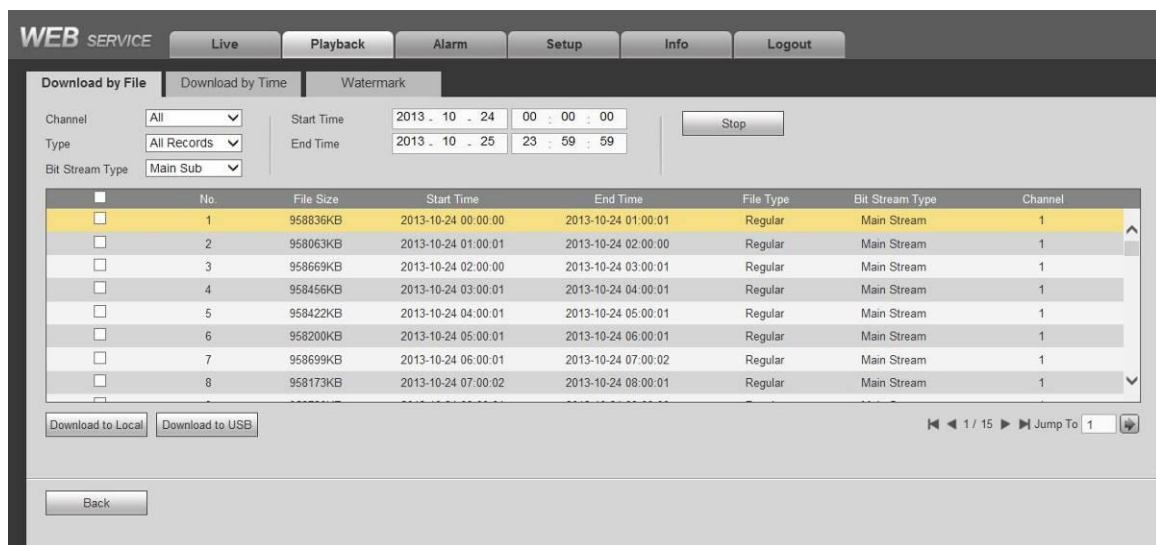

Figure 5-100

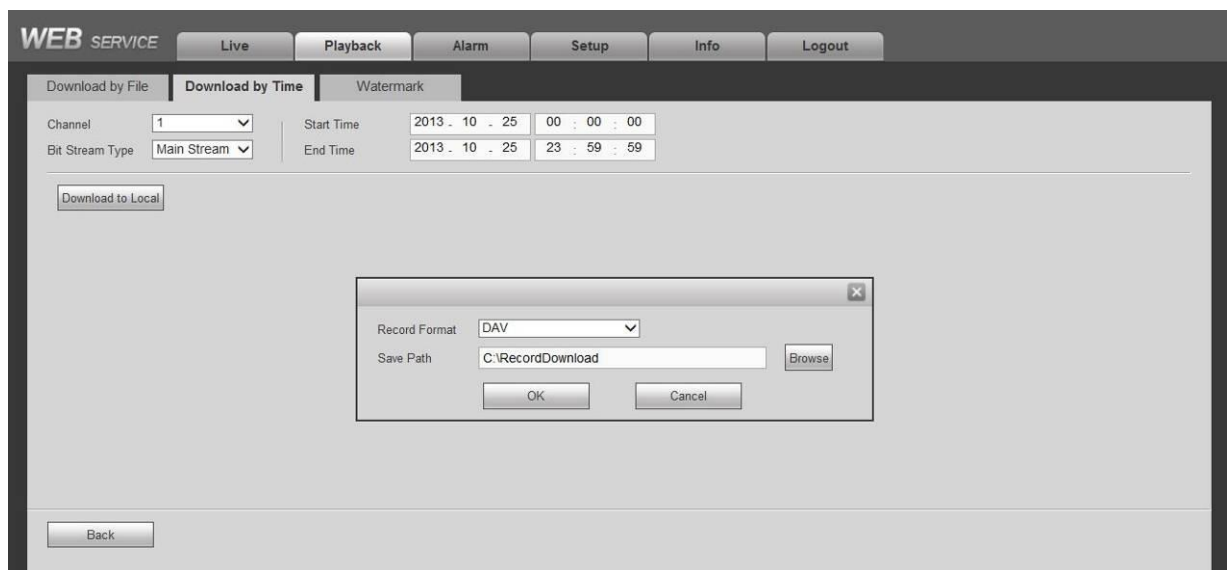

Figure 5-101

Watermark

Watermark interface is shown as In Figure 5-100. Please select a file and then click Verify button to see the file has been tampered with or not

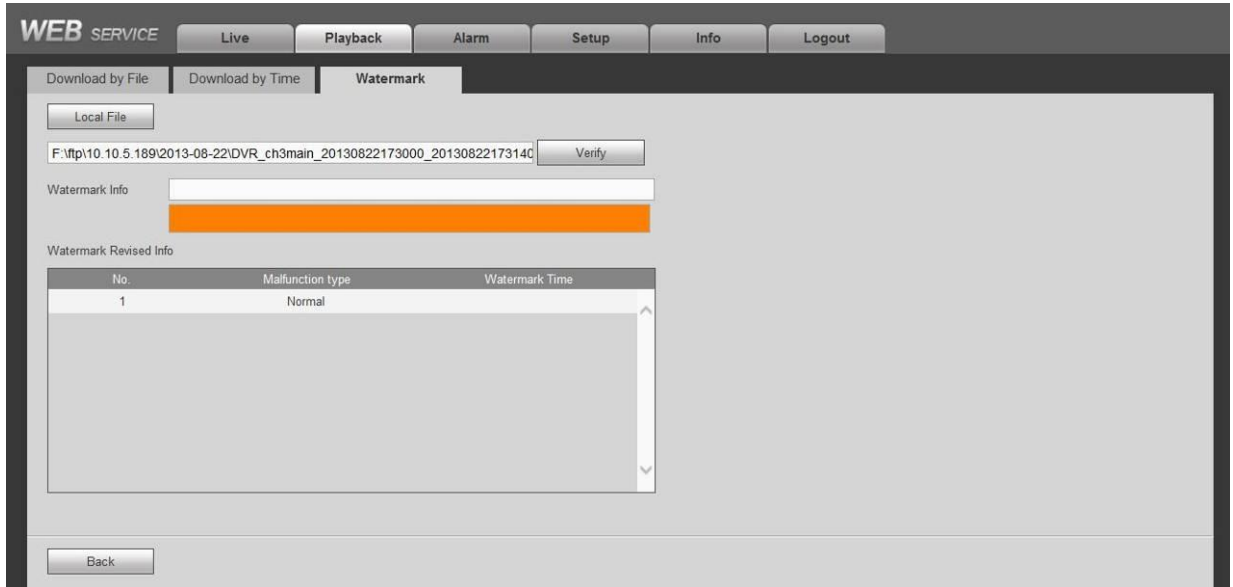

Figure 5-102

5.11 Alarm

Click alarm function, you can see an interface is shown as Figure 5-103.

Here you can set device alarm type and alarm sound setup (Please make sure you have enabled audio function of corresponding alarm events.).

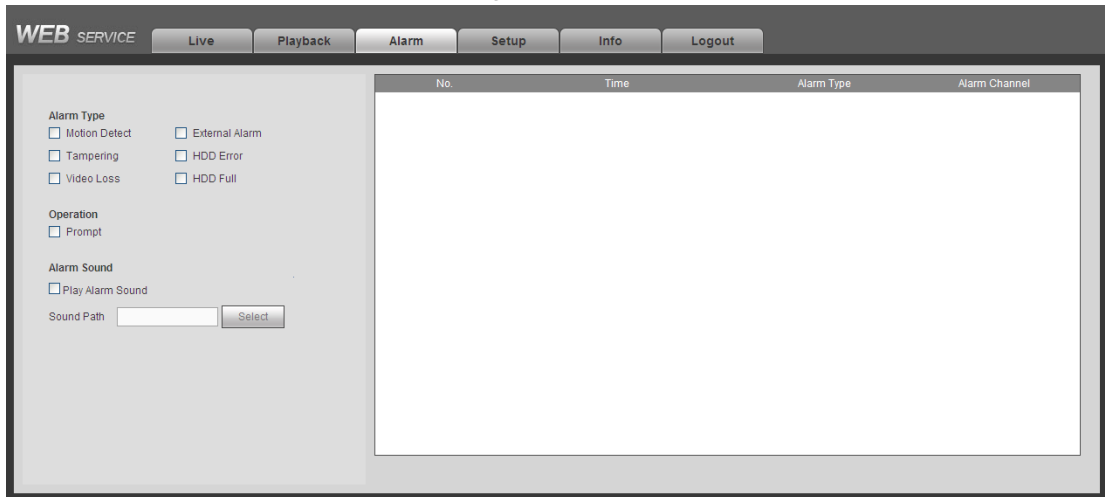

Figure 5-103

Please refer to the following sheet for detailed information.

Type	Parameter	Function
Alarm Type	Video loss	System alarms when video loss occurs.
	Motion detection	System alarms when motion detection alarm occurs.
	Tampering	System alarms when camera is viciously masking.
	Disk full	System alarms when disk is full.

Type	Parameter	Function
	Disk error	System alarms when disk error occurs.
	External alarm	Alarm input device sends out alarm.
Operation	Prompt	Check the box here, system can automatically pops up an alarm icon on the Alarm button in the main interface when there is an alarm.
Alarm Sound	Play alarm sound	System sends out alarm sound when an alarm occurs. You can specify as you wish.
	Sound path	Here you can specify alarm sound file.

5.12 Log out

Click log out button, system goes back to log in interface. See Figure 5-104. You need to input user name and password to login again.

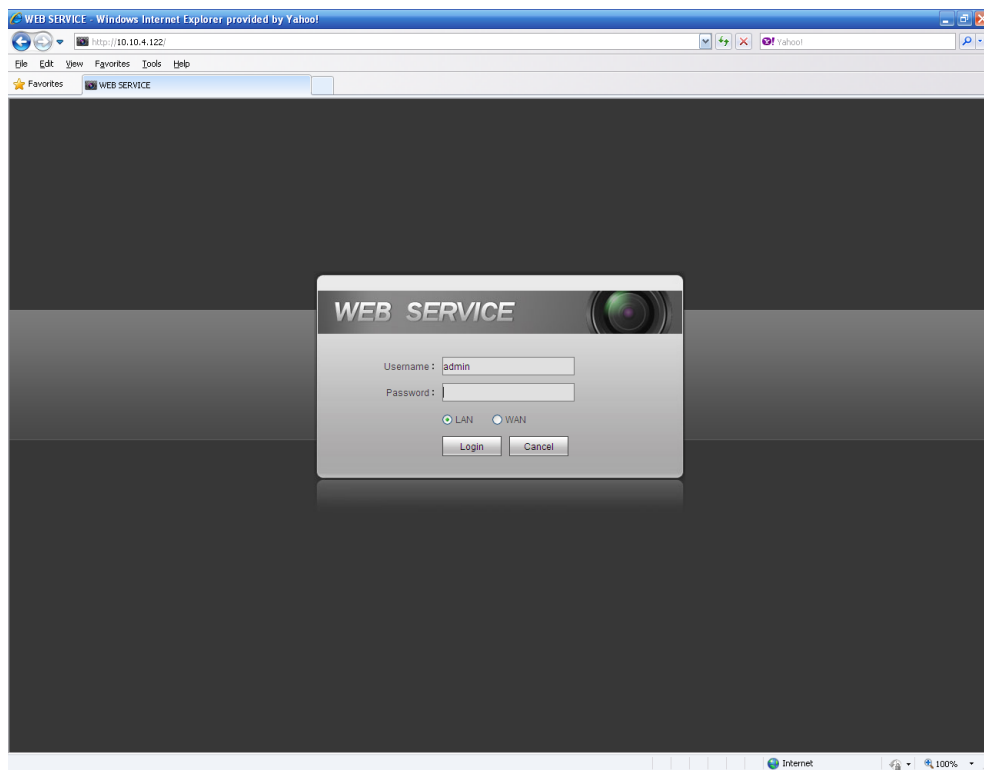

Figure 5-104

5.13 Un-install Web Control

You can use web un-install tool “uninstall web.bat” to un-install web control.

Please note, before you un-installation, please close all web pages, otherwise the un-installation might result in error.

6 Professional Surveillance System

Besides Web, you can use our Professional Surveillance Software (PSS) to login the device.

For detailed information, please refer to *PSS user's manual*.

7 FAQ

1. DVR can not boot up properly.

There are following possibilities:

- Input power is not correct.
- Power connection is not correct.
- Power switch button is damaged.
- Program upgrade is wrong.
- HDD malfunction or something wrong with HDD ribbon.
- Seagate DB35.1, DB35.2, SV35 or Maxtor 17-g has compatibility problem.
Please upgrade to the latest version to solve this problem.
- Front panel error.
- Main board is damaged.

2. DVR often automatically shuts down or stops running.

There are following possibilities:

- Input voltage is not stable or it is too low.
- HDD malfunction or something wrong with the ribbon.
- Button power is not enough.
- Front video signal is not stable.
- Working environment is too harsh, too much dust.
- Hardware malfunction.

3. System can not detect hard disk.

There are following possibilities:

- HDD is broken.
- HDD ribbon is damaged.
- HDD cable connection is loose.
- Main board SATA port is broken.

4. There is no video output whether it is one-channel, multiple-channel or all-channel output.

There are following possibilities:

- Program is not compatible. Please upgrade to the latest version.
- Brightness is 0. Please restore factory default setup.
- There is no video input signal or it is too weak.
- Check privacy mask setup or your screen saver.
- DVR hardware malfunctions.

5. Real-time video color is distorted.

There are following possibilities:

- When using BNC output, NTSC and PAL setup is not correct. The real-time video becomes black and white.

- DVR and monitor resistance is not compatible.
- Video transmission is too long or degrading is too huge.
- DVR color or brightness setup is not correct.

6. Can not search local records.

There are following possibilities:

- HDD ribbon is damaged.
- HDD is broken.
- Upgraded program is not compatible.
- The recorded file has been overwritten.
- Record function has been disabled.

7. Video is distorted when searching local records.

There are following possibilities:

- Video quality setup is too low.
- Program read error, bit data is too small. There is mosaic in the full screen. Please restart the DVR to solve this problem.
- HDD data ribbon error.
- HDD malfunction.
- DVR hardware malfunctions.

8. There is no audio when monitor.

There are following possibilities:

- It is not a power picker.
- It is not a power acoustics.
- Audio cable is damaged.
- DVR hardware malfunctions.

9. There is audio when monitor but there is no audio when system playback.

There are following possibilities:

- Setup is not correct. Please enable audio function
- Corresponding channel has no video input. Playback is not continuous when the screen is blue.

10. Time display is not correct.

There are following possibilities:

- Setup is not correct
- Battery contact is not correct or voltage is too low.
- Crystal is broken.

11. DVR can not control PTZ.

There are following possibilities:

- Front panel PTZ error

- PTZ decoder setup, connection or installation is not correct.
- Cable connection is not correct.
- PTZ setup is not correct.
- PTZ decoder and DVR protocol is not compatible.
- PTZ decoder and DVR address is not compatible.
- When there are several decoders, please add 120 Ohm between the PTZ decoder A/B cables furthest end to delete the reverberation or impedance matching. Otherwise the PTZ control is not stable.
- The distance is too far.

12. Motion detection function does not work.

There are following possibilities:

- Period setup is not correct.
- Motion detection zone setup is not correct.
- Sensitivity is too low.
- For some versions, there is hardware limit.

13. Can not log in client-end or web.

There are following possibilities:

- For Windows 98 or Windows ME user, please update your system to Windows 2000 sp4. Or you can install client-end software of lower version. Please note right now, our DVR is not compatible with Windows VISTA control.
- ActiveX control has been disabled.
- No dx8.1 or higher. Please upgrade display card driver.
- Network connection error.
- Network setup error.
- Password or user name is invalid.
- Client-end is not compatible with DVR program.

14. There is only mosaic no video when preview or playback video file remotely.

There are following possibilities:

- Network fluency is not good.
- Client-end resources are limit.
- There is multiple-cast group setup in DVR. This mode can result in mosaic. Usually we do not recommend this mode.
- There is privacy mask or channel protection setup.
- Current user has no right to monitor.
- DVR local video output quality is not good.

15. Network connection is not stable.

There are following possibilities:

- Network is not stable.
- IP address conflict.

- MAC address conflict.
- PC or DVR network card is not good.

16. Burn error /USB back error.

There are following possibilities:

- Burner and DVR are in the same data cable.
- System uses too much CPU resources. Please stop record first and then begin backup.
- Data amount exceeds backup device capacity. It may result in burner error.
- Backup device is not compatible.
- Backup device is damaged.

17. Keyboard can not control DVR.

There are following possibilities:

- DVR serial port setup is not correct
- Address is not correct
- When there are several switchers, power supply is not enough.
- Transmission distance is too far.

18. Alarm signal can not be disarmed.

There are following possibilities:

- Alarm setup is not correct.
- Alarm output has been open manually.
- Input device error or connection is not correct.
- Some program versions may have this problem. Please upgrade your system.

19. Alarm function is null.

There are following possibilities:

- Alarm setup is not correct.
- Alarm cable connection is not correct.
- Alarm input signal is not correct.
- There are two loops connect to one alarm device.

20. Remote control does not work.

There are following possibilities:

- Remote control address is not correct.
- Distance is too far or control angle is too small.
- Remote control battery power is low.
- Remote control is damaged or DVR front panel is damaged.

21. Record storage period is not enough.

There are following possibilities:

- Camera quality is too low. Lens is dirty. Camera is installed against the light. Camera aperture setup is not correct.
- HDD capacity is not enough.
- HDD is damaged.

22. Can not playback the downloaded file.

There are following possibilities:

- There is no media player.
- No DXB8.1 or higher graphic acceleration software.
- There is no DivX503Bundle.exe control when you play the file transformed to AVI via media player.
- No DivX503Bundle.exe or ffdshow-2004 1012 .exe in Windows XP OS.

23. Forgot local menu operation password or network password

Please contact your local service engineer or our sales person for help. We can guide you to solve this problem.

24. When I login via HTTPS, a dialogue says the certificate for this website is for other address.

Please follow chapter 5.8.2.15.1 to create server certificate.

25. When I login via HTTPS, a dialogue says the certificate is not trusted.

Please follow chapter 5.8.2.15.2 to download root certificate.

26. When I login via HTTPS, a dialogue says the certificate has expired or is not valid yet.

Please make sure your PC time is the same as the device time.

Daily Maintenance

- Please use the brush to clean the board, socket connector and the chassis regularly.
- The device shall be soundly earthed in case there is audio/video disturbance. Keep the device away from the static voltage or induced voltage.
- Please unplug the power cable before you remove the audio/video signal cable, RS232 or RS485 cable.
- Do not connect the TV to the local video output port (VOUT).It may result in video output circuit.
- Always shut down the device properly. Please use the shutdown function in the menu, or you can press the power button in the front pane for at least three seconds to shut down the device. Otherwise it may result in HDD malfunction.
- Please make sure the device is away from the direct sunlight or other heating sources. Please keep the sound ventilation.

- Please check and maintain the device regularly.

Appendix A HDD Capacity Calculation

Calculate total capacity needed by each DVR according to video recording (video recording type and video file storage time).

Step 1: According to Formula (1) to calculate storage capacity q_i that is the capacity of each channel needed for each hour, unit Mbyte.

$$q_i = d_i \div 8 \times 3600 \div 1024 \quad (1)$$

In the formula: d_i means the bit rate, unit Kbit/s

Step 2: After video time requirement is confirmed, according to Formula (2) to calculate the storage capacity m_i , which is storage of each channel needed unit Mbyte.

$$m_i = q_i \times h_i \times D_i \quad (2)$$

In the formula:

h_i means the recording time for each day (hour)

D_i means number of days for which the video shall be

kept

Step 3: According to Formula (3) to calculate total capacity (accumulation) q_T that is needed for all channels in the DVR during **scheduled video recording**.

$$q_T = \sum_{i=1}^c m_i \quad (3)$$

In the formula: c means total number of channels in one DVR

Step 4: According to Formula (4) to calculate total capacity (accumulation) q_T that is needed for all channels in DVR during **alarm video recording (including motion detection)**.

$$q_T = \sum_{i=1}^c m_i \times a\% \quad (4)$$

In the formula: $a\%$ means alarm occurrence rate

You can refer to the following sheet for the file size in one hour per channel. (All the data listed below are for reference only.)

Bit stream size (max)	File size	Bit stream size (max)	File size
96K	42M	128K	56M
160K	70M	192K	84M
224K	98M	256K	112M
320K	140M	384K	168M

448K	196M	512K	225M
640K	281M	768K	337M
896K	393M	1024K	450M
1280K	562M	1536K	675M
1792K	787M	2048K	900M

Appendix B Compatible backup devices

Appendix B-1 Compatible USB list

Manu factor	Model	Capacity
Sandisk	Cruzer Micro	512M
Sandisk	Cruzer Micro	1G
Sandisk	Cruzer Micro	2G
Sandisk	Cruzer Freedom	256M
Sandisk	Cruzer Freedom	512M
Sandisk	Cruzer Freedom	1G
Sandisk	Cruzer Freedom	2G
Kingston	DataTraveler II	1G
Kingston	DataTraveler II	2G
Kingston	DataTraveler	1G
Kingston	DataTraveler	2G
Maxell	USB Flash Stick	128M
Maxell	USB Flash Stick	256M
Maxell	USB Flash Stick	512M
Maxell	USB Flash Stick	1G
Maxell	USB Flash Stick	2G
Kingax	Super Stick	128M
Kingax	Super Stick	256M
Kingax	Super Stick	512M
Kingax	Super Stick	1G
Kingax	Super Stick	2G
Netac	U210	128M
Netac	U210	256M
Netac	U210	512M
Netac	U210	1G
Netac	U210	2G
Netac	U208	4G
Teclast	Ti Cool	128M
Teclast	Ti Cool	256M
Teclast	Ti Cool	512M
Teclast	Ti Cool	1G
SanDisk	cruzer mirco	2G
SanDisk	cruzer mirco	8G
SanDisk	Ti Cool	2G
SanDisk	Hongjiao	4G
Lexar	Lexar	256MB
Kingston	Data Traveler	1G
Kingston	Data Traveler	16GB

Kingston	Data Traveler	32GB
Aigo	L8315	16GB
Sandisk	250	16GB
Kingston	Data Traveler Locker+	32GB
Netac	U228	8GB

Appendix B-2 Compatible SD Card list

Brand	Standard	Capacity	Card type
Transcend	SDHC6	16GB	Big
Kingston	SDHC4	4GB	Big
Kingston	SD	2GB	Big
Kingston	SD	1GB	Big
Sandisk	SDHC2	8GB	Small
Sandisk	SD	1GB	Small

Appendix B-3 Compatible Portable HDD list

Brand	Model	Capacity
YDStar	YDstar HDD box	40G
Netac	Netac	80G
lomega	lomega RPHD-CG" RNAJ50U287	250GB
WD Elements	WCAVY1205901	1.5TB
Newsmy	Liangjian	320GB
WD Elements	WDBAAR5000ABK-00	500GB
WD Elements	WDBAAU0015HBK-00	1.5TB
Seagate	FreeAgent Go(ST905003F)	500GB
Aigo	H8169	500GB

Appendix B-4 Compatible USB DVD List

Brand	Model
Samsung	SE-S084
BenQ	LD2000-2K4

Appendix B-5 Compatible SATA DVD List

Brand	Model
LG	GH22NS30
Samsung	TS-H653 Ver.A

Samsung	TS-H653 Ver.F
Samsung	SH-224BB/CHXH
SONY	DRU-V200S
SONY	DRU-845S
SONY	AW-G170S
Pioneer	DVR-217CH

Appendix B-6 Compatible SATA HDD List

NOTE: Please upgrade the DVR firmware to latest version to ensure the accuracy of the table below. Here we recommend HDD of 500G to 4T capacity.

Manufacturer	Series	Model	Capacity	Port Mode
Seagate	Seagate SV35.1	ST3250824SV	250G	SATA
Seagate	Seagate SV35.1	ST3500641SV	500G	SATA
Seagate	Seagate SV35.2	ST3250820SV	250G	SATA
Seagate	Seagate SV35.2	ST3320620SV	320G	SATA
Seagate	Seagate SV35.2	ST3500630SV	500G	SATA
Seagate	Seagate SV35.2	ST3750640SV	750G	SATA
Seagate	Seagate SV35.3	ST3250310SV	250G	SATA
Seagate	Seagate SV35.3	ST3500320SV	500G	SATA
Seagate	Seagate SV35.3	ST3750330SV	750G	SATA
Seagate	Seagate SV35.3	ST31000340SV	1T	SATA
Seagate	Seagate SV35.4	ST3320410SV	320G	SATA
Seagate	Seagate SV35.4	ST3250311SV	250G	SATA
Seagate	Seagate SV35.5	ST3500410SV	500G	SATA
Seagate	Seagate SV35.5	ST3500411SV	500G	SATA
Seagate	Seagate SV35.5	ST31000525SV	1T	SATA
Seagate	Seagate SV35.5	ST31000526SV	1T	SATA
Seagate	Seagate SV35.5	ST1000VX000	1T	SATA
Seagate	Seagate SV35.5	ST2000VX003	2T	SATA
Seagate	Seagate SV35.5	ST2000VX002	2T	SATA
Seagate	Seagate SV35.5	ST2000VX000	2T	SATA
Seagate	Seagate SV35.5	ST3000VX000	3T	SATA
Seagate	Seagate Pipeline HD	ST3320410CS	320G	SATA
Seagate	Seagate Pipeline HD	ST3320310CS	320G	SATA
Seagate	Seagate Pipeline HD	ST3500422CS	500G	SATA
Seagate	Seagate Pipeline HD	ST3500321CS	500G	SATA
Seagate	Seagate Pipeline HD2	ST3250412CS	250G	SATA
Seagate	Seagate Pipeline HD2	ST3320311CS	250G	SATA
Seagate	Seagate Pipeline HD2	ST3500414CS	500G	SATA
Seagate	Seagate Pipeline HD2	ST3500312CS	500G	SATA
Seagate	Seagate Pipeline HD2	ST31000424CS	1T	SATA

Seagate	Seagate Pipeline HD2	ST31000322CS	1T	SATA
Seagate	Seagate Pipeline HD2	ST1000VM002	1T	SATA
Seagate	Seagate Pipeline HD2	ST1500VM002	1T	SATA
Seagate	Seagate Pipeline HD2	ST2000VM002	2T	SATA
Seagate	Seagate Pipeline HD2	ST2000VM003	2T	SATA
Seagate	Seagate Constellation ES	ST3500514NS	500G	SATA
Seagate	Seagate Constellation ES	ST31000524NS	1T	SATA
Seagate	Seagate Constellation ES	ST32000644NS	2T	SATA
Seagate	Seagate Constellation ES	ST2000NM0011	2T	SATA
Seagate	Seagate Constellation ES	ST1000NM0011	1T	SATA
Seagate	Seagate Constellation ES	ST500NM0011	500G	SATA
Seagate	Seagate Constellation ES	ST2000NM0031	2T	SATA
Seagate	Seagate Constellation ES	ST1000NM0031	1T	SATA
Seagate	Seagate Constellation ES	ST500NM0031	500G	SATA
Seagate	Seagate Constellation ES	ST2000NM0051	2T	SATA
Seagate	Seagate Constellation ES	ST1000NM0051	1T	SATA
Seagate	Seagate Constellation ES	ST500NM0051	500G	SATA
Seagate	Seagate Constellation ES.2	ST33000650NS	3T	SATA
Seagate	Seagate Constellation ES.2	ST32000645NS	2T	SATA
Seagate	Seagate Constellation ES.2	ST33000651NS	3T	SATA
Seagate	Seagate Constellation ES.2	ST32000646NS	2T	SATA
Seagate	Seagate Constellation ES.2	ST33000652NS	3T	SATA
Seagate	Seagate Constellation ES.2	ST32000647NS	2T	SATA
Western Digital	Cariar SE	WD3200JD	320G	SATA
Western Digital	Cariar SE	WD3000JD	300G	SATA

Western Digital	Caviar SE	WD2500JS	250G	SATA
Western Digital	Caviar SE16	WD7500KS	750G	SATA
Western Digital	Caviar SE16	WD5000KS	500G	SATA
Western Digital	Caviar SE16	WD4000KD	400G	SATA
Western Digital	Caviar SE16	WD3200KS	320G	SATA
Western Digital	Caviar SE16	WD2500KS	250G	SATA
Western Digital	WD Caviar SE16	WD2500YS-01SHB0	250G	SATA
Western Digital	WD Caviar RE16	WD3200YS-01PGB0	320G	SATA
Western Digital	WD Caviar RE2	WD5000YS-01MPB0	500G	SATA
Western Digital	WD AV—AVJS	WD2500AVJS-63WDA0	500G	SATA
Western Digital	WD AV—AVJS	WD3200AVJS-63WDA0	320G	SATA
Western Digital	WD AV—AVJS	WD5000AVJS-63YJA0	500G	SATA
Western Digital	WDAV-GP—AVCS	WD5000AVCS-63H1B1	500G	SATA
Western Digital	WDAV-GP—AVCS	WD7500AVCS-63ZLB0	750G	SATA
Western Digital	WDAV-GP—AVCS	WD3200AVCS	320G	SATA
Western Digital	WDAV-GP—AVCS	WD2500AVCS	250G	SATA
Western Digital	WDAV-GP—EVCS	WD10EVCS-63ZLB0	1T	SATA
Western Digital	WDAV-GP—EVCS	WD20EVCS-63ZLB0	2T	SATA
Western Digital	WDAV-GP—AVVS	WD3200AVVS-63L2B0	320G	SATA
Western Digital	WDAV-GP—AVVS	WD5000AVVS-63ZWB0	500G	SATA
Western Digital	WDAV-GP—AVVS	WD7500AVVS-63E1B1	750G	SATA
Western Digital	WDAV-GP—AVVS	WD7500AVVS-63E1B1	750G	SATA
Western Digital	WDAV-GP—EVVS	WD10EVVS-63E1B1	1T	SATA
Western Digital	WDAV-GP—EVDS	WD10EVDS-63N5B1	1T	SATA
Western Digital	WDAV-GP—EVDS	WD15EVDS-63V9B0	1.5T	SATA
Western Digital	WDAV-GP—EVDS	WD20EVDS-63T3B0	2T	SATA
Western Digital	WDAV-GP—AVDS	WD5000AVDS-63U7B0	500G	SATA
Western Digital	WD AV-GP	WD30EURS	3T	SATA
Western Digital	WD AV-GP	WD25EURS	2.5T	SATA
Western Digital	WD AV-GP	WD20EURS	2T	SATA
Western Digital	WD AV-GP	WD15EURS	1.5T	SATA
Western Digital	WD AV-GP	WD10EURS	1T	SATA
Western Digital	WD AV-GP	WD10EURX	1T	SATA
Western Digital	WD AV-GP	WD7500AURS	750G	SATA
Western Digital	WD AV-GP	WD7500AVDS	500G	SATA
Western Digital	WD AV-GP	WD500AVDS	500G	SATA
Western Digital	WD AV-GP	WD10EUCX	1T	SATA
Samsung	Samsung—HA	HA500LJ/CE	500G	SATA
Samsung	Samsung—HA	HA751LJ	750G	SATA
Samsung	Samsung—HA	HA101UJ/CE	1T	SATA
Samsung	Samsung—HD	HD502HI/CEC	500G	SATA
Samsung	Samsung—HD	HD103SI/CEC	1T	SATA
Samsung	Samsung—HD	HD154UI/CE	1.5T	SATA

Hitachi	HitachiCinemaStar™ 5K500	HCP725050GLA380	500G	SATA
Hitachi	HitachiCinemaStar™ 7K1000.B	HCT721050SLA360	500G	SATA
Hitachi	HitachiCinemaStar™ 7K1000.B	HCT721075SLA360	750G	SATA
Hitachi	HitachiCinemaStar™ 7K1000.B	HCT721010SLA360	1T	SATA
Maxtor	DiamondMax 20	STM3320820AS	320G	SATA
Maxtor	DiamondMax 20	STM3250820AS	250G	SATA

Appendix C Compatible CD/DVD Burner List

NOTE: Please upgrade the DVR firmware to latest version to ensure the accuracy of the table below. And you can use the USB cable with the model recommended to set USB burner.

Manufacturer	Model	Port Type	Type
Sony	DRX-S50U	USB	DVD-RW
Sony	DRX-S70U	USB	DVD-RW
Sony	AW-G170S	SATA	DVD-RW
Samsung	TS-H653A	SATA	DVD-RW
Panasonic	SW-9588-C	SATA	DVD-RW
Sony	DRX-S50U	USB	DVD-RW
BenQ	5232WI	USB	DVD-RW

Appendix D Compatible Displayer List

Please refer to the following sheet form compatible displayer list.

Brand	Model	Dimension (Unit: inch)
BENQ (LCD)	ET-0007-TA	19-inch (wide screen)
DELL (LCD)	E178FPc	17-inch
BENQ (LCD)	Q7T4	17-inch
BENQ (LCD)	Q7T3	17-inch
HFNOVO (LCD)	LXB-L17C	17-inch
SANGSUNG (LCD)	225BW	22 寸(wide screen)
HFNOVO(CRT)	LXB-FD17069HB	17 -inch
HFNOVO(CRT)	LXB-HF769A	17-inch
HFNOVO(CRT)	LX-GJ556D	17-inch
Samsung (LCD)	2494HS	24-inch
Samsung (LCD)	P2350	23-inch
Samsung (LCD)	P2250	22-inch
Samsung (LCD)	P2370G	23-inch
Samsung (LCD)	2043	20-inch
Samsung (LCD)	2243EW	22-inch
Samsung (LCD)	SMT-1922P	19-inch
Samsung (LCD)	T190	19-inch
Samsung (LCD)	T240	24-inch
LG (LCD)	W1942SP	19-inch
LG (LCD)	W2243S	22-inch
LG (LCD)	W2343T	23-inch
BENQ (LCD)	G900HD	18.5-inch
BENQ(LCD)	G2220HD	22-inch
PHILIPS (LCD)	230E	23-inch
PHILIPS (LCD)	220CW9	23-inch
PHILIPS (LCD)	220BW9	24-inch
PHILIPS (LCD)	220EW9	25-inch

Appendix E Compatible Switcher

Brand	Model	network working mode
D-LinK	DES-1016D	10/100M self-adaptive
D-LinK	DES-1008D	10/100M self-adaptive
Ruijie	RG-S1926S	Five network modes 1. AUTO 2. HALF-10M 3. FULL-10M 4. HALF-100M 5. FULL-100M
H3C	H3C-S1024	10/100M self-adaptive
TP-LINK	TL-SF1016	10/100M self-adaptive
TP-LINK	TL-SF1008+	10/100M self-adaptive

Appendix F Compatible Wireless Mouse List

Please refer to the following sheet for compatible SD card brand.

Brand	Model
SUNT 讯拓™	V80
Rapoo	3500
Logitech	M215
Shuangfeiyan	Tianyao G7-630

Appendix G Earthing

1. What is the surge?

Surge is a short current or voltage change during a very short time. In the circuit, it lasts for microsecond. In a 220V circuit, the 5KV or 10KV voltage change during a very short time (about microseconds) can be called a surge. The surge comes from two ways: external surge and internal surge.

- The external surge: The external surge mainly comes from the thunder lightning. Or it comes from the voltage change during the on/off operation in the electric power cable.
- The internal surge: The research finds 88% of the surge from the low voltage comes from the internal of the building such as the air conditioning, elevator, electric welding, air compressor, water pump, power button, duplicating machine and other device of inductive load.

The lightning surge is far above the load level the PC or the micro devices can support. In most cases, the surge can result in electric device chip damage, PC error code, accelerating the part aging, data loss and etc. Even when a small 20 horsepower inductive engine boots up or stops, the surge can reach 3000V to 50000V, which can adversely affect the electronic devices that use the same distribution box.

To protect the device, you need to evaluate its environment, the lightning affection degree objectively. Because surge has close relationship with the voltage amplitude, frequency, network structure, device voltage-resistance, protection level, ground and etc. The thunder proof work shall be a systematic project, emphasizing the all-round protection (including building, transmission cable, device, ground and etc.). There shall be comprehensive management and the measures shall be scientific, reliable, practical and economic. Considering the high voltage during the inductive thundering, the International Electrotechnical Committee (IEC) standard on the energy absorbing step by step theory and magnitude classification in the protection zone, you need to prepare multiple precaution levels.

You can use the lightning rod, lightning strap or the lightning net to reduce the damage to the building, personal injury or the property,

- The lightning protection device can be divided into three types:
Power lightning arrester: There are 220V single-phrase lightning arrester and 380V three-phrase lightening arrester (mainly in parallel connection, sometimes use series connection) You can parallel connect the power lightning arrester in the electric cable to reduce the short-time voltage change and release the surge current. From the BUS to the device, there are usually three levels so that system can reduce the voltage and release the current step by step to remove the thunderstorm energy and guarantee the device safety. You can select the replaceable module type, the terminal connection type and portable socket according to your requirement.

- Signal lightning arrester: This device is mainly used in the PC network, communication system. The connection type is serial connection. Once you connected the signal lightning arrester with the signal port, it can cut the channel of the thunderstorm to the device, and on the other hand, it can discharge the current to the ground to guarantee the device proper work. The signal lightning arrester has many specifications, and widely used in many devices such as telephone, network, analog communication, digital communication, cable TV and satellite antenna. For all the input port, especially those from the outdoor, you need to install the signal lightning arrester.
- Antenna feed cable lightning arrester: It is suitable for antenna system of the transmitter or the device system to receive the wireless signal. It uses the serial connection too.

Please note, when you select the lightning arrester, please pay attention to the port type and the earthing reliability. In some important environment, you need to use special shielded cable. Do not parallel connect the thunder proof ground cable with the ground cable of the lightning rod. Please make sure they are far enough and grounded respectively.

2. The earthing modes

We all know the earthing is the most complicated technology in the electromagnetism compatibility design since there is no systematic theory or module. The earthing has many modes, but the selection depends on the system structure and performance. The following are some successfully experience from our past work.

One-point ground: In the following figure you can see there is a one-point ground. This connection provides common port to allow signal to be transmitted in many circuits. If there is no common port, the error signal transmission occurred. In the one-point ground mode, each circuit is just grounded only and they are connected at the same port. Since there is only one common port, there is no circuit and so, there is no interference.

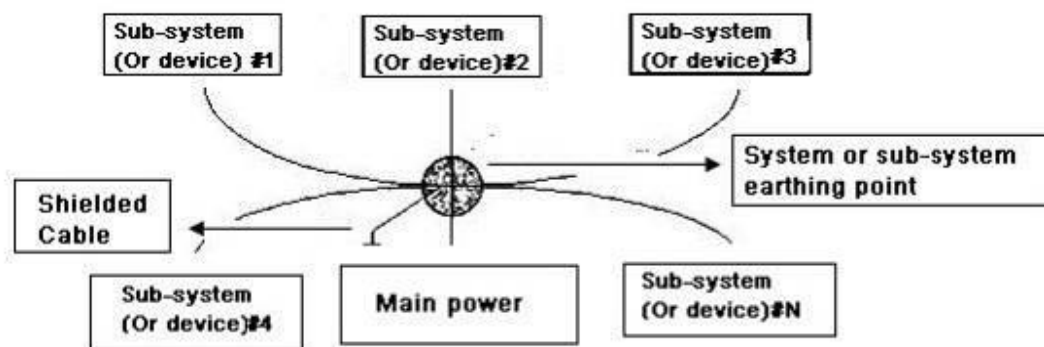

Multiple-point ground: In the following figure, you can see the internal circuit uses the chassis as the common point. While at the same time, all devices chassis use the earthing as the common port. In this connection, the ground structure can provide the lower ground resistance because when there are multiple-point grounds; each ground cable is as short as possible. And the parallel cable connection can reduce the total

conductance of the ground conductor. In the high-frequency circuit, you need to use the multiple-point ground mode and each cable needs to connect to the ground. The length shall be less than the 1/20 of the signal wavelength.

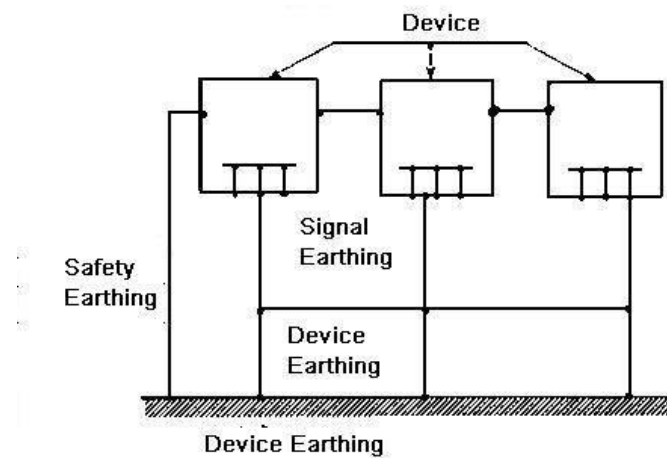

Mixed ground: The mixed ground consists of the feature of the one-point ground and multiple-point ground. For example, the power in the system needs to use the one-point ground mode while the radio frequency signal requires the multiple-point ground. So, you can use the following figure to earth. For the direct current (DC), the capacitance is open circuit and the circuit is one-point ground. For the radio frequency signal, the capacitance is conductive and the circuit adopts multiple-point ground.

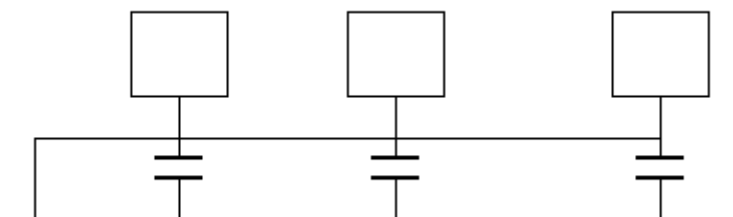

When connecting devices of huge size (the device physical dimension and connection cable is big comparing with the wave path of existed interference), then there are possibility of interference when the current goes through the chassis and cable. In this situation, the interference circuit path usually lies in the system ground circuit.

When considering the earthing, you need to think about two aspects: The first is the system compatibility, and the other is the external interference coupling into the earth circuit, which results in system error. For the external interference is not regular, it is not easy to resolve.

3. Thunder proof ground method in the monitor system

- The monitor system shall have sound thunder proof earthing to guarantee personnel safety and device safety.
- The monitor system working ground resistance shall be less than 1Ω.

- The thunder proof ground shall adopt the special ground cable from the monitor control room to the ground object. The ground cable adopts copper insulation cable or wire and its ground section shall be more than 20mm².
- The ground cable of the monitor system can not short circuit or mixed connected with the strong alternative current cable.
- For all the ground cables from the control room to the monitor system or ground cable of other monitor devices, please use the copper resistance soft cable and its section shall be more than 4mm².
- The monitor system usually can adopt the one-point ground.
- Please connect the ground end of 3-pin socket in the monitor system to the ground port of the system (protection ground cable)

4. The shortcut way to check the electric system using the digital multimeter

For 220V AC socket, from the top to the bottom, E (ground cable), N (neutral cable), L(live cable). Please refer to the following figure.

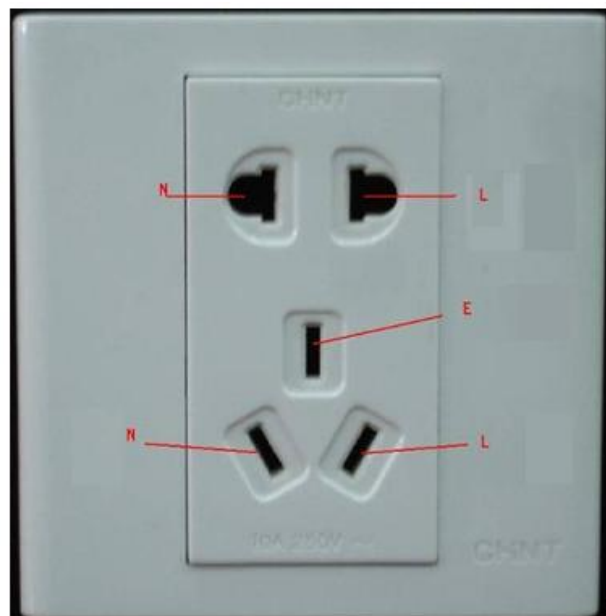

There is a shortcut way to check these three cables connection are standard or not (not the accurate check).

Importance

In the following operations, the multimeter range shall be at 750V!

For E (earth cable)

Turn the digital multimeter to 750V AC, use your one hand to hold the metal end, and then the other hand insert the pen to the E port of the socket. See the following figure. If the multimeter shows 0, then you can see current earth cable connection is standard. If the value is more than 10, then you can see there is inductive current and the earth cable connection is not proper.

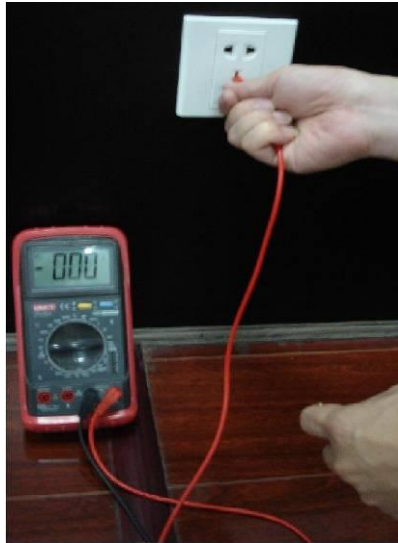

For L (live cable)

Turn the digital multimeter to 750V AC, use your one hand to hold the metal end, and then the other hand insert the pen to the L port of the socket. See the following figure. If the multimeter shows 120, then you can see current live cable connection is standard. If the value is less than 60, then you can see current live cable connection is not proper or it is not the live cable at all.



For N (Neutral cable)

Turn the digital multimeter to 750V AC, use your one hand to hold the metal end, and then the other hand insert the pen to the N port of the socket. See the following figure. If the multimeter shows 0, then you can see current N cable connection is standard. If the value is more than 10, then you can see there is inductive current and the neutral cable connection is not proper. If the value is 120, then you can know misconnected the neutral cable to the live cable.

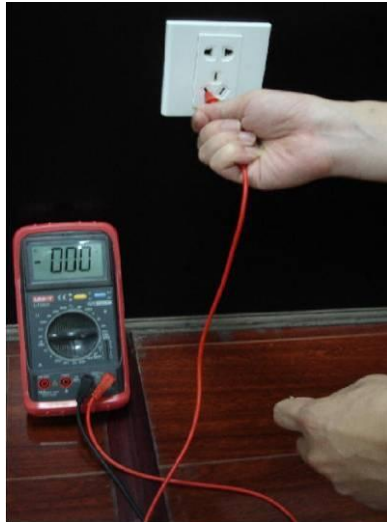

Appendix H Toxic or Hazardous Materials or Elements

Component Name	Toxic or Hazardous Materials or Elements					
	Pb	Hg	Cd	Cr VI	PBB	PBDE
Sheet Metal(Case)	○	○	○	○	○	○
Plastic Parts (Panel)	○	○	○	○	○	○
Circuit Board	○	○	○	○	○	○
Fastener	○	○	○	○	○	○
Wire and Cable/AC Adapter	○	○	○	○	○	○
Packing Material	○	○	○	○	○	○
Accessories	○	○	○	○	○	○

O: Indicates that the concentration of the hazardous substance in all homogeneous materials in the parts is below the relevant threshold of the SJ/T11363-2006 standard.

X: Indicates that the concentration of the hazardous substance of at least one of all homogeneous materials in the parts is above the relevant threshold of the SJ/T11363-2006 standard. During the environmental-friendly use period (EFUP) period, the toxic or hazardous substance or elements contained in products will not leak or mutate so that the use of these (substances or elements) will not result in any severe environmental pollution, any bodily injury or damage to any assets. The consumer is not authorized to process such kind of substances or elements, please return to the corresponding local authorities to process according to your local government statutes.

Note:

- **This manual is for reference only. Slight difference may be found in the user interface.**
- **All the designs and software here are subject to change without prior written notice.**
- **All trademarks and registered trademarks mentioned are the properties of their respective owners.**
- **If there is any uncertainty or controversy, please refer to the final explanation of us.**
- **Please visit our website or contact your local retailer for more information.**